



passion for precision
[Leidenschaft für Präzision]

Ihre Kunden-Nummer
Your Account Number



Wir sind Spanabhebende Präzisionswerkzeuge GmbH, ein Familienunternehmen mit Sitz in Lich in Hessen. Seit 1963 sind wir auf die Vermarktung und Entwicklung von Hochleistungswerkzeugen für die Zerspaltung spezialisiert. Mit der Erfahrung aus fast sechzig Jahren haben wir alle Entwicklungen bei der Zerspaltung maßgeblich begleitet.

Unsere Sachkenntnis und unsere gemeinsame Sprache mit den Anwendern der Zerspaltung machen uns zum kompetenten Lösungspartner in der Präzisions- und Hochleistungsbearbeitung.

Bei uns erhalten Sie nicht nur Werkzeuge, wir schnüren Ihnen ein komplettes, individuelles Produktpaket. Darin enthalten sind Beratung, Liefertreue, Preis-Leistungs-Verhältnis und moderne Logistik. Zusätzlich profitieren Sie von unserem persönlichen Service, schlanken Geschäftsprozessen, Beschaffungs- und Tool-Management.

Erstklassige Beratung, beste Qualität und individuelle Lösungen sind unser Anspruch und unser Versprechen an Sie.

passion for precision

[Leidenschaft für Präzision]

Präzisionswerkzeuge Katalog Version J59

Mit Erscheinen dieses Kataloges verlieren alle
bisherigen Kataloge und Preislisten ihre Gültigkeit.

Precision Cutting Tools Catalog Version J59

All previous catalogs and price lists become invalid
with publication of this catalog.

Alle in diesem Katalog enthaltenen Texte, Darstellungen, Abbildungen und Zeichnungen sind Eigentum der Spanabhebende Präzisionswerkzeuge GmbH und damit urheberrechtlich geschützt. Kein Teil dieses Katalogs darf in irgendeiner Form ohne unsere schriftliche Genehmigung reproduziert oder unter Verwendung elektronischer Systeme verändert, verarbeitet, vervielfältigt oder verbreitet werden. Wir behalten uns das Recht vor, diese Genehmigung jederzeit zu widerrufen. Spanabhebende Präzisionswerkzeuge GmbH übernimmt keine Gewähr dafür, dass die bereitgestellten Informationen vollständig, richtig und in jedem Fall aktuell sind. Zudem behalten wir uns das Recht vor, ohne vorherige Ankündigung, Änderungen, Löschungen oder Ergänzungen der bereitgestellten Informationen vorzunehmen. In keinem Fall haften wir für Schäden, einschließlich entgangener Gewinne, die zufällig oder als Konsequenz aus der Verwendung der Dokumente oder Informationen resultieren. Sortimentsänderungen, technische Weiterentwicklung sowie Druckfehler und Irrtümer behalten wir uns vor. Lich, im November 2021.

All texts, representations, pictures and illustrations in this catalog are the intellectual property of Spanabhebende Präzisionswerkzeuge GmbH and thus protected by law. No part of this catalog may be reproduced, modified, electronically processed, duplicated or distributed in any way without our written consent. We reserve the right to revoke this consent at any time. Spanabhebende Präzisionswerkzeuge GmbH does not guarantee, that the information provided in this document is complete, free of error and up-to-date in every case. We reserve the right to delete and/or modify the information without prior notice. Spanabhebende Präzisionswerkzeuge GmbH can not be made liable for any damage, including lost earnings, that result directly or indirectly from the use of the information provided in this catalog. We reserve the right to make changes to our product range. Our offer is subject to change, technical developments as well as printing errors and mistakes. Lich, November 2021.

Liebe Geschäftsfreunde und Kunden!

In den letzten Jahren haben wir unsere Prozesse und unsere Infrastruktur kontinuierlich verbessert - und es geht weiter, damit wir auch in Zukunft zukunftsfähig sind.

Es gehört zu unserer DNS natürlichen Ressourcen zu schonen. Die Verantwortung für den Menschen und unsere Umwelt sind dabei unser Maßstab:

- langfristige Beziehungen zu unseren Partnern und Kunden,
- hochwertige Produkte,
- Problemlösungen auf Augenhöhe und
- Nachhaltigkeit in unseren Beziehungen zu Mitmenschen und Natur.

Mit großer Freude stelle wir Ihnen unseren Katalog J59 vor. Über 30.000 Präzisionswerkzeuge, viele davon Innovationen und Problemlöser, die Sie nur bei uns finden.

Wir freuen uns auf Sie und unsere gemeinsame Zusammenarbeit.



Oliver Meineke



Dear partners and friends!

In the past years, we have consistently improved our business processes and our infrastructure. And we are continuing to do so in order to remain fit for the future.

Protecting natural resources is part of our DNA. Responsibility for people and our environment are our standards:

- long-term relationships with our partners and customers,
- high-quality products,
- problem solving at eye level and
- sustainable interaction with our fellow humans and nature.

We are pleased to present you our catalog J59.

With over 30,000 precision tools, many of them innovations and problem solvers, which you will find only with us.

We are looking forward to work with you.



Oliver Meineke

Wichtige Informationen

Lieferungen

Alle Bestellungen, die bis 16:00 Uhr eingehen, werden am selben Tag an unsere Logistikpartner übergeben.

Alle Lieferungen erfolgen ab Werk zu günstigen Versandpauschalen. Auf Wunsch bieten wir Express- und Wochenend-Service an. Den Aufpreis teilen wir Ihnen auf Anfrage gerne mit.

Bei Kleinstaufträgen unter EUR 50,00 behalten wir uns vor, einen Mindermengenzuschlag zu berechnen.

Export

Für Teile unseres Produktprogramms können Ausfuhrbeschränkungen bestehen. Die Ausfuhr dieser Produkte erfolgt nur nach Erteilung aller notwendigen Genehmigungen.

AGB

Unsere Allgemeinen Geschäftsbedingungen finden Sie im Internet unter: www.sppw.de/de/agb

Nebensortimente und Sonderwerkzeuge

Sollten Sie Ihr benötigtes Werkzeug nicht in unserem Katalog finden - kein Problem. Wir haben ein umfangreiches Nebensortiment mit vielen weiteren Produkten. Besondere Werkzeuglösungen fertigen wir für Sie an. Entweder als abgeänderter Standard oder als komplette Neuanfertigung. Fragen Sie an, wir beraten Sie gerne.



Important Information

Deliveries

All orders passed before 16:00 will be handed over to our logistics partner the same day.

All shipments are made "Ex Works" with UPS at their indicated rates. Express service is available on request. Please inquire for tariffs and availability to your country. If you have a specific carrier you wish to use, we can ship the goods at your cost on your account number.

Minimum amount for export orders is EUR 200,00 net. All taxes and duties as well as bank charges are to be paid by the customer.

Export

Some products may be subject to export control by the German Federal Office of Economics and Export Control. These can only be supplied after export has been cleared.

Terms and Conditions

Our general terms and conditions can be found on our website: www.sppw.de/en/terms

Additional Products and Special Tooling

If you are looking for a specific tool and did not find it in our catalog, we have a wide range of additional products that are not listed.

If you are looking for special tooling, please inquire. We produce special tools based on our standards or completely according to your specification. Please contact us.



Gemeinsam mehr erreichen

Die Wahl des richtigen Partners hängt von vielen Faktoren ab und ist entscheidend für den Erfolg.

Nachhaltige Geschäftsbeziehungen bedeuten mehr als gute Produkte zu einem fairen Preis.

Partnerschaft bedeutet für uns, miteinander Rationalisierungspotenziale auszuschöpfen und Innovationen voranzubringen.

Dazu gehen wir über Standards hinaus und begleiten Sie entlang Ihrer Wertschöpfungskette.

Wir vergleichen permanent Ihre Anforderungen mit den Entwicklungen auf verschiedenen Märkten und den Erfahrungen unserer Partner.

Aus diesem Know-How-Netzwerk mit Partnern, Forschungseinrichtungen und Kunden beziehen wir unsere Innovation.

Unser Qualitätsanspruch, gepaart mit dem gesamten Know-How in Entwicklung, Fertigung und Service unterstreicht die Führungsrolle unserer Partner in verschiedensten Bereichen.



Achieving more together

The choice of the right partner depends on many factors and is crucial for success.

Sustainable business relationships are no longer just about good products at a fair price.

Lasting partnership is discovering and making use of rationalization and innovation potentials to a mutual benefit.

Therefore we constantly compare your requirements with the trends on different markets and the expertise of our partners.

We draw our innovation from this know-how network with partners, research institutes and customers.

Highest quality standards, combined with the our know-how

in engineering, manufacturing and service, underline the leading role of our partners in various fields.

This is how we innovate.



Mehr als Präzisionswerkzeuge

Alle Industriebereiche benötigen heute Zerspanungswerkzeuge, um in immer höherer Präzision Produkte und Technologien zu realisieren. Die Ansprüche an die Zerspanungstechnik sind dabei stetig gewachsen und heute differenzierter denn je.

Mit der Erfahrung aus fast sechzig Jahren haben wir diese Entwicklung seit 1963 maßgeblich begleitet.

Unsere Sachkenntnis und eine gemeinsame Sprache mit den

Anwendern haben uns am Markt zum kompetenten Ansprechpartner für Lösungen in der Präzisions- und Hochleistungszerspanung gemacht.

Bei uns erhalten Sie nicht nur Werkzeuge, wir schnüren ein komplettes, individuelles Produktpaket für Sie. Darin enthalten sind Beratung, Preis-Leistungs-Verhältnis und moderne Logistik.

Zusätzlich profitieren Sie von unserer erstklassigen Beratung, beste Qualität und individuelle

Lösungen sind unser Anspruch und unser Versprechen.

Unsere Leidenschaft für Präzision als Basis für Ihren wirtschaftlichen Erfolg.

Unser Produktprogramm - alles Wesentliche um

- Bohren
- Zentrieren
- Reiben
- Senken
- Fräsen
- Gewinden



More than just cutting tools

Today all industrial sectors need cutting tools to satisfy their growing demand for high technology products.

The specifications of cutting tools have evolved and now are more varied than ever.

With nearly 60 years of experience in this field we have accompanied this development since 1963.

Know-how and a common language with our customers have made us the competent partner for

solutions in precision and high performance cutting.

Not cutting tools only; we create a unique product for each customer from the elements tool-consulting, dependability, cost-performance ratio and modern logistics.

Additionally our customers can benefit from our individual service: e-business processes, procurement solutions and tool management.

First class consulting, best quality and individual solutions are our claim and our promise.

Make of our passion for precision the foundation for your success.

Our product range - essential tools for

- Drilling
- Centering
- Reaming
- Sinking
- Milling
- Threading

Das Programm für höchste Ansprüche in jeder Größe

Unsere Präzisionswerkzeuge zeichnen sich durch höchste Leistungsfähigkeit auch unter härtesten Bedingungen aus. Alle Werkzeuge unterliegen einer durchgängigen Qualitätssicherung.

Dadurch gewährleisten wir eine gleich bleibend hohe Qualität auf dem jeweils aktuellen Stand der Technik.

Neben dem klassischen Werkzeugprogramm haben wir uns auf technologieintensive Nischenbereiche mit Innovations- und Wachstumspotential spezialisiert.

Unser besonderes Augenmerk gilt dabei hochdynamischen Bereichen wie der Microzerspanung, dem Fräsen von gratfreien Gewinden, der Bearbeitung von Faserverbundwerkstoffen und exotischen Materialien sowie der Multifunktionszerspanung.

Für diese Felder haben wir besondere Konzepte entwickelt, z.B. das Multiform-Microtools. Es umfasst verschiedene Werkzeuge für ein breites Bearbeitungsspektrum in der Microzerspanung zum Fräsen, Bohren, Senken und Reiben.

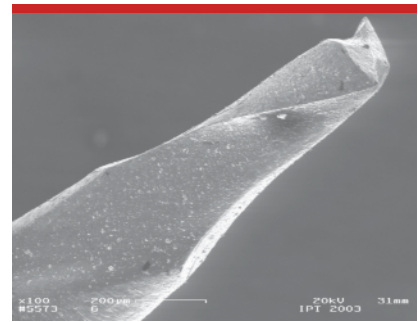

Tools for highest requirements in all sizes

Our precision tools excel with highest performance under the toughest working conditions. All tools are checked according to an integrated quality system. Thus we can assure a continuous, high quality level and state of the art technology.

In addition to our standard tool range we also specialize in high technology niches with high innovation and growth potential.

Our special focus is on highly dynamic segments like micro tooling, burrfree milling of threads, machining of fibre composites and exotic materials as well as multifunctional machine tools.

For these segments we have developed special machining concepts, like the idea of Multiform-Micro-Tools, where we combine several kinds of micro and mini tools like micro end mills, micro drills and micro reamers.



Beratung, Service und Systemlösungen in allen Dimensionen

Die Basis für individuelle Zerspanungslösungen sind unser breites Produktprogramm und unsere einzigartige Betreuungs- und Problemlösungskompetenz.

Immer neue Kundenanforderungen aus verschiedenen Anwendungsbereichen stellen für uns jeden Tag eine Herausforderung dar.

Hohe Reaktionsgeschwindigkeit, schnelle Bemusterung, hervorragende Qualität und unsere langjährige Erfahrung wissen unsere Kunden zu schätzen.

Mit über 30.000 Qualitätswerkzeugen für die Zerspanung bieten wir ein umfassendes Programm an Bohrern, Fräsern, Reibahlen, Senkern und Gewindewerkzeugen - Innovative Lösungen für (fast) jede Zerspanungsaufgabe.

Neben der klassischen Anwendungsberatung entwickeln wir gemeinsam mit Ihnen, im Rahmen von Design, Konstruktion und Prozessauslegung, Lösungen und Verfahrensweisen für Ihre Fertigung.

Die persönliche Beratung steht dabei im Vordergrund, denn die besten Lösungen finden wir nur gemeinsam mit Ihnen.

Dank langjähriger Erfahrung erkennen unsere Experten schnell, wie wir Sie individuell unterstützen können; Auswahl von Werkzeugen, Einsatzstrategien, Standzeiten, höhere Produktivität und mehr.



- Elektronische Produktinformation
- Daten / WWS-Lösungen
- Integriertes Bestell- und Verwaltungsmanagement
- Individuelle, integrierte Beschaffungskonzepte
- Persönliche Beratung
- Flexibilität

Technical expertise, service and integrated solutions in all dimensions

The basis for individual tooling solutions is our broad product range and our problem solving competence.

Most customers work within their very niche areas of activity and have thus very specialised demands. However that does not pose a problem to us, we like the challenge. Fast reactions, excellent quality and long time experience are highly valued by our customers.

With more than 30,000 quality cutting tools we offer an extended product range for drilling, milling, reaming, chamfering and threading.

We have innovative solutions for all kinds of tooling applications. In addition to normal tool consulting we offer early stage involvement

in our customers' production process, minimizing costs from the design board.

We put our emphasis on the personal contact and personal advice. Longtime experience enables our cutting tool experts to help you on an individual basis with the choice and use tools, tooling strategies, tool life, higher productivity and more.

- Electronic product information
- Data / ERP solutions
- Integrated ordering and administration
- Individual procurement solutions
- Individual advice

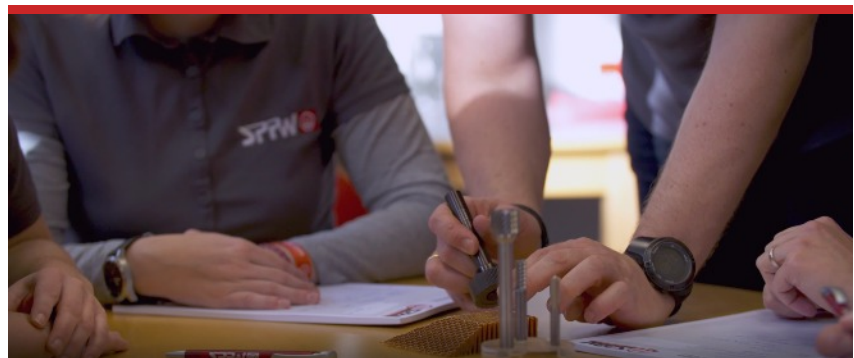



[DE] **Zentrieren**
[EN] **Centering**









passion for precision
[Leidenschaft für Präzision]



Zentrierbohrer VHM

Carbide Center Drills









Art.No./Page

●	●		○	●		VHM	blank	DIN 333	Form A	60°	623 360 Seite A 1
●	●		○	●		VHM	X Cut	DIN 333	Form A	60°	623 367 Seite A 1
●	●		○	●		VHM	X Cut	Form A	60°	OAL 100	623 537 Seite A 2
●	●		○	●		VHM	X Cut	Form A90	90°		623 267 Seite A 2
●	●		○	●		VHM	blank	DIN 333	Form R	Radius	623 370 Seite A 3
●	●		○	●		VHM	X Cut	DIN 333	Form R	Radius	623 377 Seite A 3

Zentrierbohrer HSS

HSS Center Drills



Art.No./Page

●	●		○			HSS	blank	DIN 333	Form A	60°	123 110 Seite A 4
●	●		○			HSS	blank	DIN 333	Form A	60°	LH links 123 180 Seite A 4
●	●		○			HSS	blank	DIN 333	Form A	60°	123 130 Seite A 5
●	●		○			HSS	blank	DIN 333	Form W	60°	123 140 Seite A 6
●	●		○			HSS	blank	DIN 333	Form A90	90°	123 260 Seite A 6
●	●		○			HSS	blank	DIN 333	Form R	Radius	123 160 Seite A 7
●	●		○			HSS	blank	DIN 333	Form R	Radius	LH links 123 210 Seite A 7
●	●		○			HSS	blank	DIN 333	Form B	60° 120°	123 230 Seite A 8
●	●		○			HSS	blank	DIN 333	Form B	60° 120°	LH links 123 200 Seite A 8

Zentrierbohrer HSS-E

HSS-E Center Drills

Art.No./Page

●	●		○			HSS E05	blank	DIN 333	Form A	60°	123 340 Seite A 9
●	●	●	○	○		HSS E05	A Cut	DIN 333	Form A	60°	123 350 Seite A 9

●	●	●	○	○		HSS E05	X Cut	DIN 333	Form A	60°	123 490 Seite A 10
●	●	●		○		HSS E05	blank	Form A	60°	L lang	123 520 Seite A 11
●	●	●		○		HSS E05	blank	Form A	60°	L lang	123 530 Seite A 11
●	●	●		○		HSS E05	blank	Form A	60°	L lang	123 540 Seite A 11
●	●	●		○		HSS E05	blank	Form A	60°	L lang	123 510 Seite A 11
●	●	●		○		HSS E05	blank	Form A	60°	L lang	123 550 Seite A 11
●		●		○		HSS E05	blank	DIN 333	Form A	60° FLAT	123 290 Seite A 12
●	●	●	○	○		HSS E05	A Cut	DIN 333	Form A	60° FLAT	123 296 Seite A 12
●		●		○		HSS E05	blank	DIN 333	Form R	Radius FLAT	123 280 Seite A 13
●	●	●	○	○		HSS E05	A Cut	DIN 333	Form R	Radius FLAT	123 286 Seite A 13
●		●		○		HSS E05	blank	DIN 333	Form B	60°/120° FLAT	123 300 Seite A 14
●	●	●	○	○		HSS E05	A Cut	DIN 333	Form B	60°/120° FLAT	123 306 Seite A 14

Zentrierbohrer Pulvermetall

Powdermetal Center Drills

Art.No./Page

●	●	●	○	○		HSS PM	X Cut	DIN 333	Form A	60°	123 480 Seite A 10
---	---	---	---	---	---	--------	-------	---------	--------	-----	-----------------------

Stufenzentrierbohrer HSS-E05

HSS-E05 Step Center Drills

Art.No./Page

●	●	●		○		HSS E05	blank	DIN 332-2	Form D	60°/90° FLAT	123 420 Seite A 15
●	●	●				HSS E05	blank	DIN 332-2	Form D	60°/90° ZYL	123 620 Seite A 15
●	●	●				HSS E05	blank	DIN 332-2	Form DR	Radius 90° FLAT	123 650 Seite A 16
●	●	●				HSS E05	blank	DIN 332-2	Form DR	Radius 90° ZYL	123 630 Seite A 16
●	●	●				HSS E05	blank	DIN 332-2	Form DS	60°/120°/90° FLAT	123 670 Seite A 17
●	●	●				HSS E05	blank	DIN 332-2	Form DS	60°/120°/90° ZYL	123 660 Seite A 17

623 360

Zentrierbohrer VHM DIN 333 Form A

Carbide Center Drills DIN 333 Form A



- Zentrierbohrungen DIN 332 A
- Hohe Zerspanungsleistung
- Form A: Senkwinkel 60°
- Ø0,5 und Ø0,8 einseitig
- Oberfläche blank

- Centers DIN 332 A
- High performance
- Form A: Chamfering angle 60°
- Ø0,5 and Ø0,8 single end
- Bright finish

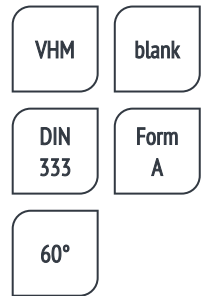

Ød k12	ØD h6	L	l1 von	l1 bis	Art. No.	Ød k12	ØD h6	L	l1 von	l1 bis	Art. No.
0,5	3,15	25	0,6	0,9	6233600050	2,5	6,3	45	3,1	3,8	6233600250
0,8	3,15	25	1	1,3	6233600080	2,5	8	50	3,1	3,8	6233600258
1	3,15	31	1,3	1,7	6233600100	3	8	50	3,9	4,6	6233600300
1	4	35	1,3	1,7	6233600104	3	10	55	3,9	4,6	6233600310
1,25	3,15	31	1,6	2	6233600125	3,15	8	50	3,9	4,6	6233600315
1,5	5	40	2	2,6	6233600150	4	10	55	5	5,9	6233600400
1,6	4	35	2	2,6	6233600160	5	12,5	63	6,3	7,2	6233600500
2	5	40	2,5	3,1	6233600200	5	12	63	6,3	7,2	6233600512
2	6	45	2,5	3,1	6233600206	6,3	16	71	8	8,9	6233600630

623 367

Zentrierbohrer VHM+X.Cut DIN 333 Form A

Carbide Center Drills+X.Cut DIN 333 Form A



- Zentrierbohrungen DIN 332 A
- Hohe Zerspanungsleistung
- Form A: Senkwinkel 60°
- Ø0,5 und Ø0,8 nur einseitig
- Oberfläche X.Cut beschichtet

- Centers DIN 332 A
- High performance
- Form A: Chamfering angle 60°
- Ø0,5 and Ø0,8 single end
- With X.Cut coating

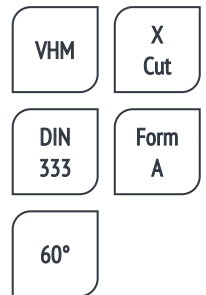
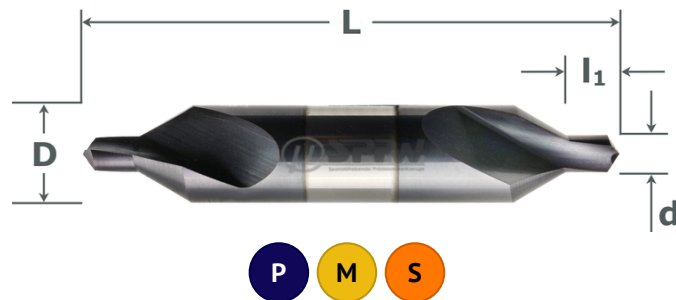

Ød k12	ØD h6	L	l1 von	l1 bis	Art. No.	Ød k12	ØD h6	L	l1 von	l1 bis	Art. No.
0,5	3,15	25	0,6	0,9	6233670050	2,5	6,3	45	3,1	3,8	6233670250
0,8	3,15	25	1	1,3	6233670080	2,5	8	50	3,1	3,8	6233670258
1	3,15	31	1,3	1,7	6233670100	3	8	50	3,9	4,6	6233670300
1	4	35	1,3	1,7	6233670104	3	10	55	3,9	4,6	6233670310
1,25	3,15	31	1,6	2	6233670125	3,15	8	50	3,9	4,6	6233670315
1,5	5	40	2	2,6	6233670150	4	10	55	5	5,9	6233670400
1,6	4	35	2	2,6	6233670160	5	12,5	63	6,3	7,2	6233670500
2	5	40	2,5	3,1	6233670200	5	12	63	6,3	7,2	6233670512
2	6	45	2,5	3,1	6233670206	6,3	16	71	8	8,9	6233670630

623 537**Zentrierbohrer VHM+X.Cut Form A Lang
Carbide Center Drills Form A Long Series****A**

- Lange Ausführung - 100 mm
- Zentrierungen mit Zugangsproblemen
- Hohe Zerspanungsleistung
- DIN 332 A: Senkwinkel 60°
- Oberfläche X.Cut beschichtet

- Long version - 100 mm
- Centers with access problems
- High performance
- Form A: Chamfering angle 60°
- With X.Cut coating

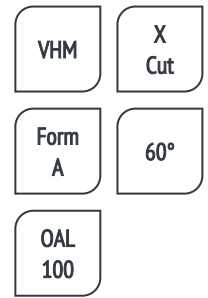

Ød k12	ØD h6	L	l1 von	l1 bis	Art. No.
1	4	100	1,3	1,7	6235370100
2	6	100	2,5	3,1	6235370200

Ød k12	ØD h6	L	l1 von	l1 bis	Art. No.
3	8	100	3,9	4,6	6235370300
4	10	100	5	5,9	6235370400

623 267**Zentrierbohrer VHM+X.Cut Form A 90°
Carbide Center Drills Form A 90°**

- Zentrierbohrungen 90°
- Hohe Zerspanungsleistung
- Senkwinkel 90°
- Oberfläche X.Cut beschichtet

- Centers with 90°
- High performance
- Chamfering angle 90°
- With X.Cut coating

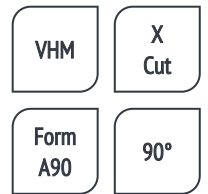

Ød k12	ØD h6	L	l1 von	l1 bis	Art. No.
1	4	35	1,3	1,7	6232670100
2	6	45	2,5	3,1	6232670200

Ød k12	ØD h6	L	l1 von	l1 bis	Art. No.
3	8	50	3,9	4,6	6232670300
4	10	55	5	5,9	6232670400

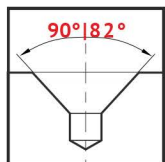
— INFO

- Senkwinkel 90° mit geraden Laufflächen Form A
- Senkwinkel 82° für Anwendungen im Flugzeugbau auf Anfrage
- Vollhartmetall für hohe Produktivität
- Chamfering angle 90°
- Chamfering angle 82° for aeronautic applications on request
- Carbide for highest productivity

623 370

Zentrierbohrer VHM DIN 333 Form R

Carbide Center Drills DIN 333 Form R



- Radius-Zentrierbohrungen DIN 332 R
- Hohe Zerspanungsleistung
- Verbesserter Sitz des Werkstücks
- Hohe Stabilität durch Radius
- Ø0,5 nur einseitig
- Oberfläche blank

- Radial centers acc. DIN 332 R
- High performance
- Stronger tool due to radial transition
- Better alignment of work piece
- Ø0,5 single end
- Bright finish

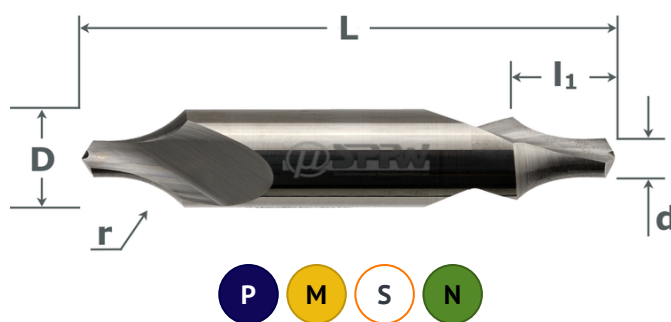

Ød k12	ØD h6	L	l1 von	l1 bis	r Radius	Art. No.
0,5	3,15	25	2,3	2,6	2	6233700050
1	3,15	31	3	3,3	2,9	6233700100
1,25	3,15	31	3,3	3,6	3,15	6233700125
1,6	4	35	4,2	4,7	4	6233700160
2	5	40	5	5,4	5	6233700200

Ød k12	ØD h6	L	l1 von	l1 bis	r Radius	Art. No.
2,5	6,3	45	6,3	6,8	6,3	6233700250
3,15	8	50	8	8,5	8	6233700315
4	10	55	10	10,6	10	6233700400
5	12,5	63	12,5	13,1	12,5	6233700500

623 377

Zentrierbohrer VHM+X.Cut DIN 333 Form R

Carbide Center Drills+X.Cut DIN 333 Form R



- Radius-Zentrierbohrungen DIN 332 R
- Hohe Zerspanungsleistung
- Verbesserter Sitz des Werkstücks
- Hohe Stabilität durch Radius
- Ø0,5 nur einseitig
- Oberfläche X.Cut beschichtet

- Radial centers acc. DIN 332 R
- High performance
- Stronger tool due to radial transition
- Better alignment of work piece
- Ø0,5 single end
- With X.Cut coating



Ød k12	ØD h6	L	l1 von	l1 bis	r Radius	Art. No.
0,5	3,15	25	2,3	2,6	2	6233770050
1	3,15	31	3	3,3	2,9	6233770100
1,25	3,15	31	3,3	3,6	3,15	6233770125
1,6	4	35	4,2	4,7	4	6233770160
2	5	40	5	5,4	5	6233770200

Ød k12	ØD h6	L	l1 von	l1 bis	r Radius	Art. No.
2,5	6,3	45	6,3	6,8	6,3	6233770250
3,15	8	50	8	8,5	8	6233770315
4	10	55	10	10,6	10	6233770400
5	12,5	63	12,5	13,1	12,5	6233770500

— INFO

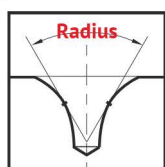

Bei Form R ist der Kegelwinkel als Radius ausgeführt. Der Übergang von der Werkzeugspitze in den Schaft ist hier graduell, was den Zentrierbohrer wesentlich stabiler macht. HSS Zentrierbohrer sind auch in langer Ausführung lieferbar.

In form R, the taper angle is executed as a radius. The transition from the tool tip to the shank is gradual, which makes the center drill much more rigid. Also available in long version.

123 110

Zentrierbohrer HSS DIN 333 Form A HSS Center Drills DIN 333 Form A



A

- Zentrierbohrungen DIN 332 A
- Hohe Rundlaufgenauigkeit
- Form A: Senkwinkel 60°
- Ø0,5-0,8 nur einseitig
- Oberfläche blank

- Centers DIN 332 A
- High concentricity and precision
- Form A: Chamfering angle 60°
- Ø0,5-Ø0,8 single end
- Bright finish

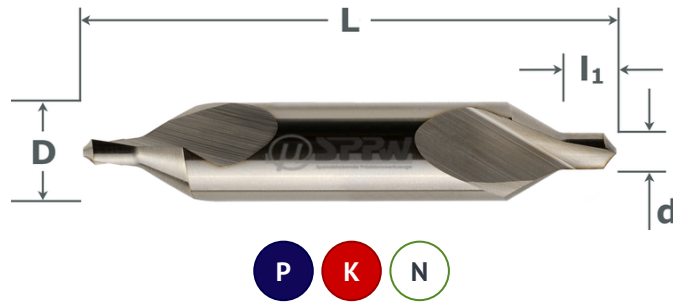

HSS	blank
DIN 333	Form A
60°	

Ød k12	ØD h7	L	l1 von	l1 bis	Art. No.	Ød k12	ØD h7	L	l1 von	l1 bis	Art. No.
0,50	3,15	25	0,6	0,9	1231100050	2,50	8,00	50	3,1	3,8	1231100258
0,63	3,15	25	0,7	1,0	1231100063	3,15	10,0	55	3,9	4,6	1231100311
0,80	3,15	25	1,0	1,3	1231100080	3,15	8,00	50	3,9	4,6	1231100315
1,00	3,15	31	1,3	1,7	1231100100	4,00	10,0	55	5,0	5,9	1231100400
1,00	4,00	35	1,3	1,7	1231100104	4,00	12,5	63	5,0	5,9	1231100412
1,25	4,00	35	1,6	2,0	1231100124	5,00	12,5	63	6,3	7,2	1231100500
1,25	3,15	31	1,6	2,0	1231100125	6,30	16,0	71	8,0	8,9	1231100630
1,60	4,00	35	2,0	2,6	1231100160	6,30	20,0	80	8,0	8,9	1231100632
1,60	5,00	40	2,0	2,6	1231100165	8,00	20,0	80	10,1	11,1	1231100800
2,00	5,00	40	2,5	3,1	1231100200	8,00	25,0	100	10,1	11,1	1231100825
2,00	6,00	45	2,5	3,1	1231100201	10,0	25,0	100	12,8	13,8	1231101000
2,00	6,30	45	2,5	3,1	1231100206	10,0	31,5	125	12,8	13,8	1231101031
2,50	6,30	45	3,1	3,8	1231100250	12,5	31,5	125	16,5	17,5	1231101250

123 180

Zentrierbohrer HSS DIN 333 Form A Links HSS Center Drills DIN 333 Form A Left Hand



- Zentrierbohrungen DIN 332 A
- Linksschneidend für Drehmaschinen
- Hohe Rundlaufgenauigkeit
- Ø0,5 - Ø0,8 nur einseitig
- Oberfläche blank

- Centers DIN 332 A
- Left hand cutting - for lathes
- High concentricity and precision
- Form A: Chamfering angle 60°
- Ø0,5 - Ø0,8 single end
- Bright finish

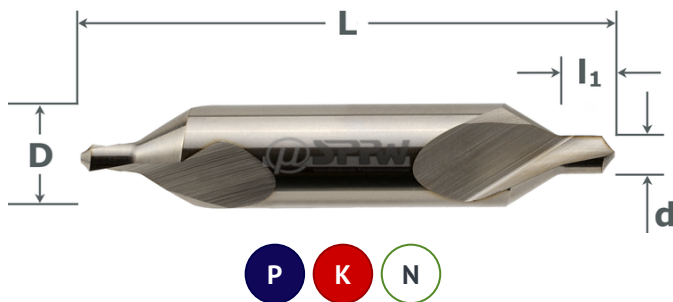

HSS	blank
DIN 333	Form A
60°	LH links

Ød k12	ØD h7	L	l1 von	l1 bis	Art. No.	Ød k12	ØD h7	L	l1 von	l1 bis	Art. No.
0,5	3,15	25	0,6	0,9	1231800050	2,5	6,3	45	3,1	3,8	1231800250
0,63	3,15	25	0,7	1	1231800063	2,5	8	50	3,1	3,8	1231800258
0,8	3,15	25	1	1,3	1231800080	3,15	8	50	3,9	4,6	1231800315
1	3,15	31	1,3	1,7	1231800100	4	10	55	5	5,9	1231800400
1,25	3,15	31	1,6	2	1231800125	5	12,5	63	6,3	7,2	1231800500
1,6	4	35	2	2,6	1231800160	6,3	16	71	8	8,9	1231800630
2	5	40	2,5	3,1	1231800200	8	20	80	10,1	11,1	1231800800
2	6,3	45	2,5	3,1	1231800206						



- Zentrierbohrungen DIN 332 A
- Nicht genormte Sonderabmessungen
- Hohe Rundlaufgenauigkeit
- Senkwinkel 60°
- Oberfläche blank

- Centers DIN 332 A
- Non-standardized dimensions
- High concentricity and precision
- Form A: Chamfering angle 60°
- Bright finish

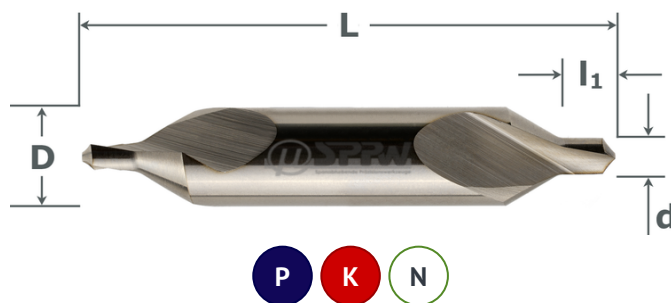

123130 - Sonderabmessungen | Special Dimensions

Ød k12	ØD h7	L	l1 von	l1 bis	Art. No.	Ød k12	ØD h7	L	l1 von	l1 bis	Art. No.
0,30	3,00	31	0,3	0,4	1231300030	2,50	12,0	63	3,1	3,8	1231300259
0,40	3,00	31	0,5	0,7	1231300040	3,00	6,00	45	3,9	4,6	1231300300
0,50	2,00	31	0,6	0,9	1231300050	3,00	8,00	50	3,9	4,6	1231300308
0,50	3,00	31	0,6	0,9	1231300053	3,00	10,0	55	3,9	4,6	1231300310
0,50	3,50	35	0,6	0,9	1231300055	3,00	12,0	63	3,9	4,6	1231300312
0,75	2,00	31	1,0	1,3	1231300070	3,00	14,0	69	3,9	4,6	1231300314
0,75	2,50	31	1,0	1,3	1231300072	3,50	8,00	50	4,4	5,1	1231300350
0,75	3,00	31	1,0	1,3	1231300074	3,50	10,0	55	4,4	5,1	1231300351
0,75	3,50	35	1,0	1,3	1231300075	3,50	12,0	63	4,4	5,1	1231300352
0,75	4,00	35	1,0	1,3	1231300076	4,00	8,00	50	5,0	5,9	1231300400
1,00	3,00	31	1,3	1,7	1231300100	4,00	12,0	63	5,0	5,9	1231300412
1,00	3,50	35	1,3	1,7	1231300103	4,00	14,0	69	5,0	5,9	1231300414
1,00	5,00	40	1,3	1,7	1231300105	4,00	16,0	71	5,0	5,9	1231300416
1,00	6,00	45	1,3	1,7	1231300106	5,00	10,0	55	6,3	7,2	1231300500
1,50	4,00	35	2,0	2,6	1231300150	5,00	12,0	63	6,3	7,2	1231300512
1,50	5,00	40	2,0	2,6	1231300155	5,00	14,0	69	6,3	7,2	1231300514
1,50	6,00	45	2,0	2,6	1231300156	5,00	16,0	71	6,3	7,2	1231300516
1,50	8,00	50	2,0	2,6	1231300158	5,00	18,0	77	6,3	7,2	1231300518
2,00	4,00	35	2,5	3,1	1231300204	6,00	12,0	63	8,0	8,9	1231300600
2,00	8,00	50	2,5	3,1	1231300208	6,00	14,0	69	8,0	8,9	1231300614
2,00	10,0	55	2,5	3,1	1231300210	6,00	16,0	71	8,0	8,9	1231300616
2,50	5,00	40	3,1	3,8	1231300250	6,00	18,0	77	8,0	8,9	1231300618
2,50	6,00	45	3,1	3,8	1231300252	6,00	20,0	80	8,0	8,9	1231300620
2,50	7,00	50	3,1	3,8	1231300254	6,00	22,0	100	8,0	8,9	1231300622
2,50	7,50	50	3,1	3,8	1231300256	7,00	20,0	80	9,0	9,9	1231300700
2,50	10,0	55	3,1	3,8	1231300258						

123 140

Zentrierbohrer HSS DIN 333 Form W mit Wulst
HSS Center Drills DIN 333 Form W with Bulge



A

- Zentrierbohrungen mit Wulst
- Hohe Bruchsicherheit
- Zusätzlicher Platz für Schmierstoff
- Form W: Senkwinkel 60°
- Ø0,5 und Ø0,8 nur einseitig
- Oberfläche blank

- Centers acc. DIN 332 with bulge
- Reinforced point
- Better lubrication
- Form W: Chamfering angle 60°
- Ø0,5 and Ø0,8 single end
- Bright finish

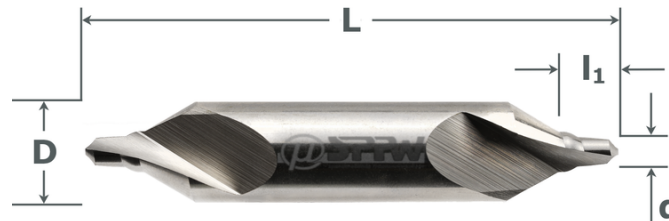

HSS	blank
DIN 333	Form W
60°	

Ød k12	ØD h7	L	l1 von	l1 bis	Art. No.
0,5	3,15	25	0,6	0,9	1231400050
0,8	3,15	25	1	1,3	1231400080
1	3,15	31	1,3	1,7	1231400100
1	4	35	1,3	1,7	1231400104
1,25	3,15	31	1,6	2	1231400125
1,6	4	35	2	2,6	1231400160
2	5	40	2,5	3,1	1231400200
2	6,3	45	2,5	3,1	1231400206

Ød k12	ØD h7	L	l1 von	l1 bis	Art. No.
2,5	6,3	45	3,1	3,8	1231400250
2,5	8	50	3,1	3,8	1231400258
3,15	8	50	3,9	4,6	1231400315
4	10	55	5	5,9	1231400400
5	12,5	63	6,3	7,2	1231400500
6,3	16	71	8	8,9	1231400630
8	20	80	10,1	11,1	1231400800
10	25	100	12,8	13,8	1231401000

123 260

Zentrierbohrer HSS Form A 90°
HSS Center Drills Form A 90°



- Zentrierbohrungen A90
- Hohe Rundlaufgenauigkeit
- Senkwinkel 90°
- Ø0,5 nur einseitig
- Oberfläche blank

- Centers form A90
- High concentricity and precision
- Chamfering angle 90°
- Ø0,5 single end
- Bright finish



HSS	blank
DIN 333	Form A90
90°	

Ød k12	ØD h7	L	l1 von	l1 bis	Art. No.
0,5	3	25	0,6	0,9	1232600050
0,75	3,5	35	1	1,3	1232600075
1	4	35	1,3	1,7	1232600100
1,5	5	40	2	2,6	1232600150
2	6	45	2,5	3,1	1232600200
2,5	8	50	3,1	3,8	1232600250
3	8	50	3,9	4,6	1232600308

Ød k12	ØD h7	L	l1 von	l1 bis	Art. No.
3	10	55	3,9	4,6	1232600310
4	10	55	5	5,9	1232600410
4	12	63	5	5,9	1232600412
5	12	63	6,3	7,2	1232600512
5	14	69	6,3	7,2	1232600514
6	18	77	8	8,9	1232600600
8	25	100	10,1	11,1	1232600800

123 160

Zentrierbohrer HSS DIN 333 Form R

HSS Center Drills DIN 333 Form R



- Radius-Zentrierbohrungen DIN 332 R
- Ringförmige Auflage
- Verbesserter Sitz des Werkstücks
- Hohe Stabilität durch Radius
- Ø0,5 und Ø0,8 nur einseitig
- Oberfläche blank

- Radial centers acc. DIN 332 R
- Stronger tool due to radial transition
- Better alignment of work piece
- Ø0,5 and Ø0,8 single end
- Bright finish

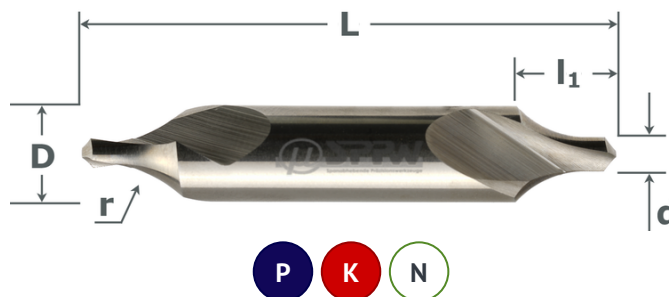

Ød k12	ØD h7	L	l1 von	l1 bis	r Radius	Art. No.
0,5	3,15	25	2,3	2,6	2	1231600050
0,8	3,15	25	2,6	2,9	2,5	1231600080
1	3,15	31	3	3,3	2,9	1231600100
1	4	35	3,3	3,6	3,9	1231600104
1,25	4	35	3,7	4,1	4	1231600124
1,25	3,15	31	3,3	3,6	3,15	1231600125
1,6	4	35	4,2	4,7	4	1231600160
2	5	40	5	5,4	5	1231600200
2	6,3	45	5,6	6	6,3	1231600206
2,5	6,3	45	6,3	6,8	6,3	1231600250
2,5	8	50	7,5	8	8	1231600258

Ød k12	ØD h7	L	l1 von	l1 bis	r Radius	Art. No.
2	6	45	5,4	5,8	5,8	1231600260
3	8	50	8	8,5	8	1231600300
3,15	8	50	8	8,5	8	1231600315
4	10	55	10	10,6	10	1231600400
5	12,5	63	12,5	13,1	12,5	1231600500
6,3	16	71	16	16,6	16	1231600630
6,3	20	80	17,8	19	20	1231600632
8	20	80	20	20,7	20	1231600800
10	25	100	25	25,7	25	1231601000
12,5	31,5	125	31,5	32,3	31,5	1231601250

123 210

Zentrierbohrer HSS DIN 333 Form R Links

HSS Center Drills DIN 333 Form R Left Hand



- Radius-Zentrierbohrungen DIN 332 R
- Linksschneidend
- Höhere Stabilität und verbesserter Sitz
- Ø0,8 nur einseitig
- Oberfläche blank

- Radial centers DIN 332 R
- Left hand cutting - for lathes
- High stability, improved fit
- Ø0,8 single end
- Bright finish

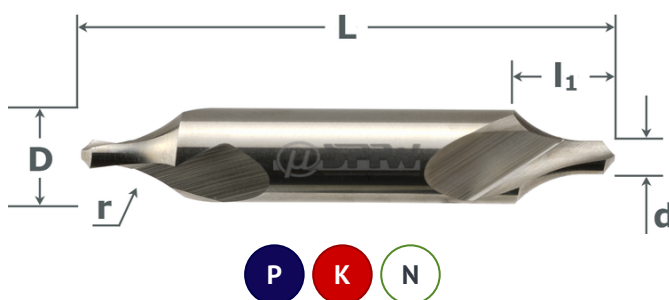

Ød k12	ØD h7	L	l1 von	l1 bis	r Radius	Art. No.
0,8	3,15	25	2,6	2,9	2,5	1232100080
1	3,15	31	3	3,3	2,9	1232100100
1,25	3,15	31	3,3	3,6	3,15	1232100125
1,6	4	35	4,2	4,7	4	1232100160
2	5	40	5	5,4	5	1232100200
2,5	6,3	45	6,3	6,8	6,3	1232100250

Ød k12	ØD h7	L	l1 von	l1 bis	r Radius	Art. No.
3,15	8	50	8	8,5	8	1232100315
4	10	55	10	10,6	10	1232100400
5	12,5	63	12,5	13,1	12,5	1232100512
6,3	16	71	16	16,6	16	1232100630
8	20	80	20	20,7	20	1232100800

123 230

Zentrierbohrer HSS DIN 333 Form B HSS Center Drills DIN 333 Form B



A

- Zentrierbohrungen DIN 332 B
- mit Schutzsenkung 120°
- Hohe Stabilität
- Senkwinkel 60° / 120°
- Oberfläche blank
- Centers DIN 332 B
- With protection chamfer 120°
- High stability
- Form B: Chamfering angles 60°/120°
- Bright finish



HSS	blank
DIN 333	Form B
60° 120°	

Ød k12	ØD h7	L	l1 von	l1 bis	Art. No.	Ød k12	ØD h7	L	l1 von	l1 bis	Art. No.
0,5	3	31	0,6	0,9	1232300050	3,15	11,2	62	3,9	4,6	1232300315
1	4	35	1,3	1,7	1232300100	4	14	69	5	5,9	1232300400
1,25	5	40	1,6	2	1232300125	5	18	77	6,3	7,2	1232300500
1,6	6,3	45	2	2,6	1232300160	6,3	20	80	8	8,9	1232300630
2	8	50	2,5	3,1	1232300200	8	25	100	10,1	11,1	1232300800
2,5	10	55	3,1	3,8	1232300250	10	31,5	125	12,8	13,8	1232301000

123 200

Zentrierbohrer HSS DIN 333 Form B Links HSS Center Drills DIN 333 Form B Left Hand



- DIN 332 B mit Schutzsenkung
- Linksschneidend
- Hohe Stabilität
- Senkwinkel 60° / 120°
- Oberfläche blank
- Centers DIN 332 B
- Left hand cutting - for lathes
- High stability
- Form B: Chamfering angle 60°/120°
- Bright finish



HSS	blank
DIN 333	Form B
60° 120°	LH links

Ød k12	ØD h7	L	l1 von	l1 bis	Art. No.	Ød k12	ØD h7	L	l1 von	l1 bis	Art. No.
1	4	35	1,3	1,7	1232000100	3,15	11,2	62	3,9	4,6	1232000315
1,25	5	40	1,6	2	1232000125	4	14	69	5	5,9	1232000400
1,6	6,3	45	2	2,6	1232000160	5	18	77	6,3	7,2	1232000500
2	8	50	2,5	3,1	1232000200	6,3	20	80	8	8,9	1232000630
2,5	10	55	3,1	3,8	1232000250						

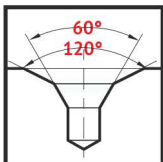
— INFO —

Form B ist durch eine Schutzfase von 120° am Schaftübergang gekennzeichnet. Diese schützt die 60°-Zentrierung vor Beschädigungen, gleichzeitig dient sie als Zentrierhilfe und erleichtert so das automatisierte Spannen von Drehteilen.

Form B is defined by a protective chamfer of 120° at the shank transition. This protects the 60° centering from damage and at the same time serves as a centering aid, thus facilitating the automated clamping of turned parts.

123 340

Zentrierbohrer HSS-E05 DIN 333 Form A

HSS-E05 Center Drills DIN 333 Form A



- Zentrierbohrungen DIN 332 A
- Bessere Hitzebeständigkeit
- Hohe Rundlaufgenauigkeit
- Form A: Senkwinkel 60°
- Ø0,5 und Ø0,8 nur einseitig
- Oberfläche blank

- Centers DIN 332 A
- Improved heat resistance
- High concentricity and precision
- Form A: Chamfering angle 60°
- Ø0,5 and Ø0,8 single end
- Bright finish



Ød k12	ØD h7	L	l1 von	l1 bis	Art. No.	Ød k12	ØD h7	L	l1 von	l1 bis	Art. No.
0,5	3,15	25	0,6	0,9	1233400050	2,5	6,3	45	3,1	3,8	1233400250
0,75	3,5	35	1	1,3	1233400075	2,5	8	50	3,1	3,8	1233400258
0,8	3,15	25	1	1,3	1233400080	3	8	50	3,9	4,6	1233400308
1	3,15	31	1,3	1,7	1233400100	3	10	55	3,9	4,6	1233400310
1	4	35	1,3	1,7	1233400104	3,15	8	50	3,9	4,6	1233400315
1,25	3,15	31	1,6	2	1233400125	4	10	55	5	5,9	1233400400
1,5	5	40	2	2,6	1233400150	4	12	63	5	5,9	1233400412
1,6	4	35	2	2,6	1233400160	5	12,5	63	6,3	7,2	1233400500
2	5	40	2,5	3,1	1233400200	5	12	63	6,3	7,2	1233400512
2	6	45	2,5	3,1	1233400206	5	14	69	6,3	7,2	1233400514

123 350

Zentrierbohrer HSS-E05+A.Cut DIN 333 Form A

HSS-E05 Center Drills+A.Cut DIN 333 Form A



- Zentrierbohrungen DIN 332 A
- Bessere Hitzebeständigkeit
- Senkwinkel 60°
- Ab Ø 6,3 aus HSS
- Ø0,5 und Ø0,8 nur einseitig
- Oberfläche A.Cut beschichtet

- Centers DIN 332 A
- Improved heat resistance
- Form A: Chamfering angle 60°
- From Ø6,3 in HSS
- Ø0,5 and Ø0,8 single end
- With A.Cut coating

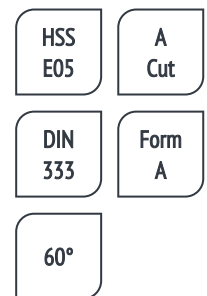
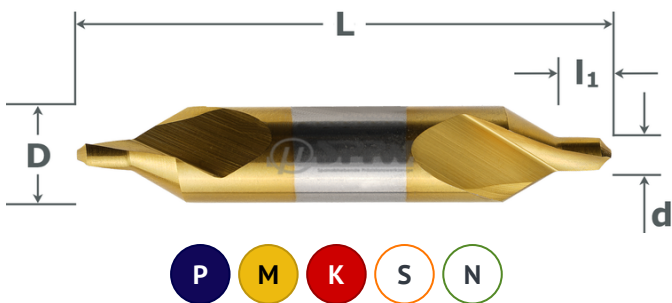

Ød k12	ØD h7	L	l1 von	l1 bis	Art. No.	Ød k12	ØD h7	L	l1 von	l1 bis	Art. No.
0,5	3,15	25	0,6	0,9	1233500050	2,5	8	50	3,1	3,8	1233500258
0,75	3,5	35	1	1,3	1233500075	3	8	50	3,9	4,6	1233500300
0,8	3,15	25	1	1,3	1233500080	3	10	55	3,9	4,6	1233500310
1	3,15	31	1,3	1,7	1233500100	3,15	8	50	3,9	4,6	1233500315
1	4	35	1,3	1,7	1233500104	4	10	55	5	5,9	1233500400
1,25	3,15	31	1,6	2	1233500125	4	12	63	5	5,9	1233500412
1,5	5	40	2	2,6	1233500150	5	12,5	63	6,3	7,2	1233500500
1,6	4	35	2	2,6	1233500160	5	12	63	6,3	7,2	1233500512
2	5	40	2,5	3,1	1233500200	5	14	69	6,3	7,2	1233500514
2	6	45	2,5	3,1	1233500206	6,3	16	71	8	8,9	1233500630
2,5	6,3	45	3,1	3,8	1233500250	8	20	80	10,1	11,1	1233500800

123 490

Zentrierbohrer HSS-E05+X.Cut DIN 333 Form A
HSS-E05 Center Drills+X.Cut DIN 333 Form A



A

- Zentrierbohrungen DIN 332 A
- Bessere Hitzebeständigkeit
- Senkwinkel 60°
- Oberfläche X.Cut beschichtet
- Centers DIN 332 A
- Improved heat resistance
- Form A: Chamfering angle 60°
- With X.Cut coating



HSS E05	X Cut
DIN 333	Form A
60°	

Ød k12	ØD h7	L	l1 von	l1 bis	Art. No.	Ød k12	ØD h7	L	l1 von	l1 bis	Art. No.
1	3,15	31	1,3	1,7	1234900100	2,5	8	50	3,1	3,8	1234900258
1,25	3,15	31	1,6	2	1234900125	3,15	8	50	3,9	4,6	1234900315
1,6	4	35	2	2,6	1234900160	4	10	55	5	5,9	1234900400
2	5	40	2,5	3,1	1234900200	5	12,5	63	6,3	7,2	1234900500
2,5	6,3	45	3,1	3,8	1234900250						

123 480

Zentrierbohrer HSS-E PM+X.Cut DIN 333 Form A
HSS-E Powdermetal Center Drills +X.Cut DIN 333 Form A



- HSS-E Pulvermetall
- Höhere Härte und Zähigkeit
- Zentrierbohrungen DIN 332 A
- Senkwinkel 60°
- Oberfläche X5.Cut beschichtet
- HSS-E powder metal
- Improved hardness and resistance
- Centers DIN 332 A
- Chamfering angle 60°
- With X5.Cut coating

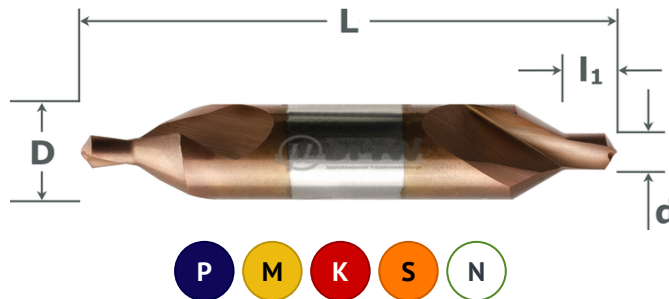

HSS PM	X Cut
DIN 333	Form A
60°	

Ød k12	ØD h7	L	l1 von	l1 bis	Art. No.	Ød k12	ØD h7	L	l1 von	l1 bis	Art. No.
1,00	3,15	31	1,3	1,7	1234800100	2,50	6,30	45	3,1	3,8	1234800250
1,25	3,15	31	1,6	2	1234800125	3,15	8,00	50	3,9	4,6	1234800315
1,60	4,00	35	2	2,6	1234800160	4,00	10,0	55	5	5,9	1234800400
2,00	5,00	40	2,5	3,1	1234800200	5,00	12,5	63	6,3	7,2	1234800500

— INFO —



- Pulvermetall mit hohem Kobalt Anteil
- 67-68 HRC Härte für besten Verschleisschutz
- Hohe Zähigkeit und Warmhärtebeständigkeit
- X5.Cut Beschichtung mit 3500 HV für zusätzlichen Schutz

- Powder metal with high cobalt content
- 68 HRC hardness for best wear protection
- High toughness and hot hardness
- X5.Cut coating with mit 3500 HV for additional protection



- Lange Ausführung
- Zentrierungen mit Zugangsproblemen
- Hohe Rundlaufgenauigkeit
- Senkwinkel 60°
- Oberfläche blank

- Long version
- Operations with access problems
- High concentricity and precision
- Form A: Chamfering angle 60°
- Bright finish

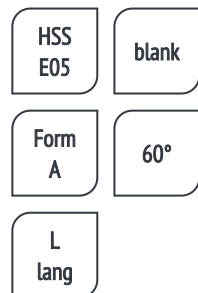

123520 - OAL:60/80

Ød k12	ØD h7	L	l1 von	l1 bis	Art. No.
0,75	3,5	60	1	1,3	1235200075
1	4	60	1,3	1,7	1235200100
1,5	5	60	2	2,6	1235200150

Ød k12	ØD h7	L	l1 von	l1 bis	Art. No.
2	6	80	2,5	3,1	1235200200
2,5	8	80	3,1	3,8	1235200250
3	8	80	3,9	4,6	1235200300

123530 - OAL:100

Ød k12	ØD h7	L	l1 von	l1 bis	Art. No.
1	4	100	1,3	1,7	1235300100
1,5	5	100	2	2,6	1235300150
2	6	100	2,5	3,1	1235300200
2,5	8	100	3,1	3,8	1235300250
3	8	100	3,9	4,6	1235300308

Ød k12	ØD h7	L	l1 von	l1 bis	Art. No.
3	10	100	3,9	4,6	1235300310
4	10	100	5	5,9	1235300400
4	12	100	5	5,9	1235300412
5	12	100	6,3	7,2	1235300512

123540 - OAL:120

Ød k12	ØD h7	L	l1 von	l1 bis	Art. No.
0,75	3,5	120	1	1,3	1235400075
1	4	120	1,3	1,7	1235400100
1,5	5	120	2	2,6	1235400150
1,6	5	120	2	2,6	1235400160
2	6	120	2,5	3,1	1235400200
2,5	8	120	3,1	3,8	1235400250

Ød k12	ØD h7	L	l1 von	l1 bis	Art. No.
3	8	120	3,9	4,6	1235400308
3,15	10	120	3,9	4,6	1235400310
3	10	120	3,9	4,6	1235400311
4	10	120	5	5,9	1235400400
4	12	120	5	5,9	1235400412
5	14	120	6,3	7,2	1235400500

123510 - OAL:150

Ød k12	ØD h7	L	l1 von	l1 bis	Art. No.
1	4	150	1,3	1,7	1235100100
1,5	5	150	2	2,6	1235100150
2	6	150	2,5	3,1	1235100200
2,5	8	150	3,1	3,8	1235100250
3	8	150	3,9	4,6	1235100308

Ød k12	ØD h7	L	l1 von	l1 bis	Art. No.
3	10	150	3,9	4,6	1235100310
4	10	150	5	5,9	1235100410
4	12	150	5	5,9	1235100412
6,3	16	150	8	8,9	1235100630

123550 - OAL:200

Ød k12	ØD h7	L	l1 von	l1 bis	Art. No.
2	5	200	2,5	3,1	1235500200
2,5	6,3	200	3,1	3,8	1235500250

Ød k12	ØD h7	L	l1 von	l1 bis	Art. No.
3,15	8	200	3,9	4,6	1235500315
4	10	200	5	5,9	1235500400

123 290

Zentrierbohrer HSS-E05 DIN 333 Form A mit Fläche
HSS-E05 Center Drills DIN 333 Form A with Flat



A

- Mit durchgehender Spannfläche
- Kombiniertes Planen und Zentrieren
- Zentrierbohrungen DIN 332 A
- Senkwinkel 60°
- Oberfläche blank
- With full-length clamping flat
- Combined centering/facing operations
- Centers DIN 332 A
- Form A: Chamfering angle 60°
- Bright finish



HSS E05	blank
DIN 333	Form A
60°	FLAT

Ød k12	ØD h7	L	l1 von	l1 bis	Art. No.
1,6	4	35	2	2,6	1232900160
2	5	40	2,5	3,1	1232900200
2,5	6,3	45	3,1	3,8	1232900250
3,15	8	50	3,9	4,6	1232900315
4	10	55	5	5,9	1232900400

Ød k12	ØD h7	L	l1 von	l1 bis	Art. No.
5	12,5	63	6,3	7,2	1232900500
6,3	16	71	8	8,9	1232900630
8	20	80	10,1	11,1	1232900800
10	25	100	12,8	13,8	1232901000

123 296

Zentrierbohrer HSS-E05+A.Cut DIN 333 Form A mit Fläche
HSS-E05 Center Drills+A.Cut DIN 333 Form A mit Fläche



- Mit durchgehender Spannfläche
- Kombiniertes Planen und Zentrieren
- Zentrierbohrungen DIN 332 A
- Senkwinkel 60°
- Oberfläche A.Cut beschichtet
- With full-length clamping flat
- Combined centering/facing operations
- Centers DIN 332 A
- Form A: Chamfering angle 60°
- With A.Cut coating

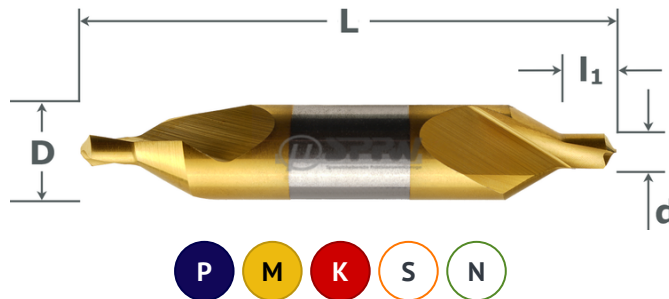

HSS E05	A Cut
DIN 333	Form A
60°	FLAT

Ød k12	ØD h7	L	l1 von	l1 bis	Art. No.
1,6	4	35	2	2,6	1232960160
2	5	40	2,5	3,1	1232960200
2,5	6,3	45	3,1	3,8	1232960250
3,15	8	50	3,9	4,6	1232960315

Ød k12	ØD h7	L	l1 von	l1 bis	Art. No.
4	10	55	5	5,9	1232960400
5	12,5	63	6,3	7,2	1232960500
6,3	16	71	8	8,9	1232960630

— INFO —



- Senkwinkel 60° mit geraden Laufflächen
- Spannfläche für Kombiwerkzeuge zum Zentrieren, Planen und Fasen
- 60° Chamfering angle with straight running faces
- with flat for combined centering, chamfering and facing tools

123 280

Zentrierbohrer HSS-E05 DIN 333 Form R mit Fläche

HSS-E05 Center Drills DIN 333 Form R with Flat



- Mit durchgehender Spannfläche
- Kombiniertes Planen und Zentrieren
- Radius-Zentrierbohrungen DIN 332 R
- Oberfläche blank
- With full-length clamping flat
- Combined centering/facing operations
- For radial centers DIN 332 R
- Bright finish

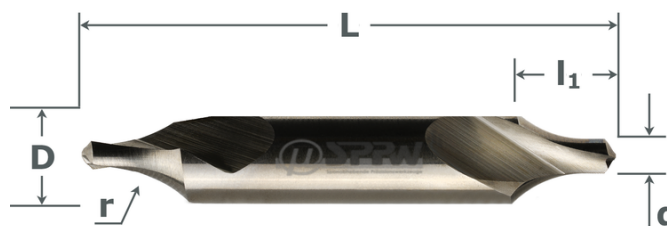

HSS E05	blank
DIN 333	Form R
Radius	FLAT

Ød k12	ØD h7	L	l1 von	l1 bis	r Radius	Art. No.
1,6	4	35	4,2	4,7	4	1232800160
2	5	40	5	5,4	5	1232800200
2,5	6,3	45	6,3	6,8	6,3	1232800250
3,15	8	50	8	8,5	8	1232800315

Ød k12	ØD h7	L	l1 von	l1 bis	r Radius	Art. No.
4	10	55	10	10,6	10	1232800400
5	12,5	63	12,5	13,1	12,5	1232800500
6,3	16	71	16	16,6	16	1232800630
8	20	80	20	20,7	20	1232800800

123 286

Zentrierbohrer HSS-E05+A.Cut DIN 333 Form R mit Fläche

HSS-E05 Center Drills+A.Cut DIN 333 Form R with Flat



- Mit durchgehender Spannfläche
- Kombiniertes Planen und Zentrieren
- Radius-Zentrierbohrungen DIN 332 R
- Oberfläche A.Cut beschichtet
- With full-length clamping flat
- Combined centering/facing operations
- For radial centers DIN 332 R
- With A.Cut coating

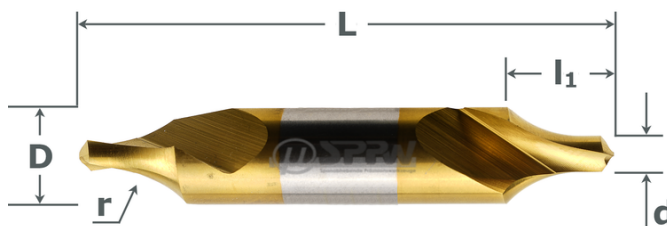

HSS E05	A Cut
DIN 333	Form R
Radius	FLAT

Ød k12	ØD h7	L	l1 von	l1 bis	r Radius	Art. No.
1,6	4	35	4,2	4,7	4	1232860160
2	5	40	5	5,4	5	1232860200
2,5	6,3	45	6,3	6,8	6,3	1232860250
3,15	8	50	8	8,5	8	1232860315

Ød k12	ØD h7	L	l1 von	l1 bis	r Radius	Art. No.
4	10	55	10	10,6	10	1232860400
5	12,5	63	12,5	13,1	12,5	1232860500
6,3	16	71	16	16,6	16	1232860630

— INFO —

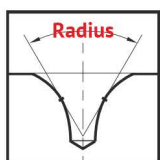

- Radius: besonders Stabil, da radialer Übergang in den Schaft
- Spannfläche für Kombiwerkzeuge zum Zentrieren, Planen und Fasen
- Radius: extremely rigid due to gradual transition into the shank
- with flat for combined centering, chamfering and facing tools

123 300

Zentrierbohrer HSS-E05 DIN 333 Form B mit Fläche

HSS-E05 Center Drills DIN 333 Form B with Flat



A

- Mit durchgehender Spannfläche
- Kombiniertes Planen und Zentrieren
- DIN 332 B mit Schutzsenkung
- Senkwinkel 60° / 120°
- Oberfläche blank
- With full-length clamping flat
- Combined centering/facing operations
- Centers DIN 332 B
- Form B: Chamfering angle 60°/120°
- Bright finish

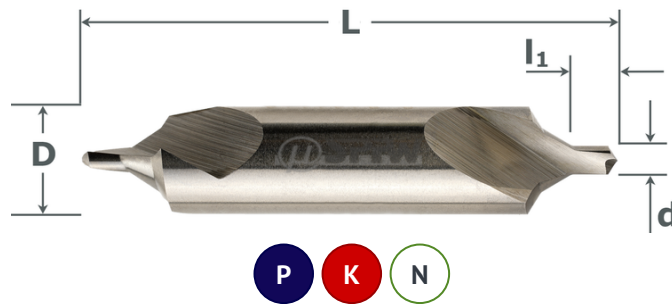

HSS E05	blank
DIN 333	Form B
60° / 120°	FLAT

Ød k12	ØD h7	L	l1 von	l1 bis	Art. No.	Ød k12	ØD h7	L	l1 von	l1 bis	Art. No.
1,6	6,3	45	2	2,6	1233000160	5	18	77	6,3	7,2	1233000500
2	8	50	2,5	3,1	1233000200	6,3	20	80	8	8,9	1233000630
2,5	10	55	3,1	3,8	1233000250	8	25	100	10,1	11,1	1233000800
3,15	11,2	63	3,9	4,6	1233000315	10	31,5	125	12,8	13,8	1233001000
4	14	69	5	5,9	1233000400						

123 306

Zentrierbohrer HSS-E05+A.Cut DIN 333 Form B mit Fläche

HSS-E05 Center Drills+A.Cut DIN 333 Form B with Flat



- Mit durchgehender Spannfläche
- Kombiniertes Planen und Zentrieren
- DIN 332 B mit Schutzsenkung
- Senkwinkel 60° / 120°
- Oberfläche A.Cut beschichtet
- With full-length clamping flat
- Combined centering/facing operations
- Centers DIN 332 B
- Form B: Chamfering angle 60°/120°
- With A.Cut coating

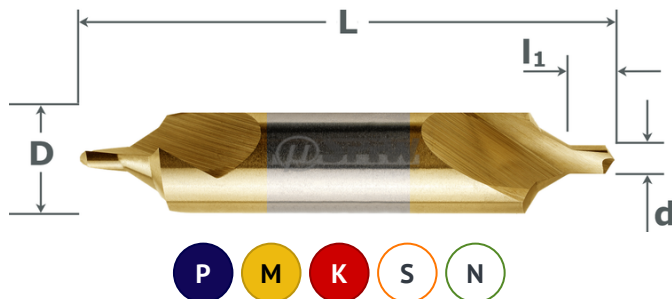

HSS E05	A Cut
DIN 333	Form B
60° / 120°	FLAT

Ød k12	ØD h7	L	l1 von	l1 bis	Art. No.	Ød k12	ØD h7	L	l1 von	l1 bis	Art. No.
1,6	6,3	45	2	2,6	1233060160	4	14	69	5	5,9	1233060400
2	8	50	2,5	3,1	1233060200	5	18	77	6,3	7,2	1233060500
2,5	10	55	3,1	3,8	1233060250	6,3	20	80	8	8,9	1233060630
3,15	11,2	63	3,9	4,6	1233060315						

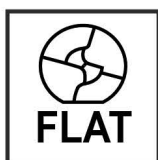
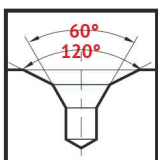
INFO

- Besonders stabil: Senkwinkel 60° mit Schutzfase 120°
- Spannfläche für Kombiwerkzeuge zum Zentrieren, Planen und Fasen
- Extremely rigid: 60° chamfering angle with 120° protective chamfer
- with flat for combined centering, chamfering and facing tools

123 420

Kernloch-Stufenzentrierbohrer HSS-E05 Form D-FL HSS-E05 Step Center Drills for Threaded Holes Form D-FL



- Formbohrung nach DIN 332-2 D
- Kernloch, Fase und Zentrierung
- Mit Fläche und Kühlnuten
- Oberfläche blank

- Profile drilling acc. DIN 332-2 D
- tap hole, chamfer and center
- With flat and coolant grooves
- Bright finish

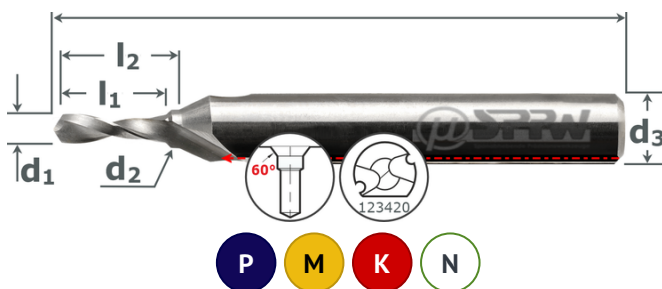

HSS E05	blank
DIN 332-2	Form D
60° 90°	FLAT

60° - Fläche und Kühlnuten | Flat and Coolant

M	Ød1 -0,05	Ød2 ±0,05	Ød3 h7	L	l1	l2	FL Fläche	Art. No.
4	3,3	4,3	8	63	11	12,6	6,75	1234200400
5	4,2	5,3	10	67	13	15,1	8,45	1234200500
6	5	6,4	12,5	71	16	18,9	10,45	1234200600
8	6,8	8,4	14	88	19	23	12,5	1234200800
10	8,5	10,5	16	90	23	27,7	14,85	1234201000
12	10,2	13	20	105	28	34,5	18,45	1234201200
16	14	17	25	132	33	41,3	23,4	1234201600
20	17,5	21	31,5	145	38	48,3	29,35	1234202000
24	21	25	40	160	45	57	36,5	1234202400

123 620

Kernloch-Stufenzentrierbohrer HSS-E05 Form D HSS-E05 Step Center Drills for Threaded Holes Form D



- Formbohrung nach DIN 332-2 D
- Kernloch, Fase und Zentrierung
- Ohne Fläche und Kühlnuten
- Oberfläche blank

- Profile drilling acc. DIN 332-2 D
- tap hole, chamfer and center
- Without flat and coolant grooves
- Bright finish

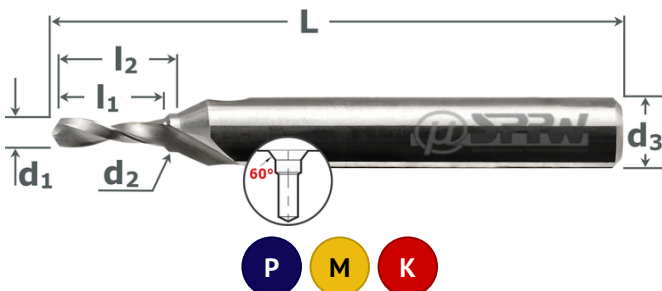

HSS E05	blank
DIN 332-2	Form D
60° 90°	ZYL

60° - Zylinderschaft | Cylindrical Shank

M	Ød1 -0,05	Ød2 ±0,05	Ød3 h7	L	l1	l2	Art. No.
3	2,5	3,2	6	55	8	9	1236200300
4	3,3	4,3	8	63	11	12,6	1236200400
5	4,2	5,3	10	67	13	15,1	1236200500
6	5	6,4	12,5	71	16	18,9	1236200600
8	6,8	8,4	14	88	19	23	1236200800
10	8,5	10,5	16	90	23	27,7	1236201000
12	10,2	13	20	105	28	34,5	1236201200

123 650

Kernloch-Stufenzentrierbohrer HSS-E05 Form DR-FL HSS-E05 Step Center Drills for Threaded Holes Form DR-FL



A

- Formbohrung nach DIN 332-2 DR
- Zentrierung DIN 332-2 DR (Radius)
- Kernloch, Fase und Zentrierung
- Mit Fläche und Kühlnuten
- Oberfläche blank
- Profile drilling acc. DIN 332-2 DR
- For radial centers
- tap hole, chamfer and center
- With flat and coolant grooves
- Bright finish

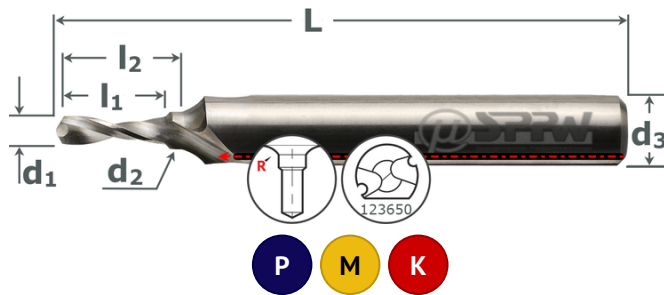

HSS E05	blank
DIN 332-2	Form DR
Radius 90°	FLAT

Radius - Fläche und Kühlnuten | Flat and Coolant

M	Ød1 -0,05	Ød2 ±0,05	Ød3 h7	L	l1	l2	FL Fläche	R Radius	Art. No.
4	3,3	4,3	8	63	11	12,6	6,75	4	1236500400
5	4,2	5,3	10	67	13	15,1	8,45	6	1236500500
6	5	6,4	12,5	71	16	18,9	10,45	8	1236500600
8	6,8	8,4	14	88	19	23	12,5	10	1236500800
10	8,5	10,5	16	90	23	27,7	14,85	14	1236501000
12	10,2	13	20	105	28	34,5	18,45	16	1236501200
16	14	17	25	132	33	41,3	23,4	25	1236501600
20	17,5	21	31,5	145	38	48,3	29,35	31,5	1236502000
24	21	25	40	160	45	57	36,5	40	1236502400

123 630

Kernloch-Stufenzentrierbohrer HSS-E05 Form DR HSS-E05 Step Center Drills for Threaded Holes Form DR



- Formbohrung nach DIN 332-2 DR
- Zentrierung DIN 332-2 DR (Radius)
- Kernloch, Fase und Zentrierung
- Ohne Fläche und Kühlnuten
- Oberfläche blank
- Profile drilling acc. DIN 332-2 DR
- For radial centers
- tap hole, chamfer and center
- Without flat and coolant grooves
- Bright finish

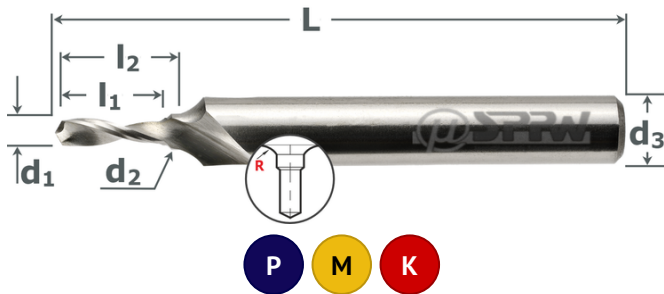

HSS E05	blank
DIN 332-2	Form DR
Radius 90°	ZYL

Radius - Zylinderschaft | Cylindrical Shank

M	Ød1 -0,05	Ød2 ±0,05	Ød3 h7	L	l1	l2	R Radius	Art. No.
4	3,3	4,3	8	63	11	12,6	4	1236300400
5	4,2	5,3	10	67	13	15,1	6	1236300500
6	5	6,4	12,5	71	16	18,9	8	1236300600
8	6,8	8,4	14	88	19	23	10	1236300800
10	8,5	10,5	16	90	23	27,7	14	1236301000
12	10,2	13	20	105	28	34,5	16	1236301200

123 670

Kernloch-Stufenzentrierbohrer HSS-E05 Form DS-FL HSS-E05 Step Center Drills for Threaded Holes Form DS-FL



- Formbohrung nach DIN 332-2 DS
- Mit Schutzsenkung (60°/120°)
- Kernloch, Fase und Zentrierung
- Mit Fläche und Kühlnuten
- Oberfläche blank

- Profile drilling acc. DIN 332-2 DS
- Centers with protection chamfer
- Tap hole, chamfer and center
- With flat and coolant grooves
- Bright finish

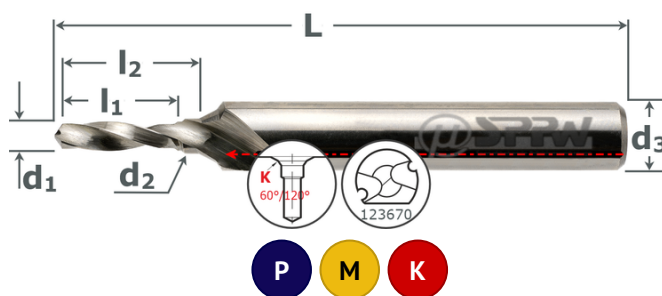

HSS E05	blank
DIN 332-2	Form DS
60/120 90°	FLAT

60°/120° - Fläche und Kühlnuten | Flat and Coolant

M	Ød1 -0,05	Ød2 ±0,05	Ød3 h7	L	l1	l2	FL Fläche	K js13	Art. No.
4	3,3	4,3	8	63	11	12,6	6,75	6,4	1236700400
5	4,2	5,3	10	67	13	15,1	8,45	7,8	1236700500
6	5	6,4	12,5	71	16	18,9	10,45	9,1	1236700600
8	6,8	8,4	14	88	19	23	12,5	11,8	1236700800
10	8,5	10,5	18	90	23	27,7	14,85	14,2	1236701000
12	10,2	13	20	105	28	34,5	18,45	17,4	1236701200
16	14	17	26	132	33	41,3	23,4	21,9	1236701600

123 660

Kernloch-Stufenzentrierbohrer HSS-E05 Form DS HSS-E05 Step Center Drills for Threaded Holes Form DS



- Formbohrung nach DIN 332-2 DS
- Mit Schutzsenkung(60°/120°)
- Kernloch, Fase und Zentrierung
- Oberfläche blank

- Profile drilling acc. DIN 332-2 DS
- Centers with protection chamfer
- tap hole, chamfer and center
- Bright finish

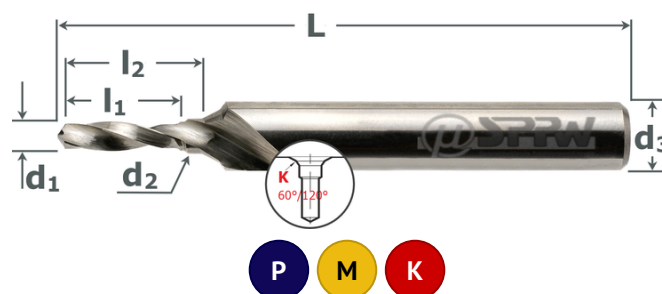

HSS E05	blank
DIN 332-2	Form DS
60/120 90°	ZYL

60°/120° - Zylinderschaft | Cylindrical Shank

M	Ød1 -0,05	Ød2 ±0,05	Ød3 h7	L	l1	l2	K js13	Art. No.
4	3,3	4,3	8	63	11	12,6	6,4	1236600400
5	4,2	5,3	10	67	13	15,1	7,8	1236600500
6	5	6,4	12,5	71	16	18,9	9,1	1236600600
8	6,8	8,4	14	88	19	23	11,8	1236600800
10	8,5	10,5	18	90	23	27,7	14,2	1236601000
12	10,2	13	20	105	28	34,5	17,4	1236601200



Spanabhebende Präzisionswerkzeuge

[DE] **Anbohren**
[EN] **Spotting**



passion for precision
[Leidenschaft für Präzision]



Micro-NC-Anbohrer VHM

Carbide Micro NC Spotting Drills

Art.No./Page

		VHM	X Cut	90°	DIN 6535HA	Micro	623 200 Seite B 1
--	--	-----	-------	-----	------------	-------	-----------------------------

NC-Anbohrer VHM

Carbide NC Spotting Drills

Art.No./Page

		VHM	blank	ISO 10898	60°	DIN 6535HA	623 480 Seite B 1
		VHM	blank	ISO 10898	90°	DIN 6535HA DIN 6535HB	623 490 Seite B 2
		VHM	blank	ISO 10898	90°	DIN 6535HB	623 491 Seite B 2
		VHM	blank	ISO 10898	90°	DIN 6535HA L lang	623 390 Seite B 2
		VHM	X Cut	ISO 10898	90°	DIN 6535HA DIN 6535HB	623 497 Seite B 3
		VHM	X Cut	ISO 10898	90°	DIN 6535HB	623 492 Seite B 3
		VHM	X Cut	ISO 10898	90°	DIN 6535HA L lang	623 397 Seite B 3
		VHM	blank	ISO 10898	120°	DIN 6535HA DIN 6535HB	623 500 Seite B 4
		VHM	blank	ISO 10898	120°	DIN 6535HB	623 501 Seite B 4
		VHM	blank	ISO 10898	120°	DIN 6535HA L lang	623 580 Seite B 4
		VHM	X Cut	ISO 10898	120°	DIN 6535HA DIN 6535HB	623 507 Seite B 5
		VHM	X Cut	ISO 10898	120°	DIN 6535HB	623 502 Seite B 5
		VHM	X Cut	ISO 10898	120°	DIN 6535HA L lang	623 587 Seite B 5
		VHM	blank	ISO 10898	142°	DIN 6535HA DIN 6535HB	623 511 Seite B 6
		VHM	X Cut	ISO 10898	142°	DIN 6535HA DIN 6535HB	623 512 Seite B 6

NC-Anbohrer HSS-E05

HSS-E05 NC Spotting Drills

Art.No./Page

		HSS E05	blank	ISO 10898	60°	DIN 1835A	123 640 Seite B 7
		HSS E05	blank	ISO 10898	90°	DIN 1835A DIN 1835B	123 370 Seite B 8

●	●	●			○			HSS E05	blank	ISO 10898	90°	DIN 1835B		123 371 Seite B 8
●	●	●			○			HSS E05	blank	ISO 10898	90°	DIN 1835A	L lang	123 390 Seite B 8
●	●	●			○			HSS E05	blank	ISO 10898	90°	DIN 1835A	LH links	123 310 Seite B 9
●	●	●			○			HSS E05	blank	ISO 10898	90°	MK MTS		123 440 Seite B 9
●	●							HSS E05	A Cut	ISO 10898	90°	DIN 1835A	DIN 1835B	123 450 Seite B 10
●	●							HSS E05	A Cut	ISO 10898	90°	DIN 1835B		123 451 Seite B 10
●	●	●			○			HSS E05	X Cut	ISO 10898	90°	DIN 1835A	DIN 1835B	123 590 Seite B 11
●	●	●			○			HSS E05	X Cut	ISO 10898	90°	DIN 6535HB		123 591 Seite B 11
●	●	●			○			HSS E05	X Cut	ISO 10898	90°	DIN 1835A	L lang	123 397 Seite B 11
●	●	●			○			HSS E05	blank	ISO 10898	120°	DIN 1835A	DIN 1835B	123 380 Seite B 12
●	●	●			○			HSS E05	blank	ISO 10898	120°	DIN 1835B		123 381 Seite B 12
●	●	●			○			HSS E05	blank	ISO 10898	120°	DIN 1835A	L lang	123 580 Seite B 12
●	●	●			○			HSS E05	blank	ISO 10898	120°	DIN 1835A	LH links	123 320 Seite B 13
●	●							HSS E05	blank	ISO 10898	120°	MK MTS		123 470 Seite B 13
●	●							HSS E05	A Cut	ISO 10898	120°	DIN 1835A	DIN 1835B	123 460 Seite B 14
●	●							HSS E05	A Cut	ISO 10898	120°	DIN 1835B		123 461 Seite B 14
●	●	●			○			HSS E05	X Cut	ISO 10898	120°	DIN 1835A	DIN 1835B	123 600 Seite B 15
●	●	●			○			HSS E05	X Cut	ISO 10898	120°	DIN 1835B		123 601 Seite B 15
●	●	●			○			HSS E05	X Cut	ISO 10898	120°	DIN 1835A	L lang	123 587 Seite B 15
●	●	●			○			HSS E05	blank	ISO 10898	142°	DIN 1835A		123 384 Seite B 16
●	●	●			○			HSS E05	X Cut	ISO 10898	142°	DIN 1835A		123 604 Seite B 16

DuoMag Doppelseitige Anbohrer

DuoMag Double Sided Spotting Drills

Art.No./Page

		HSS E05	X Cut	60°	2 ENDS		124 607 Seite B 17
		HSS E05	X Cut	60°	2 ENDS	OAL 100	124 617 Seite B 17
		HSS E05	X Cut	60°	2 ENDS	OAL 150	124 627 Seite B 17
		HSS E05	X Cut	90°	2 ENDS		124 907 Seite B 18
		HSS E05	X Cut	90°	2 ENDS	OAL 100	124 917 Seite B 18
		HSS E05	X Cut	90°	2 ENDS	OAL 150	124 927 Seite B 18
		VHM	X Cut	90° 118°	2 ENDS		624 907 Seite B 19

— INFO —

NC-Anbohrer Spitzenwinkel | Spotting Drill Point Angles

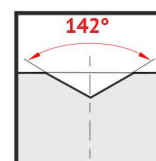
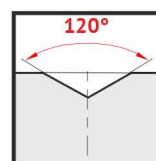
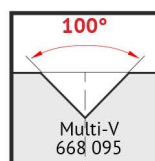
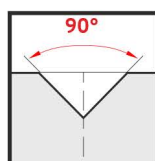
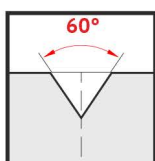

- Abweichende Winkel und Ausführungen auf Anfrage
- Different angles and configurations on request

623 200**Micro-NC-Anbohrer VHM+X.Cut 90°
Carbide Micro NC Spotting Drills+X.Cut 90°**

- Formgenauer Präzisionsanschliff
- Optimiertes Eindringverhalten
- Hohe Rundlaufgenauigkeit
- Verstärkter Schaft Ø3 h6
- Senkwinkel 90°
- Oberfläche X.Cut beschichtet

- High precision point geometry
- Easy penetration and high accuracy
- High concentricity
- Reinforced shank Ø3 h6
- Point angle 90°
- With X.Cut coating



VHM	X Cut
90°	DIN 6535HA
Micro	

B

ØD	Ød2	L	l1	Art. No.
0.01	h6			
0,3	3	39	0,9	6232000030
0,4	3	39	1,2	6232000040
0,5	3	39	1,5	6232000050
0,6	3	39	1,8	6232000060
0,7	3	39	2,1	6232000070
0,8	3	39	2,4	6232000080

ØD	Ød2	L	l1	Art. No.
0.01	h6			
0,9	3	39	2,7	6232000090
1	3	39	3	6232000100
1,2	3	39	3,6	6232000120
1,5	3	39	4,5	6232000150
2	3	39	6	6232000200
2,5	3	39	7,5	6232000250

623 480**NC-Anbohrer VHM 60°
Carbide NC Spotting Drills 60°**

- Formgenauer Präzisionsanschliff
- Optimiertes Eindringverhalten
- Hohe Rundlaufgenauigkeit
- Glatter Zylinderschaft mit Toleranz h6
- Senkwinkel 60°
- Oberfläche blank

- High precision point geometry
- Easy penetration and high accuracy
- High concentricity
- Straight shank in tolerance h6
- Point angle 60°
- Bright finish

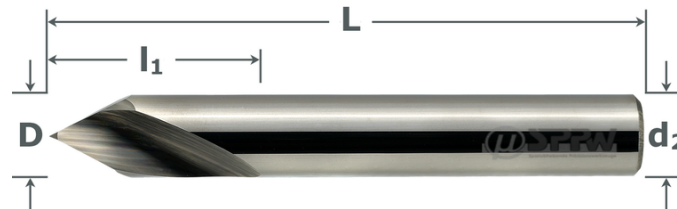

VHM	blank
ISO 10898	60°
DIN 6535HA	

ØD	Ød2	L	l1	Art. No.
h6	h6			
2	2	40	8	6234800200
3	3	45	10	6234800300
4	4	50	12	6234800400
5	5	50	15	6234800500
6	6	50	18	6234800600

ØD	Ød2	L	l1	Art. No.
h6	h6			
8	8	60	23	6234800800
10	10	70	24	6234801000
12	12	70	24	6234801200
16	16	80	26	6234801600

623 490**NC-Anbohrer VHM 90°
Carbide NC Spotting Drills 90°****B**

- Formgenauer Präzisionsanschliff
- Optimiertes Eindringverhalten
- Hohe Rundlaufgenauigkeit
- Glatter Zylinderschaft mit Toleranz h6
- Senkwinkel 90°
- Oberfläche blank

- High precision point geometry
- Easy penetration and high accuracy
- High concentricity
- Straight shank in tolerance h6
- Point angle 90°
- Bright finish

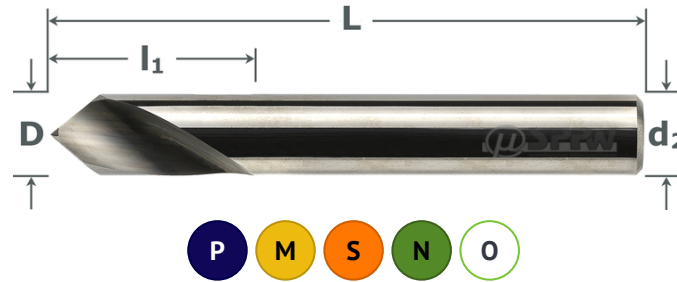

VHM	blank
ISO 10898	90°
DIN 6535HA	DIN 6535HB

ØD h6	Ød2 h6	L	l1	Art. No.	ØD h6	Ød2 h6	L	l1	Art. No.
2	2	40	8	6234900200	8	8	60	23	6234900800
3	3	45	10	6234900300	10	10	70	24	6234901000
4	4	50	12	6234900400	12	12	70	24	6234901200
5	5	50	15	6234900500	16	16	80	26	6234901600
6	6	50	18	6234900600	20	20	100	35	6234902000

623491 - Schaft DIN 6535 HB | Weldon Shank

ØD h6	Ød2 h6	L	l1	Schaft	Art. No.	ØD h6	Ød2 h6	L	l1	Schaft	Art. No.
6	6	50	18	HB	6234910600	12	12	70	24	HB	6234911200
8	8	60	23	HB	6234910800	16	16	80	26	HB	6234911600
10	10	70	24	HB	6234911000	20	20	100	35	HB	6234912000

623 390**NC-Anbohrer VHM 90° Lang
Carbide NC Spotting Drills 90° Long Series**

- Formgenauer Präzisionsanschliff
- Lange Version für Zugangsprobleme
- Hohe Rundlauf- und Formgenauigkeit
- Glatter Zylinderschaft Toleranz h6
- Senkwinkel 90°
- Oberfläche blank

- High precision point geometry
- Long version for access problems
- High concentricity
- Straight shank in tolerance h6
- Point angle 90°
- Bright finish



VHM	blank
ISO 10898	90°
DIN 6535HA	L lang

ØD h6	Ød2 h6	L	l1	Art. No.	ØD h6	Ød2 h6	L	l1	Art. No.
4	4	100	12	6233900400	10	10	170	25	6233901000
5	5	120	15	6233900500	12	12	170	30	6233901200
6	6	140	20	6233900600	16	16	200	35	6233901600
8	8	140	25	6233900800	20	20	200	40	6233902000

623 497

NC-Anbohrer VHM+X.Cut 90°
Carbide NC Spotting Drills+X.Cut 90°



- Formgenauer Präzisionsanschliff
- Optimiertes Eindringverhalten
- Hohe Rundlaufgenauigkeit
- Glatter Zylinderschaft mit Toleranz h6
- Senkwinkel 90°
- Oberfläche X.Cut beschichtet

- High precision point geometry
- Easy penetration and high accuracy
- High concentricity
- Straight shank in tolerance h6
- Point angle 90°
- With X.Cut coating

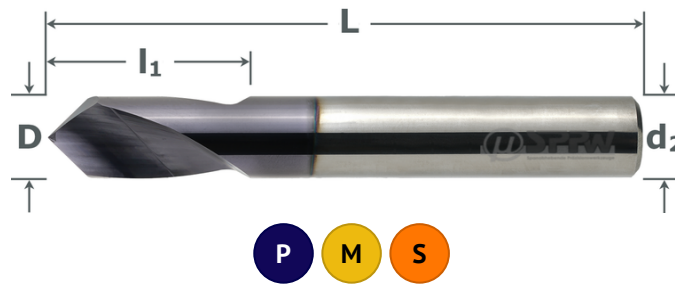

VHM	X Cut
ISO 10898	90°
DIN 6535HA	DIN 6535HB

B

ØD h6	Ød2 h6	L	l1	Art. No.
2	2	40	8	6234970200
3	3	45	10	6234970300
4	4	50	12	6234970400
5	5	50	15	6234970500
6	6	50	18	6234970600

ØD h6	Ød2 h6	L	l1	Art. No.
8	8	60	23	6234970800
10	10	70	24	6234971000
12	12	70	24	6234971200
16	16	80	26	6234971600
20	20	100	35	6234972000

623492 - Schaft DIN 6535 HB | Weldon Shank

ØD h6	Ød2 h6	L	l1	Schaft	Art. No.
6	6	50	18	HB	6234920600
8	8	60	23	HB	6234920800
10	10	70	24	HB	6234921000

ØD h6	Ød2 h6	L	l1	Schaft	Art. No.
12	12	70	24	HB	6234921200
16	16	80	26	HB	6234921600
20	20	100	35	HB	6234922000

623 397

NC-Anbohrer VHM+X.Cut 90° Lang
Carbide NC Spotting Drills+X.Cut 90° Long Series



- Formgenauer Präzisionsanschliff
- Lange Version für Zugangsprobleme
- Hohe Rundlauf- und Formgenauigkeit
- Glatter Zylinderschaft mit Toleranz h6
- Senkwinkel 90°
- Oberfläche X.Cut beschichtet

- High precision point geometry
- Long version for access problems
- High concentricity
- Straight shank in tolerance h6
- Point angle 90°
- With X.Cut coating

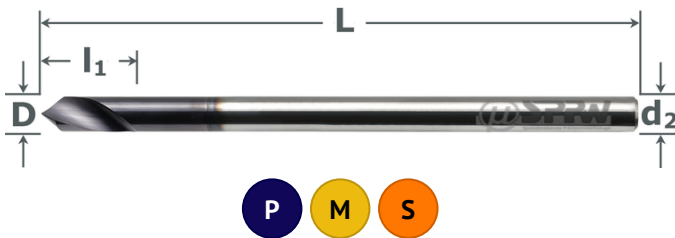

VHM	X Cut
ISO 10898	90°
DIN 6535HA	L lang

ØD h6	Ød2 h6	L	l1	Art. No.
4	4	100	12	6233970400
5	5	120	15	6233970500
6	6	140	20	6233970600
8	8	140	25	6233970800

ØD h6	Ød2 h6	L	l1	Art. No.
10	10	170	25	6233971000
12	12	170	30	6233971200
16	16	200	35	6233971600
20	20	200	40	6233972000

623 500**NC-Anbohrer VHM 120°
Carbide NC Spotting Drills 120°****B**

- Formgenauer Präzisionsanschliff
- Optimiertes Eindringverhalten
- Glatter Zylinderschaft mit Toleranz h6
- Senkwinkel 120°
- Oberfläche blank

- High precision point geometry
- Easy penetration and high accuracy
- Straight shank in tolerance h6
- Point angle 120°
- Bright finish

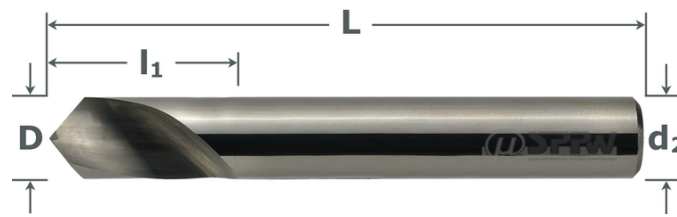

VHM	blank
ISO 10898	120°
DIN 6535HA	DIN 6535HB

ØD h6	Ød2 h6	L	l1	Art. No.
2	2	40	8	6235000200
3	3	45	10	6235000300
4	4	50	12	6235000400
5	5	50	15	6235000500
6	6	50	18	6235000600

ØD h6	Ød2 h6	L	l1	Art. No.
8	8	60	23	6235000800
10	10	70	24	6235001000
12	12	70	24	6235001200
16	16	80	26	6235001600
20	20	100	35	6235002000

623501 - Schaft DIN 6535 HB | Weldon Shank

ØD h6	Ød2 h6	L	l1	Schaft	Art. No.
6	6	50	18	HB	6235010600
8	8	60	23	HB	6235010800
10	10	70	24	HB	6235011000

ØD h6	Ød2 h6	L	l1	Schaft	Art. No.
12	12	70	24	HB	6235011200
16	16	80	26	HB	6235011600
20	20	100	35	HB	6235012000

623 580**NC-Anbohrer VHM 120° Lang
Carbide NC Spotting Drills 120° Long Series**

- Formgenauer Präzisionsanschliff
- Lange Version für Zugangsprobleme
- Hohe Rundlauf- und Formgenauigkeit
- Glatter Zylinderschaft mit Toleranz h6
- Senkwinkel 120°
- Oberfläche blank

- High precision point geometry
- Long version for access problems
- High concentricity
- Straight shank in tolerance h6
- Point angle 120°
- Bright finish



VHM	blank
ISO 10898	120°
DIN 6535HA	L lang

ØD h6	Ød2 h6	L	l1	Art. No.
4	4	100	12	6235800400
5	5	120	15	6235800500
6	6	140	20	6235800600

ØD h6	Ød2 h6	L	l1	Art. No.
8	8	140	25	6235800800
10	10	170	25	6235801000
12	12	170	30	6235801200

623 507**NC-Anbohrer VHM+X.Cut 120°
Carbide NC Spotting Drills+X.Cut 120°**

- Formgenauer Präzisionsanschliff
- Optimiertes Eindringverhalten
- Hohe Rundlaufgenauigkeit
- Glatter Zylinderschaft mit Toleranz h6
- Senkwinkel 120°
- Oberfläche X.Cut beschichtet

- High precision point geometry
- Easy penetration and high accuracy
- High concentricity
- Straight shank in tolerance h6
- Point angle 120°
- With X.Cut coating

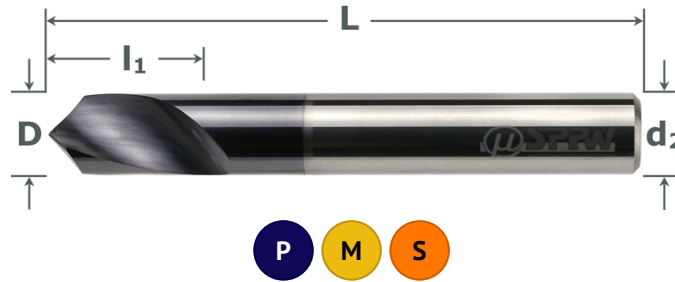

VHM	X Cut
ISO 10898	120°
DIN 6535HA	DIN 6535HB

B

ØD h6	Ød2 h6	L	l1	Art. No.
2	2	40	8	6235070200
3	3	45	10	6235070300
4	4	50	12	6235070400
5	5	50	15	6235070500
6	6	50	18	6235070600

ØD h6	Ød2 h6	L	l1	Art. No.
8	8	60	23	6235070800
10	10	70	24	6235071000
12	12	70	24	6235071200
16	16	80	26	6235071600
20	20	100	35	6235072000

623502 - Schaft DIN 6535 HB | Weldon Shank

ØD h6	Ød2 h6	L	l1	Schaft	Art. No.
6	6	50	18	HB	6235020600
8	8	60	23	HB	6235020800
10	10	70	24	HB	6235021000

ØD h6	Ød2 h6	L	l1	Schaft	Art. No.
12	12	70	24	HB	6235021200
16	16	80	26	HB	6235021600
20	20	100	35	HB	6235022000

623 587**NC-Anbohrer VHM+X.Cut 120° Lang
Carbide NC Spotting Drills+X.Cut 120° Long Series**

- Formgenauer Präzisionsanschliff
- Lange Version für Zugangsprobleme
- Hohe Rundlauf- und Formgenauigkeit
- Glatter Zylinderschaft mit Toleranz h6
- Senkwinkel 120°
- Oberfläche X.Cut beschichtet

- High precision point geometry
- Long version for access problems
- High concentricity
- Straight shank in tolerance h6
- Point angle 120°
- With X.Cut coating

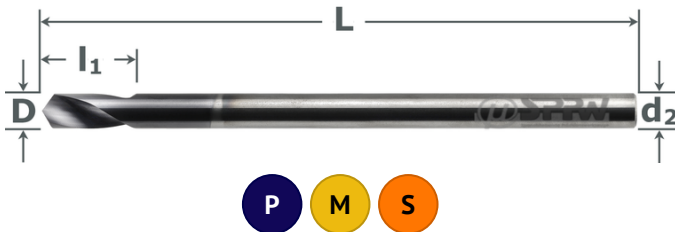

VHM	X Cut
ISO 10898	120°
DIN 6535HA	L lang

ØD h6	Ød2 h6	L	l1	Art. No.
4	4	100	12	6235870400
5	5	120	15	6235870500
6	6	140	20	6235870600

ØD h6	Ød2 h6	L	l1	Art. No.
8	8	140	25	6235870800
10	10	170	25	6235871000
12	12	170	30	6235871200

623 511**NC-Anbohrer VHM 142° Spannfläche**
Carbide NC Spotting Drills 142° Flat**B**

- Formgenauer Präzisionsanschliff
- Optimiertes Eindringverhalten
- Hohe Rundlaufgenauigkeit
- Ab Ø6 Schaft DIN 6535 HB
- 142° Spitze für HPC-Bohrer
- Oberfläche blank

- High precision point geometry
- Easy penetration and high accuracy
- High concentricity
- Ø6 and up shank DIN 6535 HB
- 142° point - spotting for HPC drills
- Bright finish

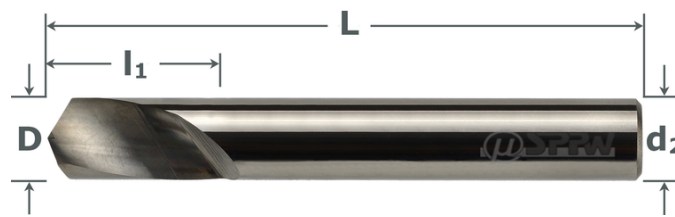

VHM	blank
ISO 10898	142°
DIN 6535HA	DIN 6535HB

ØD h6	Ød2 h6	L	l1	Schaft	Art. No.
3	3	45	10	HA	6235110300
4	4	50	12	HA	6235110400
5	5	50	15	HA	6235110500
6	6	50	18	HB	6235110600
8	8	60	23	HB	6235110800

ØD h6	Ød2 h6	L	l1	Schaft	Art. No.
10	10	70	24	HB	6235111000
12	12	70	24	HB	6235111200
16	16	80	26	HB	6235111600
20	20	100	35	HB	6235112000

623 512**NC-Anbohrer VHM+X.Cut 142° Spannfläche**
Carbide NC Spotting Drills+X.Cut 142° Flat

- Formgenauer Präzisionsanschliff
- Optimiertes Eindringverhalten
- Hohe Rundlaufgenauigkeit
- Ab Ø6 Schaft DIN 6535 HB
- 142° Spitze für HPC-Bohrer
- Oberfläche X.Cut beschichtet

- High precision point geometry
- Easy penetration and high accuracy
- High concentricity
- Ø6 and up shank DIN 6535 HB
- 142° point for HPC drills
- Bright finish or with X.Cut coating

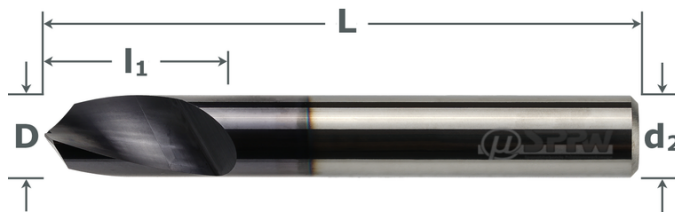

VHM	X Cut
ISO 10898	142°
DIN 6535HA	DIN 6535HB

ØD h6	Ød2 h6	L	l1	Schaft	Art. No.
3	3	45	10	HA	6235120300
4	4	50	12	HA	6235120400
5	5	50	15	HA	6235120500
6	6	50	18	HB	6235120600
8	8	60	23	HB	6235120800

ØD h6	Ød2 h6	L	l1	Schaft	Art. No.
10	10	70	24	HB	6235121000
12	12	70	24	HB	6235121200
16	16	80	26	HB	6235121600
20	20	100	35	HB	6235122000

123 640

NC-Anbohrer HSS-E05 60°
HSS-E05 NC Spotting Drills 60°



- Formgenauer Präzisionsanschliff
- Optimiertes Eindringverhalten
- Glatter Zylinderschaft mit Toleranz h6
- Senkwinkel 60°
- Oberfläche blank

- High precision point geometry
- Easy penetration and high accuracy
- Straight shank in tolerance h6
- Point angle 60°
- Bright finish

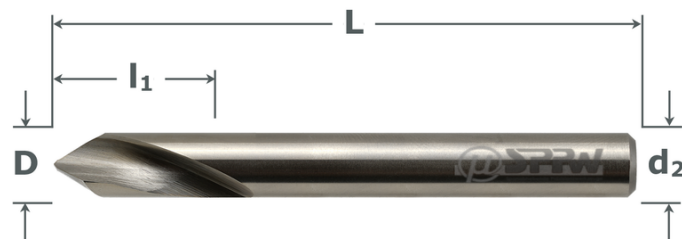

HSS E05	blank
ISO 10898	60°
DIN 1835A	



ØD h6	Ød2 h6	L	l1	Art. No.	ØD h6	Ød2 h6	L	l1	Art. No.
4	4	52	12	1236400400	10	10	89	25	1236401000
5	5	60	15	1236400500	12	12	102	30	1236401200
6	6	66	20	1236400600	16	16	115	35	1236401600
8	8	79	25	1236400800	20	20	131	40	1236402000

— INFO —

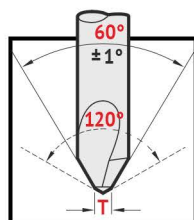
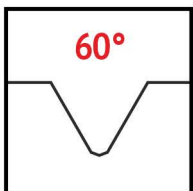

NC-Anbohrer mit Senkwinkel 60° haben eine verstärkte Spitze mit Spitzenwinkel 120°. Sie sind daher deutlich stabiler!

NC spot drills with sinking angle 60° have a reinforced tip with point angle 120°. They are therefore significantly more stable!

123 370**NC-Anbohrer HSS-E05 90°
HSS-E05 NC Spotting Drills 90°****B**

- Formgenauer Präzisionsanschliff
- Optimiertes Eindringverhalten
- Glatter Zylinderschaft mit Toleranz h6
- Senkwinkel 90°
- Oberfläche blank

- High precision point geometry
- Easy penetration and high accuracy
- Straight shank in tolerance h6
- Point angle 90°
- Bright finish

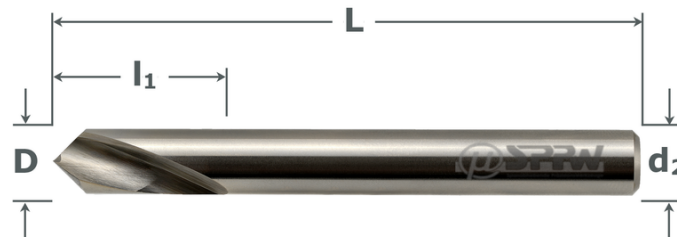

HSS E05	blank
ISO 10898	90°
DIN 1835A	DIN 1835B

ØD h7	Ød2 h6	L	l1	Art. No.	ØD h7	Ød2 h6	L	l1	Art. No.
2	2	49	8	1233700200	12	12	102	30	1233701200
3	3	50	10	1233700300	14	14	115	35	1233701400
4	4	52	12	1233700400	16	16	115	35	1233701600
5	5	60	15	1233700500	18	18	130	40	1233701800
6	6	66	20	1233700600	20	20	131	40	1233702000
8	8	79	25	1233700800	25	25	138	45	1233702500
10	10	89	25	1233701000					

123371 - Schaft DIN 1835 B | Weldon Shank

ØD h7	Ød2 h6	L	l1	Art. No.	ØD h7	Ød2 h6	L	l1	Art. No.
6	6	66	20	1233710600	12	12	102	30	1233711200
8	8	79	25	1233710800	16	16	115	35	1233711600
10	10	89	25	1233711000	20	20	131	40	1233712000

123 390**NC-Anbohrer HSS-E05 90° Lang
HSS-E05 NC Spotting Drills 90° Long Series**

- Formgenauer Präzisionsanschliff
- Lange Version für Zugangsprobleme
- Hohe Rundlauf- und Formgenauigkeit
- Glatter Zylinderschaft mit Toleranz h6
- Senkwinkel 90°
- Oberfläche blank

- High precision point geometry
- Long version for access problems
- High concentricity
- Straight shank in tolerance h6
- Point angle 90°
- Bright finish



HSS E05	blank
ISO 10898	90°
DIN 1835A	L lang

ØD h7	Ød2 h6	L	l1	Art. No.	ØD h7	Ød2 h6	L	l1	Art. No.
1	1	50	6	1233900100	8	8	140	25	1233900800
2	2	60	8	1233900200	10	10	170	25	1233901000
3	3	80	10	1233900300	12	12	170	30	1233901200
4	4	100	12	1233900400	16	16	200	35	1233901600
5	5	120	15	1233900500	20	20	200	40	1233902000
6	6	140	20	1233900600					

123 310

NC-Anbohrer HSS-E05 90° Links HSS-E05 NC Spotting Drills 90° Left Hand



- Formgenauer Präzisionsanschliff
- Hohe Rundlauf- und Formgenauigkeit
- Linksschneidend für Drehmaschinen
- Glatter Zylinderschaft mit Toleranz h6
- Senkwinkel 90°
- Oberfläche blank

- High precision point geometry
- High concentricity and high accuracy
- Left hand cutting, especially for lathes
- Straight shank in tolerance h6
- Point angle 90°
- Bright finish

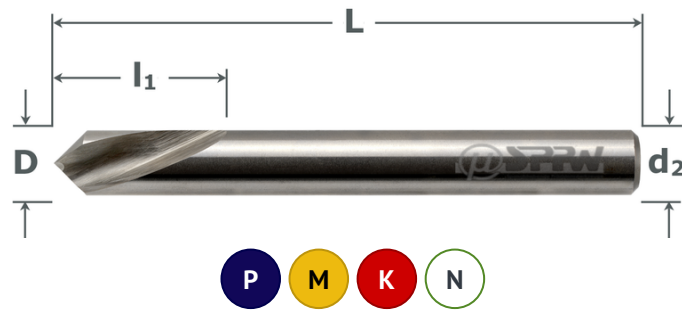

HSS E05	blank
ISO 10898	90°
DIN 1835A	LH links

B

ØD h6	Ød2 h6	L	l1	Art. No.	ØD h6	Ød2 h6	L	l1	Art. No.
3	3	50	10	1233100300	8	8	79	25	1233100800
4	4	52	12	1233100400	10	10	89	25	1233101000
5	5	60	15	1233100500	12	12	102	30	1233101200
6	6	66	20	1233100600	16	16	115	35	1233101600

123 440

NC-Anbohrer HSS-E05 90° mit MK-Schaft HSS-E05 NC Spotting Drills 90° with Morse Taper Shank



- Formgenauer Präzisionsanschliff
- Optimiertes Eindringverhalten
- Ausführung mit MK-Schaft
- Senkwinkel 90°
- Oberfläche blank

- High precision point geometry
- Easy penetration and high accuracy
- Morse Taper Shank
- Point angle 90°
- Bright finish

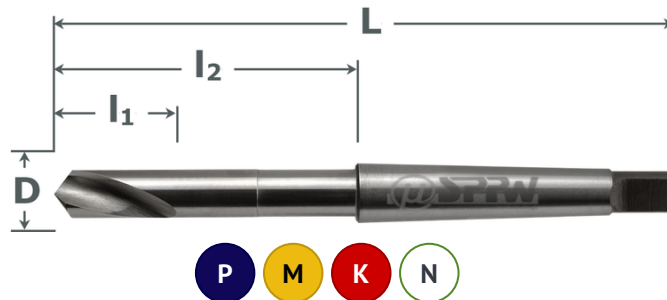

HSS E05	blank
ISO 10898	90°
MK MTS	

ØD h10	MK Nr.	L	l1	l2	Art. No.	ØD h10	MK Nr.	L	l1	l2	Art. No.
10	1	130	25	64	1234401000	20	2	148	40	68	1234402000
12	1	130	30	64	1234401200	25	3	171	45	72	1234402500
16	2	148	35	68	1234401600						

123 450**NC-Anbohrer HSS-E05+A.Cut 90°
HSS-E05 NC Spotting Drills+A.Cut 90°****B**

- Formgenauer Präzisionsanschliff
- Optimiertes Eindringverhalten
- Glatter Zylinderschaft mit Toleranz h6
- Senkwinkel 90°
- Oberfläche A.Cut beschichtet

- High precision point geometry
- Easy penetration and high accuracy
- Straight shank in tolerance h6
- Point angle 90°
- With A.Cut coating



HSS E05	A Cut
ISO 10898	90°
DIN 1835A	DIN 1835B

ØD h7	Ød2 h6	L	l1	Art. No.
2	2	49	8	1234500200
3	3	50	10	1234500300
4	4	52	12	1234500400
5	5	60	15	1234500500
6	6	66	20	1234500600
8	8	79	25	1234500800
10	10	89	25	1234501000

ØD h7	Ød2 h6	L	l1	Art. No.
12	12	102	30	1234501200
14	14	115	35	1234501400
16	16	115	35	1234501600
18	18	130	40	1234501800
20	20	131	40	1234502000
25	25	138	45	1234502500

123451 - Schaft DIN 1835 B | Weldon Shank

ØD h7	Ød2 h6	L	l1	Art. No.
6	6	66	20	1234510600
8	8	79	25	1234510800
10	10	89	25	1234511000

ØD h7	Ød2 h6	L	l1	Art. No.
12	12	102	30	1234511200
16	16	115	35	1234511600
20	20	131	40	1234512000

— INFO —**HSS-E NC-Anbohrer - Oberflächenbehandlungen
HSS-E Spotting Drills - Surface Treatments**

blank	Ohne Beschichtung Without coating	
A Cut	Titan-Nitrid (2.300 HV) Titanium Nitride (2300 HV)	
X Cut	Titan-Aluminium-Nitrid (3.500 HV) Titanium-Alumnum-Nitride (3500 HV)	

123 590**NC-Anbohrer HSS-E05+X.Cut 90°
HSS-E05 NC Spotting Drills+X.Cut 90°**

- Formgenauer Präzisionsanschliff
- Optimiertes Eindringverhalten
- Glatter Zylinderschaft mit Toleranz h6
- Senkwinkel 90°
- Oberfläche X5.Cut beschichtet

- High precision point geometry
- Easy penetration and high accuracy
- Straight shank in tolerance h6
- Point angle 90°
- With X5.Cut coating

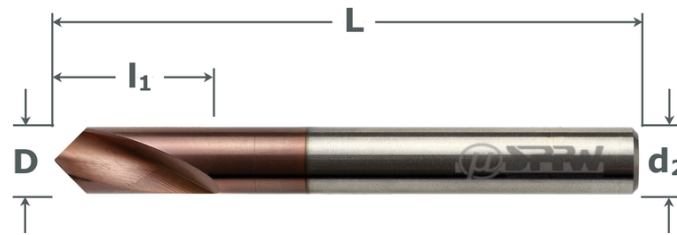

HSS E05	X Cut
ISO 10898	90°
DIN 1835A	DIN 1835B

B

ØD h7	Ød2 h6	L	l1	Art. No.
2	2	49	8	1235900200
3	3	50	10	1235900300
4	4	52	12	1235900400
5	5	60	15	1235900500
6	6	66	20	1235900600
8	8	79	25	1235900800
10	10	89	25	1235901000

ØD h7	Ød2 h6	L	l1	Art. No.
12	12	102	30	1235901200
14	14	115	35	1235901400
16	16	115	35	1235901600
18	18	130	40	1235901800
20	20	131	40	1235902000
25	25	138	45	1235902500

123591 - Schaft DIN 1835 B | Weldon Shank

ØD h7	Ød2 h6	L	l1	Art. No.
6	6	66	20	1235910600
8	8	79	25	1235910800
10	10	89	25	1235911000

ØD h7	Ød2 h6	L	l1	Art. No.
12	12	102	30	1235911200
16	16	115	35	1235911600
20	20	131	40	1235912000

123 397**NC-Anbohrer HSS-E05+X.Cut 90° Lang
HSS-E05 NC Spotting Drills+X.Cut 90° Long Series**

- Formgenauer Präzisionsanschliff
- Lange Version für Zugangsprobleme
- Hohe Rundlauf- und Formgenauigkeit
- Glatter Zylinderschaft mit Toleranz h6
- Senkwinkel 90°
- Oberfläche X.Cut beschichtet

- High precision point geometry
- Long version for access problems
- High concentricity
- Straight shank in tolerance h6
- Point angle 90°
- With X.Cut coating



HSS E05	X Cut
ISO 10898	90°
DIN 1835A	L lang

ØD h7	Ød2 h6	L	l1	Art. No.
1	1	50	6	1233970100
2	2	60	8	1233970200
3	3	80	10	1233970300
4	4	100	12	1233970400
5	5	120	15	1233970500
6	6	140	20	1233970600

ØD h7	Ød2 h6	L	l1	Art. No.
8	8	140	25	1233970800
10	10	170	25	1233971000
12	12	170	30	1233971200
16	16	200	35	1233971600
20	20	200	40	1233972000

123 380**NC-Anbohrer HSS-E05 120°
HSS-E05 NC Spotting Drills 120°****B**

- Formgenauer Präzisionsanschliff
- Optimiertes Eindringverhalten
- Glatter Zylinderschaft Toleranz h6
- Senkwinkel 120°
- Oberfläche blank

- High precision point geometry
- Easy penetration and high accuracy
- Straight shank in tolerance h6
- Point angle 120°
- Bright finish



HSS E05	blank
ISO 10898	120°
DIN 1835A	DIN 1835B

ØD h7	Ød2 h6	L	l1	Art. No.	ØD h7	Ød2 h6	L	l1	Art. No.
2	2	49	8	1233800200	12	12	102	30	1233801200
3	3	50	10	1233800300	14	14	115	35	1233801400
4	4	52	12	1233800400	16	16	115	35	1233801600
5	5	60	15	1233800500	18	18	130	40	1233801800
6	6	66	20	1233800600	20	20	131	40	1233802000
8	8	79	25	1233800800	25	25	138	45	1233802500
10	10	89	25	1233801000					

123381 - Schaft DIN 1835 B | Weldon Shank

ØD h7	Ød2 h6	L	l1	Art. No.	ØD h7	Ød2 h6	L	l1	Art. No.
6	6	66	20	1233810600	12	12	102	30	1233811200
8	8	79	25	1233810800	16	16	115	35	1233811600
10	10	89	25	1233811000	20	20	131	40	1233812000

123 580**NC-Anbohrer HSS-E05 120° Lang
HSS-E05 NC Spotting Drills 120° Long Series**

- Formgenauer Präzisionsanschliff
- Lange Version für Zugangsprobleme
- Hohe Rundlauf- und Formgenauigkeit
- Glatter Zylinderschaft mit Toleranz h6
- Senkwinkel 120°
- Oberfläche blank

- High precision point geometry
- Long version for access problems
- High concentricity
- Straight shank in tolerance h6
- Point angle 120°
- Bright finish



HSS E05	blank
ISO 10898	120°
DIN 1835A	L lang

ØD h6	Ød2 h6	L	l1	Art. No.	ØD h6	Ød2 h6	L	l1	Art. No.
1	1	50	6	1235800100	8	8	140	25	1235800800
2	2	60	8	1235800200	10	10	170	25	1235801000
3	3	80	10	1235800300	12	12	170	30	1235801200
4	4	100	12	1235800400	16	16	200	35	1235801600
5	5	120	15	1235800500	20	20	200	40	1235802000
6	6	140	20	1235800600					

123 320

NC-Anbohrer HSS-E05 120° Links HSS-E05 NC Spotting Drills 120° Left Hand



- Formgenauer Präzisionsanschliff
- Hohe Rundlauf- und Formgenauigkeit
- Linksschneidend für Drehmaschinen
- Glatter Zylinderschaft mit Toleranz h6
- Senkwinkel 120°
- Oberfläche blank

- High precision point geometry
- High concentricity and high accuracy
- Left hand cutting for lathes
- Straight shank in tolerance h6
- Point angle 120°
- Bright finish

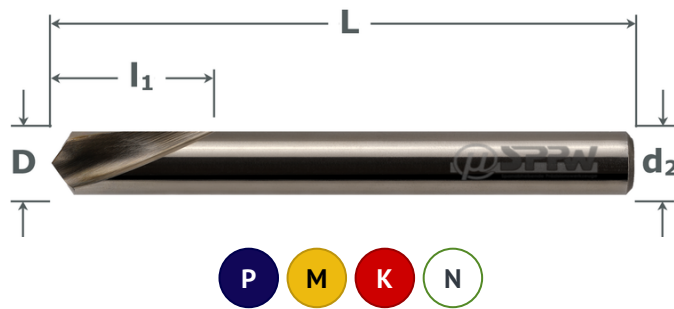

HSS E05	blank
ISO 10898	120°
DIN 1835A	LH links

B

ØD h6	Ød2 h6	L	l1	Art. No.	ØD h6	Ød2 h6	L	l1	Art. No.
3	3	50	10	1233200300	6	6	66	20	1233200600
4	4	52	12	1233200400	8	8	79	25	1233200800
5	5	60	15	1233200500	10	10	89	25	1233201000

123 470

NC-Anbohrer HSS-E05 120° mit MK-Schaft HSS-E05 NC Spotting Drills 120° with Morse Taper Shank



- Präziser Sonderanschliff
- Hohe Rundlauf- und Formgenauigkeit
- Ausführung mit MK-Schaft
- Senkwinkel 120°
- Oberfläche blank

- High precision special point geometry
- High concentricity and high accuracy
- Morse Taper Shank
- Point angle 120°
- Bright finish

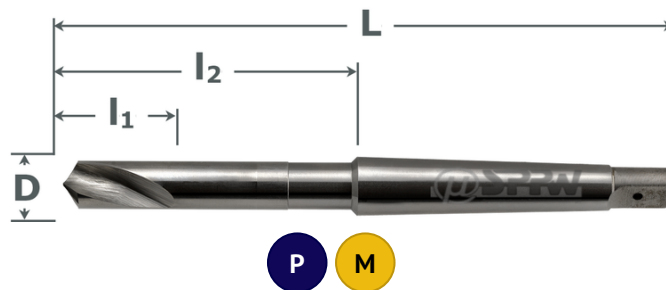

HSS E05	blank
ISO 10898	120°
MK MTS	

ØD h10	MK Nr.	L	l1	l2	Art. No.	ØD h10	MK Nr.	L	l1	l2	Art. No.
12	1	130	30	64	1234701200	20	2	148	40	68	1234702000
16	2	148	35	68	1234701600	25	3	171	45	72	1234702500

123 460**NC-Anbohrer HSS-E05+A.Cut 120°
HSS-E05 NC Spotting Drills+A.Cut 120°****B**

- Formgenauer Präzisionsanschliff
- Optimiertes Eindringverhalten
- Glatter Zylinderschaft Toleranz h6
- Senkwinkel 120°
- Oberfläche A.Cut beschichtet
- High precision point geometry
- Easy penetration and high accuracy
- Straight shank in tolerance h6
- Point angle 120°
- With A.Cut coating

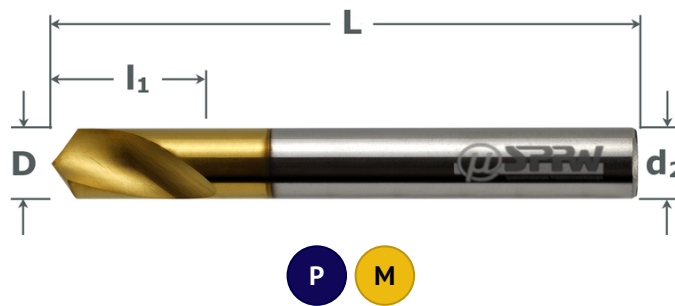

HSS E05	A Cut
ISO 10898	120°
DIN 1835A	DIN 1835B

ØD h7	Ød2 h6	L	l1	Art. No.
2	2	49	8	1234600200
3	3	50	10	1234600300
4	4	52	12	1234600400
5	5	60	15	1234600500
6	6	66	20	1234600600
8	8	79	25	1234600800
10	10	89	25	1234601000

ØD h7	Ød2 h6	L	l1	Art. No.
12	12	102	30	1234601200
14	14	115	35	1234601400
16	16	115	35	1234601600
18	18	130	40	1234601800
20	20	131	40	1234602000
25	25	138	45	1234602500

123461 - Schaft DIN 1835 B | Weldon Shank

ØD h7	Ød2 h6	L	l1	Art. No.
6	6	66	20	1234610600
8	8	79	25	1234610800
10	10	89	25	1234611000

ØD h7	Ød2 h6	L	l1	Art. No.
12	12	102	30	1234611200
16	16	115	35	1234611600
20	20	131	40	1234612000

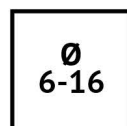
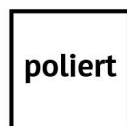
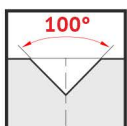
— INFO —**Anbohren 100° | Spotting 100° - Seite | page G2 Multi-V 668095**

123 600

NC-Anbohrer HSS-E05+X.Cut 120°
HSS-E05 NC Spotting Drills+X.Cut 120°



- Formgenauer Präzisionsanschliff
- Optimiertes Eindringverhalten
- Glatter Zylinderschaft Toleranz h6
- Senkwinkel 120°
- Oberfläche X5.Cut beschichtet
- High precision point geometry
- Easy penetration and high accuracy
- Straight shank in tolerance h6
- Point angle 120°
- With X5.Cut coating

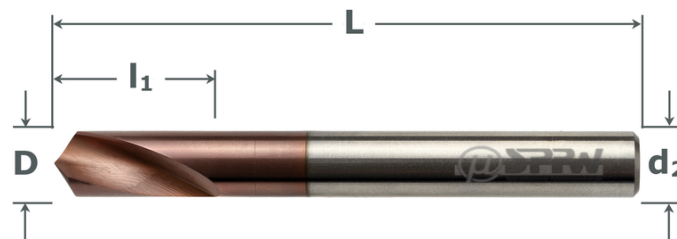

HSS E05	X Cut
ISO 10898	120°
DIN 1835A	DIN 1835B

B

ØD h7	Ød2 h6	L	l1	Art. No.
2	2	49	8	1236000200
3	3	50	10	1236000300
4	4	52	12	1236000400
5	5	60	15	1236000500
6	6	66	20	1236000600
8	8	79	25	1236000800
10	10	89	25	1236001000

ØD h7	Ød2 h6	L	l1	Art. No.
12	12	102	30	1236001200
14	14	115	35	1236001400
16	16	115	35	1236001600
18	18	130	40	1236001800
20	20	131	40	1236002000
25	25	138	45	1236002500

123601 - Schaft DIN 1835 B | Weldon Shank

ØD h7	Ød2 h6	L	l1	Art. No.
6	6	66	20	1236010600
8	8	79	25	1236010800
10	10	89	25	1236011000

ØD h7	Ød2 h6	L	l1	Art. No.
12	12	102	30	1236011200
16	16	115	35	1236011600
20	20	131	40	1236012000

123 587

NC-Anbohrer HSS-E05+X.Cut 120° Lang
HSS-E05 NC Spotting Drills+X.Cut 120° Long Series



- Formgenauer Präzisionsanschliff
- Lange Version für Zugangsprobleme
- Hohe Rundlauf- und Formgenauigkeit
- Glatter Zylinderschaft mit Toleranz h6
- Senkwinkel 120°
- Oberfläche X5 Cut beschichtet
- High precision point geometry
- Long version for access problems
- High concentricity
- Straight shank in tolerance h6
- Point angle 120°
- With X5.Cut coating



HSS E05	X Cut
ISO 10898	120°
DIN 1835A	L lang

ØD h6	Ød2 h6	L	l1	Art. No.
1	1	50	6	1235870100
2	2	60	8	1235870200
3	3	80	10	1235870300
4	4	100	12	1235870400
5	5	120	15	1235870500
6	6	140	20	1235870600

ØD h6	Ød2 h6	L	l1	Art. No.
8	8	140	25	1235870800
10	10	170	25	1235871000
12	12	170	30	1235871200
16	16	200	35	1235871600
20	20	200	40	1235872000

123 384**NC-Anbohrer HSS-E05 142°
HSS-E05 NC Spotting Drills 142°****B**

- Formgenauer Präzisionsanschliff
- Optimiertes Eindringverhalten
- Glatter Zylinderschaft mit Toleranz h6
- Senkwinkel 142°
- Oberfläche blank

- High precision point geometry
- Easy penetration and high accuracy
- Straight shank in tolerance h6
- Point angle 142°
- Bright finish

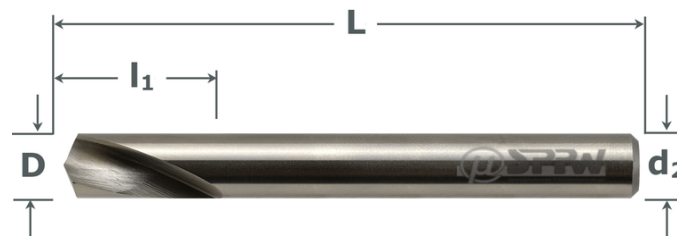

HSS E05	blank
ISO 10898	142°
DIN 1835A	

ØD h7	Ød2 h6	L	l1	Art. No.	ØD h7	Ød2 h6	L	l1	Art. No.
3	3	50	10	1233840300	10	10	89	25	1233841000
4	4	52	12	1233840400	12	12	102	30	1233841200
5	5	60	15	1233840500	16	16	115	35	1233841600
6	6	66	20	1233840600	20	20	131	40	1233842000
8	8	79	25	1233840800					

123 604**NC-Anbohrer HSS-E05+X.Cut 142°
HSS-E05 NC Spotting Drills+X.Cut 142°**

- Formgenauer Präzisionsanschliff
- Optimiertes Eindringverhalten
- Glatter Zylinderschaft mit Toleranz h6
- Senkwinkel 142°
- Oberfläche X5.Cut

- High precision point geometry
- Easy penetration and high accuracy
- Straight shank in tolerance h6
- Point angle 142°
- With X5.Cut coating

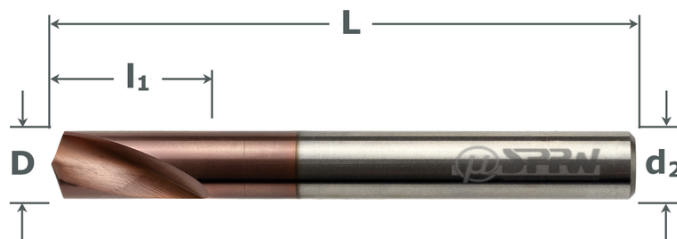

HSS E05	X Cut
ISO 10898	142°
DIN 1835A	

ØD h7	Ød2 h6	L	l1	Art. No.	ØD h7	Ød2 h6	L	l1	Art. No.
3	3	50	10	1236040300	10	10	89	25	1236041000
4	4	52	12	1236040400	12	12	102	30	1236041200
5	5	60	15	1236040500	16	16	115	35	1236041600
6	6	66	20	1236040600	20	20	131	40	1236042000
8	8	79	25	1236040800					

Duo MAG 60

NC-Anbohrer HSS-E05+X.Cut DuoMag Doppelseitig 60° HSS-E05 NC Spotting Drills+X.Cut DuoMag Double 60°



- Anbohren und Zentrieren
- Sonderanschliff mit verstärkter Spitze
- Spitzenwinkel 118°, Senkwinkel 60°
- Doppelseitig: 1 DuoMag = 2 Anbohrer
- Oberfläche X5.Cut beschichtet
- Spotting and centering
- Special geometry, reinforced point
- Point 118°, chamfering angle 60°
- Double: 1 DuoMag = 2 spotting drills
- With X5.Cut coating

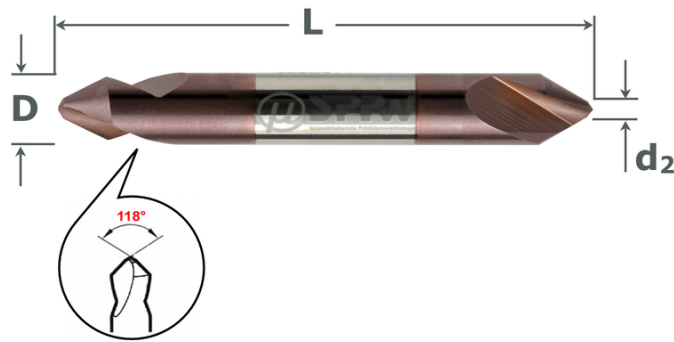

HSS E05	X Cut
60°	2 ENDS

B



124607 - kurz | short

ØD h7	Ød2 ±0,2	L ±1	a ±1°	Art. No.
3	0,5	40	60°	1246070300
4	1	45	60°	1246070400
6	2	55	60°	1246070600
8	2,5	65	60°	1246070800

ØD h7	Ød2 ±0,2	L ±1	a ±1°	Art. No.
10	3	75	60°	1246071000
12	3,5	85	60°	1246071200
16	4	90	60°	1246071600
20	5	100	60°	1246072000

124617 - OAL:100

ØD h7	Ød2 ±0,2	L ±1	a ±1°	Art. No.
3	0,5	100	60°	1246170300
4	1	100	60°	1246170400
6	2	100	60°	1246170600

ØD h7	Ød2 ±0,2	L ±1	a ±1°	Art. No.
8	2,5	100	60°	1246170800
10	3	100	60°	1246171000
12	3,5	100	60°	1246171200

124627 - OAL:150

ØD h7	Ød2 ±0,2	L ±1	a ±1°	Art. No.
8	2,5	150	60°	1246270800
10	3	150	60°	1246271000
12	3,5	150	60°	1246271200

ØD h7	Ød2 ±0,2	L ±1	a ±1°	Art. No.
16	4	150	60°	1246271600
20	5	150	60°	1246272000

— INFO —

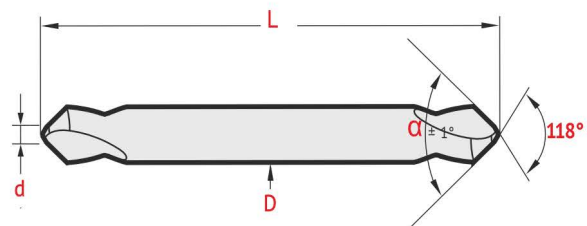
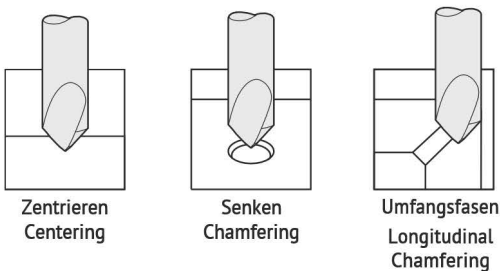

Duo MAG 90

NC-Anbohrer HSS-E05+X.Cut DuoMag Doppelseitig 90° HSS-E05 NC Spotting Drills+X.Cut DuoMag Double 90°



B

- Anbohren und Zentrieren
- Sonderanschiff mit verstärkter Spitze
- Spitzenwinkel 118°, Senkwinkel 90°
- Doppelseitig: 1 DuoMag = 2 Anbohrer
- Oberfläche X5.Cut beschichtet
- Spotting and centering
- Special geometry, reinforced point
- Point 118°, chamfering angle 90°
- Double: 1 DuoMag = 2 spotting drills
- With X5.Cut coating

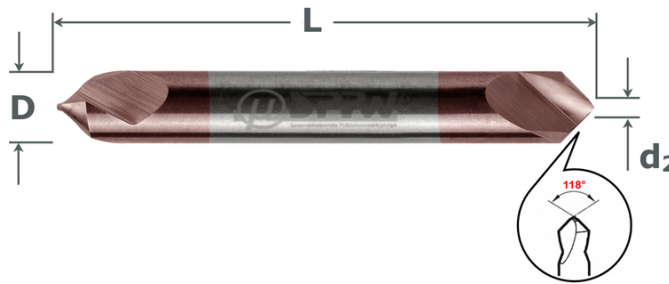

HSS E05	X Cut
90°	2 ENDS



124907 - kurz | short

ØD	Ød2	L	a	Art. No.
h7	±0,2	±1	±1°	
3	0,5	40	90°	1249070300
4	1	45	90°	1249070400
6	2	55	90°	1249070600
8	2,5	65	90°	1249070800

ØD	Ød2	L	a	Art. No.
h7	±0,2	±1	±1°	
10	3	75	90°	1249071000
12	3,5	85	90°	1249071200
16	4	90	90°	1249071600
20	5	100	90°	1249072000

124917 - OAL:100

ØD	Ød2	L	a	Art. No.
h7	±0,2	±1	±1°	
3	0,5	100	90°	1249170300
4	1	100	90°	1249170400
6	2	100	90°	1249170600

ØD	Ød2	L	a	Art. No.
h7	±0,2	±1	±1°	
8	2,5	100	90°	1249170800
10	3	100	90°	1249171000
12	3,5	100	90°	1249171200

124927 - OAL:150

ØD	Ød2	L	a	Art. No.
h7	±0,2	±1	±1°	
8	2,5	150	90°	1249270800
10	3	150	90°	1249271000
12	3,5	150	90°	1249271200

ØD	Ød2	L	a	Art. No.
h7	±0,2	±1	±1°	
16	4	150	90°	1249271600
20	5	150	90°	1249272000

— INFO —

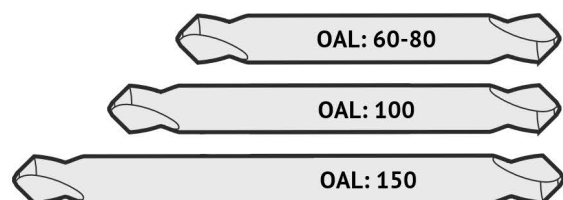
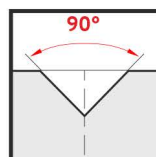
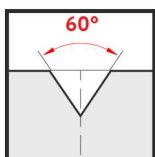

624 907

DuoMag NC-Anbohrer VHM+X.Cut Doppelseitig 90°
DuoMag Carbide NC Spotting Drills X.Cut Double End 90°



- Anbohren und Zentrieren
- Sonderanschliff mit verstärkter Spitze
- Spitzwinkel 118°, Senkwinkel 90°
- Doppelseitig: 1 DuoMag = 2 Anbohrer
- Oberfläche X.Cut beschichtet

- Spotting and centering
- Special geometry, reinforced point
- Point angle 118°, chamfer angle 90°
- Double: 1 DuoMag = 2 spotting drills
- With X.Cut coating

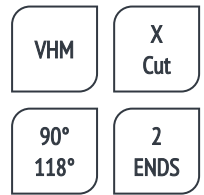

B



$\varnothing D$ h6	$\varnothing d$	L	a	Art. No.	$\varnothing D$ h6	$\varnothing d$	L	a	Art. No.
3	0,5	40	90°	6249070300	8	2,5	65	90°	6249070800
4	1	45	90°	6249070400	10	3	75	90°	6249071000
6	2	55	90°	6249070600	12	3,5	85	90°	6249071200

— INFO —

1 DuoMag = 2 Anbohrer

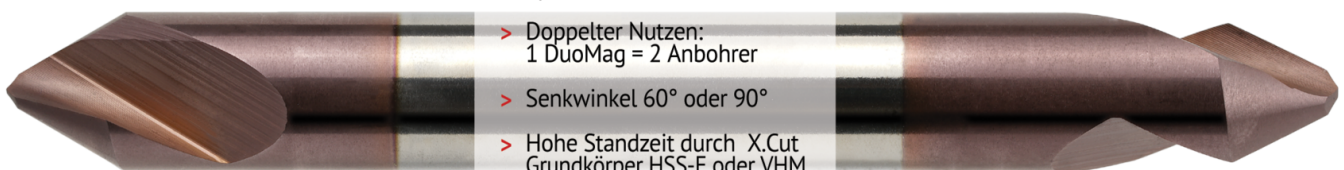

- > Besonders stabile, verstärkte Spitze 118°
- > Doppelter Nutzen:
1 DuoMag = 2 Anbohrer
- > Senkwinkel 60° oder 90°
- > Hohe Standzeit durch X.Cut Grundkörper HSS-E oder VHM
- > Verschiedene Ausführungen:
Kurz, Lang oder Überlang



[DE] **Stufenbohren**
[EN] **Stepdrilling**



passion for precision
[Leidenschaft für Präzision]



Mini-Kurzstufenbohrer VHM

Mini Carbide Step Drills

Art.No./Page

		VHM	X Cut	90°	DIN 6535HA	Mini	623 408 Seite C 1
--	--	-----	-------	-----	------------	------	-----------------------------

Kurzstufenbohrer VHM

Carbide Step Drills

Art.No./Page

		VHM	X Cut	90°	DIN 6535HA		623 407 Seite C 2
--	--	-----	-------	-----	------------	--	-----------------------------

		VHM	X Cut	180°	DIN 6535HA		623 417 Seite C 2
--	--	-----	-------	------	------------	--	-----------------------------

Kernloch-Kurzstufenbohrer HSS-E05

HSS-E05 Thread Hole Step Drills

Art.No./Page

		HSS E05	blank	90°	ZYL		123 560 Seite C 3
--	--	---------	-------	-----	-----	--	-----------------------------

		HSS E05	X Cut	90°	ZYL		123 567 Seite C 3
--	--	---------	-------	-----	-----	--	-----------------------------

Kurzstufenbohrer HSS-E05

HSS-E05 Step Drills

Art.No./Page

		HSS E05	blank	90°	ZYL		123 400 Seite C 4
--	--	---------	-------	-----	-----	--	-----------------------------

		HSS E05	X Cut	90°	ZYL		123 407 Seite C 4
--	--	---------	-------	-----	-----	--	-----------------------------

		HSS E05	blank	90°	ZYL	L lang	123 430 Seite C 5
--	--	---------	-------	-----	-----	--------	-----------------------------

		HSS E05	X Cut	90°	ZYL	L lang	123 437 Seite C 5
--	--	---------	-------	-----	-----	--------	-----------------------------

		HSS E05	blank	180°	ZYL		123 410 Seite C 6
--	--	---------	-------	------	-----	--	-----------------------------

		HSS E05	X Cut	180°	ZYL		123 417 Seite C 6
--	--	---------	-------	------	-----	--	-----------------------------

— INFO —



SONDER | SPECIALS

Wir liefern Sonderanfertigungen in Ihrer gewünschten Abmessung!
We supply special tools in your desired dimensions!





- Für Gewindekernlöcher (DIN 336-1)
- Für Gewinde ab M0,8
- Fluchtgenaues Bohren und Senken
- Senkwinkel 90°
- Oberfläche X.Cut beschichtet
- For thread holes (DIN 336-1)
- For threads starting from M0,8
- Drilling, chamfering in one operation
- Chamfer angle 90°
- With X.Cut coating

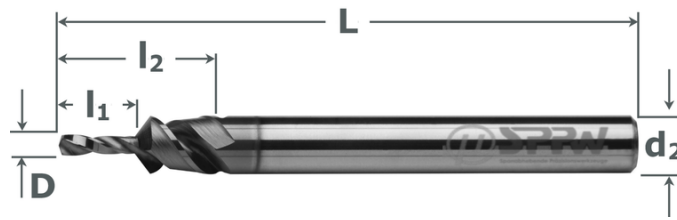

VHM	X Cut
90°	DIN 6535HA
Mini	



ØM	Ød2 h6	ØD ±0,01	L ±1	l1 1	l2	a	Art. No.
0,8	3	0,6	39	2,4	6	90°	6234080080
0,9	3	0,7	39	2,8	7	90°	6234080090
1	3	0,75	39	2,9	7	90°	6234080100
1,2	3	0,95	39	3,7	9	90°	6234080120
1,4	3	1,1	39	4,2	10	90°	6234080140
1,6	3	1,25	39	4,7	11	90°	6234080160

ØM	Ød2 h6	ØD ±0,01	L ±1	l1 1	l2	a	Art. No.
2	4	1,6	51	5,6	13	90°	6234080200
2,5	4	2,05	51	7,5	17	90°	6234080250
3	6	2,5	66	8,8	20	90°	6234080300
4	6	3,3	66	11,4	24	90°	6234080400
5	6	4,2	66	13,6	28	90°	6234080500
6	8	5	79	16,5	31	90°	6234080600

— INFO —

Modul.P: Modulare Senk- und Stufenwerkzeuge | Modular Chamfering Tools



Größe 0 - Size 0



Größe 1 - Size 1

Modul.P ist ein Modulares Werkzeugsystem zum Herstellen von Stufenbohrungen bzw. geführten Senkungen. Es besteht aus 3 Teilen:

- Führungszapfen oder Pilotbohrer für Durchgangslöcher
- Senker
- Halter

Modul.P wird in 3 Größenklassen angeboten: 0-klein, 1-mittel und 2-groß. Über 200 Einzelelemente ermöglichen über 10.000 Kombinationen. Die Elemente sind nur innerhalb ihrer Größenklasse (0-1-2) kombinierbar.

Größe 2 - Size 2

Modul.P is a modular tool for counterboring and -sinking. It is made of 3 components:

- Pilot or pilot drill for through holes
- Countersink
- Tool holder

Modul.P is available in 3 size classes: 0-small, 1-medium and 2-large. Over 200 components allow for over 10,000 combinations. The components can only be combined within their size class (0-1-2).

623 407**Kurzstufenbohrer VHM+X.Cut 90°
Carbide Step Drills+X.Cut 90°**

- Für Gewindekernlöcher (DIN 336-1)
- Fluchtgenaues Bohren und Senken
- Besonders für NC-Maschinen
- Senkwinkel 90°
- Oberfläche X.Cut beschichtet
- For thread holes (DIN 336-1)
- Drilling, chamfering in one operation
- Best suited for nc-machines
- Chamfer angle 90°
- With X.Cut coating

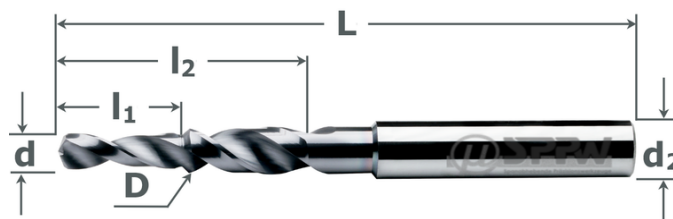

ØM	ØD	Ød	Ød2	L	l1	l2	a	Art. No.
	h8	h8	h6					
3	3,4	2,5	6	62	8,8	20	90°	6234070300
4	4,5	3,3	6	66	11,4	24	90°	6234070400
5	5,5	4,2	6	66	13,6	28	90°	6234070500
6	6,6	5	8	79	16,5	34	90°	6234070600

ØM	ØD	Ød	Ød2	L	l1	l2	a	Art. No.
	h8	h8	h6					
8	9	6,8	10	89	21	47	90°	6234070800
10	11	8,5	12	102	25,5	55	90°	6234071000
12	13,5	10,2	14	107	30	60	90°	6234071200

623 417**Kurzstufenbohrer VHM+X.Cut 180°
Carbide Step Drills+X.Cut 180°**

- Schraubendurchgangslöcher DIN 273
- Senkung nach DIN 74
- Fluchtgenaues Bohren und Senken
- Senkwinkel 180°
- Oberfläche X.Cut beschichtet
- For through holes (DIN 273)
- For screws with chamfer 180°
- Drilling, chamfering in one operation
- High concentricity
- With X.Cut coating

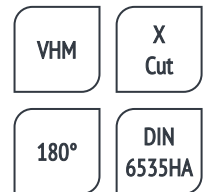
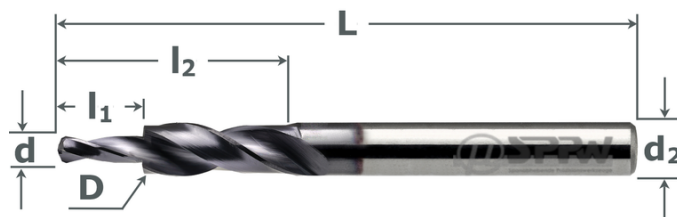

ØM	ØD	Ød	Ød2	L	l1	l2	a	Art. No.
	h8	h8	h6					
3	6	3,4	6	64	9	28	180°	6234170300
4	8	4,5	8	79	11	37	180°	6234170400
5	10	5,5	10	89	13	43	180°	6234170500
6	11	6,6	12	102	15	55	180°	6234170600

ØM	ØD	Ød	Ød2	L	l1	l2	a	Art. No.
	h8	h8	h6					
8	15	9	16	115	19	60	180°	6234170800
10	18	11	18	123	23	62	180°	6234171000
12	20	13,5	20	131	27	66	180°	6234171200

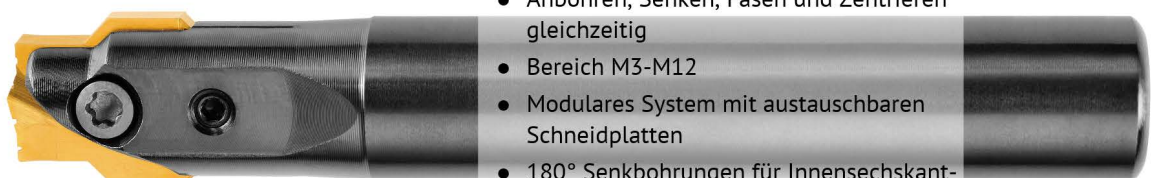
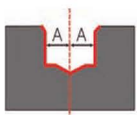
— INFO —**Modulare 4-in-1-Formbohrer | Modular 4-in-1-Drills**

- Anbohren, Senken, Fasen und Zentrieren gleichzeitig
- Bereich M3-M12
- Modulares System mit austauschbaren Schneidplatten
- 180° Senkbohrungen für Innensechskant- und Zylinderschrauben

123 560**Kernloch-Kurzstufenbohrer HSS-E05 90°
HSS-E05 Thread Hole Step Drills 90°**

- Für Gewindekernlöcher (DIN 336-1)
- Hohe Rundlaufgenauigkeit
- Fluchtgenaues Bohren und Senken
- Senkwinkel 90°
- Oberfläche blank
- For thread holes (DIN 336-1)
- High concentricity
- Drilling, chamfering in one operation
- Chamfer angle 90°
- Bright finish

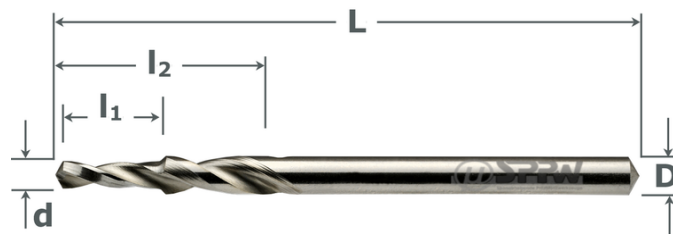

HSS E05	blank
90°	ZYL



ØM	ØD h8	Ød ±0,05	L	l1	l2	a ±1°	Art. No.
3	3,4	2,5	52	8	20	90°	1235600300
4	4,5	3,3	58	11	24	90°	1235600400
5	5,5	4,2	66	13	28	90°	1235600500
6	6,6	5	70	16	31	90°	1235600600
8	9	6,8	84	20	40	90°	1235600800

ØM	ØD h8	Ød ±0,05	L	l1	l2	a ±1°	Art. No.
10	11	8,5	95	24	47	90°	1235601000
12	14	10,2	107	29	54	90°	1235601200
14	16	12	115	32	56	90°	1235601400
16	18	14	135	34	60	90°	1235601600

123 567**Kernloch-Kurzstufenbohrer HSS-E05+X.Cut 90°
HSS-E05 Thread Hole Step Drills+X.Cut 90°**

- Für Gewindekernlöcher (DIN 336-1)
- Hohe Rundlaufgenauigkeit
- Fluchtgenaues Bohren und Senken
- Senkwinkel 90°
- Oberfläche X5.Cut beschichtet
- For thread holes (DIN 336-1)
- High concentricity
- Drilling, chamfering in one operation
- Chamfer angle 90°
- With X5.Cut coating

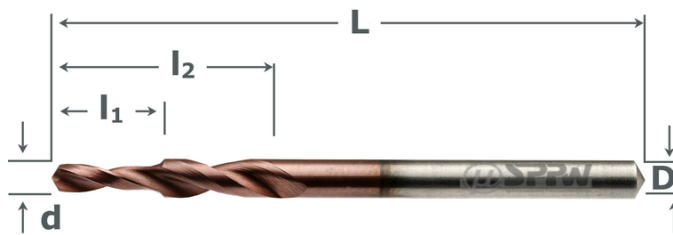

HSS E05	X Cut
90°	ZYL



ØM	ØD h8	Ød ±0,05	L	l1	l2	a ±1°	Art. No.
3	3,4	2,5	52	8	20	90°	1235670300
4	4,5	3,3	58	11	24	90°	1235670400
5	5,5	4,2	66	13	28	90°	1235670500
6	6,6	5	70	16	31	90°	1235670600
8	9	6,8	84	20	40	90°	1235670800

ØM	ØD h8	Ød ±0,05	L	l1	l2	a ±1°	Art. No.
10	11	8,5	95	24	47	90°	1235671000
12	14	10,2	107	29	54	90°	1235671200
14	16	12	115	32	56	90°	1235671400
16	18	14	135	34	60	90°	1235671600

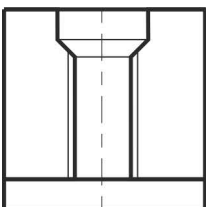
— INFO —

Einbringen von Senkung und Bohrung in einem Arbeitsgang mit hoher Fluchtgenauigkeit. Durch hohe Zentriergenauigkeit besonders für NC-Maschinen geeignet. Für Gewindekernlöcher mit Fase 90° nach DIN 336-1.

Chamfering and drilling in one operation with high alignment accuracy. Particularly suitable for NC machines due to high centering accuracy. For threaded core holes with chamfer 90° according to DIN 336-1.

123 400**Kurzstufenbohrer HSS-E05 90°
HSS-E05 Step Drills 90°**

- Schraubendurchgangslöcher DIN 273
- Senkungen nach DIN 74
- Fluchtgenaues Bohren und Senken
- Ausführung fein, Senkwinkel 90°
- Oberfläche blank

- For through holes (DIN 273)
- For screws with chamfer 90°
- Drilling, chamfering in one operation
- High concentricity
- Bright finish



ØM	ØD	Ød	Ød2	L	l1	a	Art. No.	ØM	ØD	Ød	Ød2	L	l1	a	Art. No.
	h9	±0,05	h9	±1	1	±1°			h9	±0,05	h9	±1	1	±1°	
2	4,6	2,2	4,6	45	6	90°	1234000200	5	10,4	5,3	10,4	55	13	90°	1234000500
2,5	5,7	2,7	5,7	45	7	90°	1234000250	6	12,4	6,4	12,4	63	15	90°	1234000600
3	6,5	3,2	6,5	45	9	90°	1234000300	8	16,4	8,4	12,5	100	19	90°	1234000800
3,5	7,6	3,7	7,6	50	10	90°	1234000350	10	20,4	10,5	12,5	110	23	90°	1234001000
4	8,6	4,3	8,6	50	11	90°	1234000400	12	25	13	12,5	120	28	90°	1234001200

123 407**Kurzstufenbohrer HSS-E05+X.Cut 90°
HSS-E05 Step Drills+X.Cut 90°**

- Schraubendurchgangslöcher DIN 273
- Senkungen nach DIN 74
- Fluchtgenaues Bohren und Senken
- Ausführung fein, Senkwinkel 90°
- Oberfläche X5.Cut beschichtet

- For through holes (DIN 273)
- For screws with chamfer 90°
- Drilling, chamfering in one operation
- High concentricity
- With X5.Cut coating

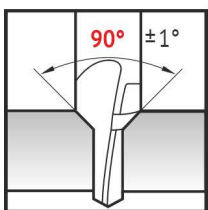

ØM	ØD	Ød	Ød2	L	l1	a	Art. No.	ØM	ØD	Ød	Ød2	L	l1	a	Art. No.
	h9	±0,05	h9	±1	1	±1°			h9	±0,05	h9	±1	1	±1°	
2	4,6	2,2	4,6	45	6	90°	1234070200	5	10,4	5,3	10,4	55	13	90°	1234070500
2,5	5,7	2,7	5,7	45	7	90°	1234070250	6	12,4	6,4	12,4	63	15	90°	1234070600
3	6,5	3,2	6,5	45	9	90°	1234070300	8	16,4	8,4	12,5	100	19	90°	1234070800
3,5	7,6	3,7	7,6	50	10	90°	1234070350	10	20,4	10,5	12,5	110	23	90°	1234071000
4	8,6	4,3	8,6	50	11	90°	1234070400	12	25	13	12,5	120	28	90°	1234071200

— INFO

Besonders stabile Ausführung für hohe Fluchtgenauigkeit. Enge Rundlauf- und Winkeltoleranzen. Durch hohe Zentriergenauigkeit auch für NC-Maschinen geeignet. Für Durchgangslöcher nach ISO 273 und Schrauben nach ISO 2009, 2010, 7046, 7047.

Particularly rigid design for high alignment accuracy. Tight concentricity and angular tolerances. Also suitable for NC machines due to high centering accuracy. Through holes according to ISO 273 and screws according to ISO 2009, 2010, 7046, 7047.

123 430

Stufenbohrer HSS-E05 90° mit langer Bohrstufe HSS-E05 Step Drills 90° with Long Pilot Drill



- Mit langer Bohrstufe für Profilmaterial
- Senkwinkel 90° für Senkung DIN 74
- Fluchtgenaues Bohren und Senken
- Oberfläche blank
- With long pilot drill suited for profiles
- For screws DIN 74 with chamfer 90°
- High concentricity
- Bright finish

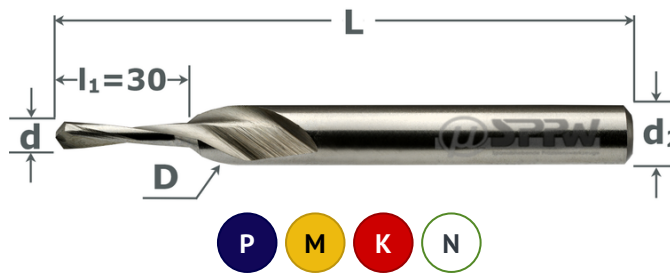

HSS E05	blank
90°	ZYL
L lang	

ØM	ØD h9	Ød ±0,05	Ød2 h9	L	l1	a ±1°	Art. No.	ØM	ØD h9	Ød ±0,05	Ød2 h9	L	l1	a ±1°	Art. No.
4	8,6	4,3	8,6	110	30	90°	1234300400	8	16,4	8,4	12,5	110	30	90°	1234300800
5	10,4	5,3	10,4	110	30	90°	1234300500	10	20,4	10,5	12,5	110	30	90°	1234301000
6	12,4	6,4	12,4	110	30	90°	1234300600								

123 437

Stufenbohrer HSS-E05+X.Cut 90° mit langer Bohrstufe HSS-E05 Step Drills+X.Cut 90° with Long Pilot Drill



- Mit langer Bohrstufe für Profilmaterial
- Senkwinkel 90° für Senkungen DIN 74
- Fluchtgenaues Bohren und Senken
- Oberfläche X5.Cut beschichtet
- With long pilot drill suited for profiles
- For screws DIN 74 with chamfer 90°
- High concentricity
- With X5.Cut coating

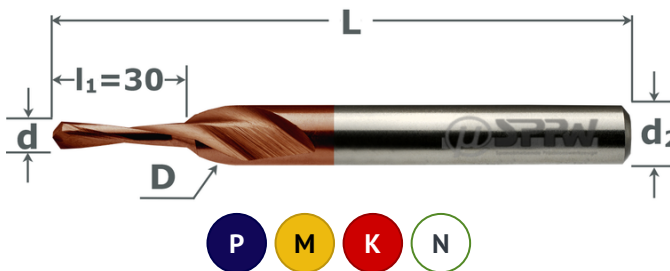

HSS E05	X Cut
90°	ZYL
L lang	

ØM	ØD h9	Ød ±0,05	Ød2 h9	L	l1	Art. No.	ØM	ØD h9	Ød ±0,05	Ød2 h9	L	l1	Art. No.
4	8,6	4,3	8,6	110	30	1234370400	8	16,4	8,4	12,5	110	30	1234370800
5	10,4	5,3	10,4	110	30	1234370500	10	20,4	10,5	12,5	110	30	1234371000
6	12,4	6,4	12,4	110	30	1234370600							

— INFO —

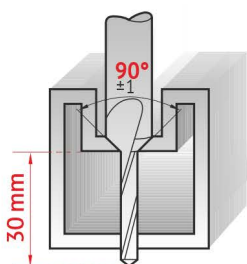

Stufenbohrer mit langer Bohrstufe

Mit Bohrerlänge 30mm. Speziell ausgelegt, um Aluminiumprofile in einem Arbeitsgang zu durchbohren und gleichzeitig die 90° Senkung für den Schraubenkopf einzubringen.

Step Drill with Long Drilling Step

With drilling length 30mm. Specially designed to drill through aluminum profiles in one operation and simultaneously make the 90° countersink for the screw head.

123 410**Kurzstufenbohrer HSS-E05 180°
HSS-E05 Step Drills 180°**

- Schraubendurchgangslöcher DIN 273
 - Senkungen nach DIN 74
 - Fluchtgenaues Bohren und Senken
 - Ausführung fein, Senkwinkel 180°
 - Oberfläche blank
- For through holes DIN 273
 - For screws with chamfer 180°
 - Drilling, chamfering in one operation
 - High concentricity
 - Bright finish

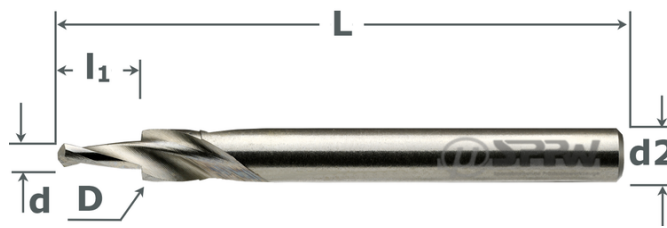

ØM	ØD	Ød	Ød2	L	l1	a	Art. No.
	h9	±0,05	h9	±1	1	±1°	
2	4,3	2,4	4,3	45	6	180°	1234100200
2,5	5	2,9	5	45	7	180°	1234100250
3	6	3,4	6	45	9	180°	1234100300
4	8	4,5	8	50	11	180°	1234100400
5	10	5,5	10	55	13	180°	1234100500

ØM	ØD	Ød	Ød2	L	l1	a	Art. No.
	h9	±0,05	h9	±1	1	±1°	
6	11	6,6	11	63	15	180°	1234100600
8	15	9	12,5	100	19	180°	1234100800
10	18	11	12,5	110	23	180°	1234101000
12	20	14	12,5	110	28	180°	1234101200
14	24	16	12,5	120	34	180°	1234101400

123 417**Kurzstufenbohrer HSS-E05+X.Cut 180°
HSS-E05 Step Drills+X.Cut 180°**

- Schraubendurchgangslöcher DIN 273
 - Senkungen nach DIN 74
 - Fluchtgenaues Bohren und Senken
 - Ausführung fein, Senkwinkel 180°
 - Oberfläche X5.Cut beschichtet
- For through holes DIN 273
 - For screws with chamfer 180°
 - Drilling, chamfering in one operation
 - High concentricity
 - With X5.Cut coating

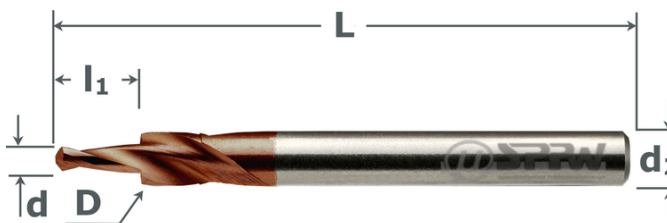

ØM	ØD	Ød	Ød2	L	l1	a	Art. No.
	h9	±0,05	h9	±1	1	±1°	
2	4,3	2,4	4,3	45	6	180°	1234170200
2,5	5	2,9	5	45	7	180°	1234170250
3	6	3,4	6	45	9	180°	1234170300
4	8	4,5	8	50	11	180°	1234170400
5	10	5,5	10	55	13	180°	1234170500

ØM	ØD	Ød	Ød2	L	l1	a	Art. No.
	h9	±0,05	h9	±1	1	±1°	
6	11	6,6	11	63	15	180°	1234170600
8	15	9	12,5	100	19	180°	1234170800
10	18	11	12,5	110	23	180°	1234171000
12	20	14	12,5	110	28	180°	1234171200
14	24	16	12,5	120	34	180°	1234171400

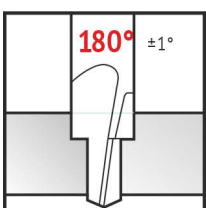
— INFO —

Besonders stabile Ausführung für hohe Fluchtgenauigkeit. Enge Rundlauf- und Winkeltoleranzen. Durch hohe Zentriergenauigkeit auch für NC-Maschinen geeignet. Für Durchgangslöcher nach ISO 273 und Senkungen nach DIN 74-2 H, J, K - mittel. Für Zylinderkopfschrauben ISO 1207.

Particularly rigid design for high alignment accuracy. Tight concentricity and angular tolerances. Also suitable for NC machines due to high centering accuracy. Through holes according to ISO 273 and counterbores according to DIN 74-2 H, J, K - medium. For cylinder head screws ISO 1207.



Spanabhebende Präzisionswerkzeuge

[DE] **Bohren**

[EN] **Drilling**

passion for precision

[Leidenschaft für Präzision]

D

Kleinst- und Microbohrer VHM

Carbide Miniature and Micro Drills

Art.No./Page

● ● ● ● ● ● ●		VHM	blank	DIN 1899	Typ N	118°	ZYL	611 121 Seite D 1
● ● ● ● ● ● ●		VHM	poliert	micro N	130°	DIN 6535HA	1xØ	761 821 Seite D 1
● ● ● ● ● ● ●		VHM	poliert	micro N	130°	DIN 6535HA	3xØ 5/100	761 823 Seite D 2
● ● ● ● ● ● ●		VHM	poliert	micro N	130°	DIN 6535HA	5xØ 1/100	761 825 Seite D 3
● ● ● ● ● ● ●		VHM	X Cut	micro N	130°	DIN 6535HA	5xØ 5/100	761 827 Seite D 4
● ● ● ● ● ● ●		VHM	poliert	micro N	130°	DIN 6535HA	8xØ 1/100	761 828 Seite D 5
● ● ● ● ● ● ●		VHM	poliert	130°	DIN 6535HA	micro 12xØ	5/100	761 832 Seite D 6
● ● ● ● ● ● ●		VHM	poliert	130°	DIN 6535HA	micro 15xØ	IK cool	761 835 Seite D 6
● ● ● ● ● ● ●		VHM	X Cut	mini N	140°	DIN 6535HA	5xØ IK cool	761 531 Seite D 7
● ● ● ● ● ● ●		VHM	X Cut	mini N	140°	DIN 6535HA	8xØ IK cool	761 631 Seite D 7
● ● ● ● ● ● ●		VHM	X Cut	mini N	140°	DIN 6535HA	12xØ IK cool	761 731 Seite D 7

Hochleistungsbohrer VHM

Carbide HPC Drills

Art.No./Page

● ● ● ● ● ● ●		VHM	X Cut	DIN 6537K	Typ N	140°	DIN 6535HA	3xØ	761 230 Seite D 8
● ● ● ● ● ● ●		VHM	X Cut	DIN 6537K	Typ N	140°	DIN 6535HA	3xØ IK cool	761 330 Seite D 9
● ● ● ● ● ● ●		VHM	X Cut	DIN 6537L	Typ N	140°	DIN 6535HA	5xØ IK cool	761 530 Seite D 10
● ● ● ● ● ● ●		VHM	X Cut	Typ N	140°	DIN 6535HA	8xØ IK cool	761 630 Seite D 11	
● ● ● ● ● ● ●		VHM	X Cut	Typ N	140°	DIN 6535HA	12xØ IK cool	761 730 Seite D 11	
● ● ● ● ● ● ●		VHM	blank	DIN 1897	Typ N	118°	ZYL	611 120 Seite D 12	
● ● ● ● ● ● ●		VHM	blank	DIN 338	Typ N	118°	ZYL	611 110 Seite D 13	

Bohrer VHM für CFK/GFK

Carbide Drills for FRP

Art.No./Page

		VHM	poliert	AFRP Aramid	Sichel	DIN 6535HA	3xØ	731 180 Seite D 14
		VHM	Dia HC	z:3	DIN 6535HA	OAL 100	GFK CFK	731 170 HC Seite D 14
		HMP	blank	DIN 338	90°	ZYL	GFK CFK	659 231 Seite D 19

Hochleistungsbohrer VHM für besondere Anwendungen

Carbide HPC Drills for Special Applications

Art.No./Page

		VHM	Z Cut	DIN 6537L	Typ W	130°	DIN 6535HA	5xØ	IK cool	761 540 Seite D 15
		VHM	X Cut	DIN 6537K	Typ N	140°	DIN 6535HA	3xØ	65 HRC	761 232 Seite D 16

Spiralbohrer HM-Platte

Carbide Tipped Drills

Art.No./Page

		HMP	blank	DIN 8037	Typ N	118°	ZYL	659 220 Seite D 17	
		HMP	blank	DIN 8037	Typ H	118°	DIN 1809	60 HRC	659 221 Seite D 17
		HMP	blank	DIN 338	Typ N	118°	ZYL	659 230 Seite D 18	
		HMP	blank	DIN 340	Typ N	118°	ZYL	659 240 Seite D 20	
		HMP	blank	DIN 8041	Typ N	118°	MK MTS	3xØ	658 900 Seite D 21

Kleinstbohrer HSS-E05

HSS-E05 Miniature Drills

Art.No./Page













		HSS E05	blank	DIN 1899	Typ N	118°	ZYL	1/100	411 121 Seite D 22
		HSS E05	blank	DIN 338	Typ N	130°	ZYL	411 221 Seite D 23	
		HSS E05	X Cut	DIN 338	Typ N	130°	ZYL	411 227 Seite D 23	

Spiralbohrer HSS-E05

HSS-E05 Drills

Art.No./Page





		HSS E05	blank	DIN 1897	Typ ZX	130°	ZYL	411 120 Seite D 24
		HSS E05	X Cut	DIN 1897	Typ ZX	130°	ZYL	411 127 Seite D 25
		HSS E05	X Cut	DIN 1897	135°	ZYL	Hardox	411 155 Seite D 26

●					●	○		HSS E05	blank	DIN 338	Typ ZX	130°	ZYL	411 140 Seite D 27
●	●	○						HSS E05	X Cut	DIN 338	Typ ZX	130°	ZYL	411 147 Seite D 28
●					●	○		HSS E05	blank	DIN 340	Typ ZX	130°	ZYL	411 180 Seite D 29
●	●							HSS E05	blank	DIN 338	Typ VA	130°	ZYL	411 111 Seite D 30
●	●	○						HSS E05	X Cut	DIN 338	Typ VA	130°	ZYL	411 117 Seite D 31
●	●				●			HSS E05	blank	Typ ZX	130°	ZYL	XL	411 280 Seite D 32
●	●				●			HSS E05	blank	Typ ZX	130°	ZYL	XL 160	411 290 Seite D 32
●	●				●			HSS E05	blank	Typ ZX	130°	ZYL	XL 200	411 300 Seite D 32
●	●				●			HSS E05	blank	Typ ZX	130°	ZYL	XL 250	411 310 Seite D 32
●	●				●			HSS E05	blank	Typ ZX	130°	ZYL	XL 315	411 320 Seite D 33
●	●				●			HSS E05	blank	Typ ZX	130°	ZYL	XL 400	411 330 Seite D 33
●	●				●			HSS E05	blank	Typ ZX	130°	ZYL	XL 500	411 340 Seite D 33

Spiralbohrer HSS

HSS Drills

Art.No./Page

●	●				○			HSS	blank	DIN 338	Typ N	118°	ZYL	5xØ	111 103 Seite D 34
●	●				○			HSS	C Cut	DIN 338	Typ N	135°	ZYL	5xØ	111 108 Seite D 35
●	●				○			HSS	blank	DIN 340	Typ N	118°	ZYL		111 130 Seite D 36
●	●				○			HSS	blank	DIN 338	Typ N	118°	ZYL	LH links	111 150 Seite D 37
●	●				○			HSS	VAP	DIN 345	Typ N	118°	MK MTS	5xØ	111 500 Seite D 38

611 121

Kleinstbohrer VHM DIN 1899 1/100-steigend Carbide Miniature Drills DIN 1899 1/100 increments



- Breiter Anwendungsbereich
- 4-Flächen-Anschliff
- Verstärkter Schaft ähnl. DIN 1899
- Oberfläche blank
- △ Verpackungseinheit 10 Stück

- Broad field of application
- 4 facet grinding
- Reinforced shank sim. DIN 1899
- Bright finish
- △ Packaging unit 10 pieces

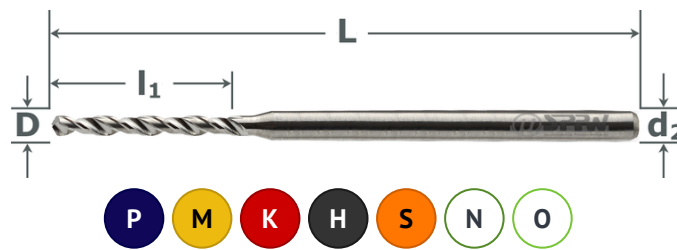

VHM	blank
DIN 1899	Typ N
118°	ZYL

ØD h6	Ød2 h6	L	l1	Art. No.	ØD h6	Ød2 h6	L	l1	Art. No.
0,15-0,19	1	30	1	611121xxxx	0,75-0,79	1	30	8	611121xxxx
0,20-0,25	1	30	2	611121xxxx	0,80-0,94	1,5	30	8	611121xxxx
0,26-0,30	1	30	2,5	611121xxxx	0,95-1,04	1,5	30	10	611121xxxx
0,31-0,34	1	30	3	611121xxxx	1,05-1,14	1,5	30	10	611121xxxx
0,35-0,44	1	30	4	611121xxxx	1,15-1,20	1,5	30	12	611121xxxx
0,45-0,54	1	30	6	611121xxxx	1,21-1,49	1,5	30	12	611121xxxx
0,55-0,64	1	30	6	611121xxxx	1,50-1,99	2	30	12	611121xxxx
0,65-0,74	1	30	7	611121xxxx	2	2,5	30	12	6111210200

761 821

Micro-Pilotbohrer VHM 1xØ Carbide Micro Pilot Drills 1xØ



- Breiter Anwendungsbereich
- 4-Flächen-Anschliff
- Verstärkter Schaft Ø3 h5
- Oberfläche blank

- Broad field of application
- 4 facet grinding
- Reinforced shank Ø3 h5
- Bright finish

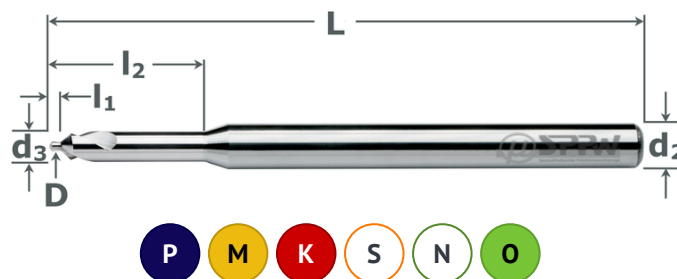

VHM	poliert
micro N	130°
DIN 6535HA	1xØ

ØD h6	Ød2 h5	L	l1	Art. No.	ØD h6	Ød2 h5	L	l1	Art. No.
0,10	3	39	0,1	7618210010	0,40	3	39	0,4	7618210040
0,15	3	39	0,15	7618210015	0,50	3	39	0,5	7618210050
0,20	3	39	0,2	7618210020	0,60	3	39	0,6	7618210060
0,25	3	39	0,25	7618210025	0,80	3	39	0,8	7618210080
0,30	3	39	0,3	7618210030	1,00	3	39	1	7618210100

761 823**Micro-Hochleistungsbohrer VHM 3xØ
Carbide Miniature Drills 3xØ**

- Breiter Anwendungsbereich
- 4-Flächen-Anschliff
- Verstärkter Schaft Ø3 h5
- Oberfläche blank
- Broad field of application
- 4 facet grinding
- Reinforced shank Ø3 h5
- Bright finish

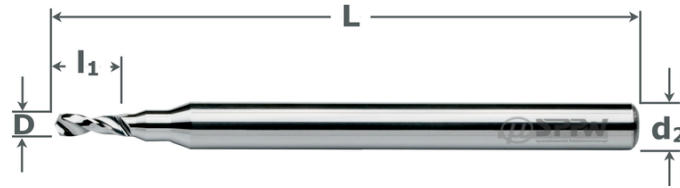

VHM	poliert
micro N	130°
DIN 6535HA	3xØ
5/100	

D

ØD h6	Ød2 h5	L	l1	Art. No.
0,10	3	39	0,3	7618230010
0,15	3	39	0,45	7618230015
0,20	3	39	0,6	7618230020
0,25	3	39	0,75	7618230025
0,30	3	39	0,9	7618230030
0,35	3	39	1,05	7618230035
0,40	3	39	1,2	7618230040
0,45	3	39	1,35	7618230045
0,50	3	39	1,5	7618230050
0,55	3	39	1,8	7618230055
0,60	3	39	1,8	7618230060
0,65	3	39	2,1	7618230065
0,70	3	39	2,1	7618230070
0,75	3	39	2,4	7618230075
0,80	3	39	2,4	7618230080
0,85	3	39	2,7	7618230085
0,90	3	39	2,7	7618230090
0,95	3	39	3	7618230095
1,00	3	39	3	7618230100
1,05	3	39	3,3	7618230105
1,10	3	39	3,3	7618230110
1,15	3	39	3,6	7618230115
1,20	3	39	3,6	7618230120
1,25	3	39	3,9	7618230125
1,30	3	39	3,9	7618230130
1,35	3	39	4,2	7618230135
1,40	3	39	4,2	7618230140
1,45	3	39	4,5	7618230145
1,50	3	39	4,5	7618230150
1,55	3	39	4,8	7618230155

ØD h6	Ød2 h5	L	l1	Art. No.
1,60	3	39	4,8	7618230160
1,65	3	39	5,1	7618230165
1,70	3	39	5,1	7618230170
1,75	3	39	5,4	7618230175
1,80	3	39	5,4	7618230180
1,85	3	39	5,7	7618230185
1,90	3	39	5,7	7618230190
1,95	3	39	6	7618230195
2,00	3	39	6	7618230200
2,05	3	39	6,3	7618230205
2,10	3	39	6,3	7618230210
2,15	3	39	6,6	7618230215
2,20	3	39	6,6	7618230220
2,25	3	39	6,9	7618230225
2,30	3	39	6,9	7618230230
2,35	3	39	7,2	7618230235
2,40	3	39	7,2	7618230240
2,45	3	39	7,5	7618230245
2,50	3	39	7,5	7618230250
2,55	3	39	7,8	7618230255
2,60	3	39	7,8	7618230260
2,65	3	39	8,1	7618230265
2,70	3	39	8,1	7618230270
2,75	3	39	8,4	7618230275
2,80	3	39	8,4	7618230280
2,85	3	39	8,7	7618230285
2,90	3	39	8,7	7618230290
2,95	3	39	9	7618230295
3,00	3	39	9	7618230300

761 825

Micro-Hochleistungsbohrer VHM 1/100-steigend 5xØ
Carbide Miniature Drills 5xØ 1/100 increments



- Breiter Anwendungsbereich
- 4-Flächen-Anschliff
- Verstärkter Schaft Ø3 h5
- Oberfläche blank
- Broad field of application
- 4 facet grinding
- Reinforced shank Ø3 h5
- Bright finish

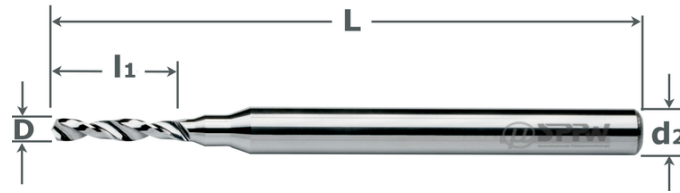

VHM	poliert
micro N	130°
DIN 6535HA	5xØ
1/100	



ØD h6	Ød2 h5	L	l1	Art. No.	ØD h6	Ød2 h5	L	l1	Art. No.
0,10	3	39	0,5	7618250010	1,21-1,30	3	39	6,5	761825xxxx
0,11-0,12	3	39	0,6	761825xxxx	1,31-1,40	3	39	7	761825xxxx
0,13-0,14	3	39	0,7	761825xxxx	1,41-1,49	3	39	7,5	761825xxxx
0,15-0,16	3	39	0,8	761825xxxx	1,50	3	39	7,5	7618250150
0,17-0,18	3	39	0,9	761825xxxx	1,51-1,60	3	39	8	761825xxxx
0,19-0,20	3	39	1	761825xxxx	1,61-1,70	3	39	8,5	761825xxxx
0,21-0,25	3	39	1,25	761825xxxx	1,71-1,80	3	39	9	761825xxxx
0,26-0,30	3	39	1,5	761825xxxx	1,81-1,90	3	39	9,5	761825xxxx
0,31-0,35	3	39	1,75	761825xxxx	1,91-1,99	3	39	10	761825xxxx
0,36-0,40	3	39	2	761825xxxx	2,00	3	39	10	7618250200
0,41-0,45	3	39	2,25	761825xxxx	2,01-2,10	3	39	10,5	761825xxxx
0,46-0,49	3	39	2,5	761825xxxx	2,11-2,20	3	39	11	761825xxxx
0,50	3	39	2,5	7618250050	2,21-2,30	3	39	11,5	761825xxxx
0,51-0,60	3	39	3	761825xxxx	2,31-2,40	3	39	12	761825xxxx
0,61-0,70	3	39	3,5	761825xxxx	2,41-2,50	3	39	12,5	761825xxxx
0,71-0,80	3	39	4	761825xxxx	2,51-2,60	3	39	13	761825xxxx
0,81-0,90	3	39	4,5	761825xxxx	2,61-2,70	3	39	13,5	761825xxxx
0,91-0,99	3	39	5	761825xxxx	2,71-2,80	3	39	14	761825xxxx
1,00	3	39	5	7618250100	2,81-2,90	3	39	14,5	761825xxxx
1,01-1,10	3	39	5,5	761825xxxx	2,91-2,99	3	39	15	761825xxxx
1,11-1,20	3	39	6	761825xxxx	3,00	3	39	15	7618250300

— INFO —

Verpackungseinheit = 1 | Packaging Unit = 1

Alle Micro-Spiralbohrer der 7618er-Serie werden einzeln verpackt geliefert.
All 7618-series micro drills are supplied individually packed.



761 827**Micro-Hochleistungsbohrer VHM+X.Cut 5xØ
Carbide Miniature Drills+X.Cut 5xØ**

- Breiter Anwendungsbereich
- 4-Flächen-Anschliff
- Verstärkter Schaft Ø3 h5
- Oberfläche X.Cut beschichtet
- Broad field of application
- 4 facet grinding
- Reinforced shank Ø3 h5
- With X.Cut coating

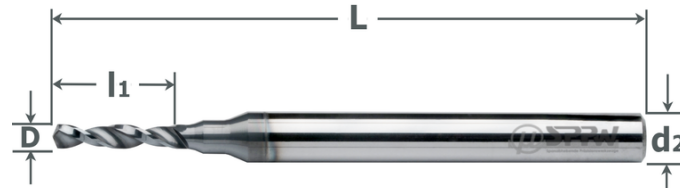

VHM	X Cut
micro N	130°
DIN 6535HA	5xØ
5/100	

ØD h6	Ød2 h5	L	l1	Art. No.
0,10	3	39	0,5	7618270010
0,15	3	39	0,8	7618270015
0,20	3	39	1	7618270020
0,25	3	39	1,25	7618270025
0,30	3	39	1,5	7618270030
0,35	3	39	1,75	7618270035
0,40	3	39	2	7618270040
0,45	3	39	2,25	7618270045
0,50	3	39	2,5	7618270050
0,55	3	39	3	7618270055
0,60	3	39	3	7618270060
0,65	3	39	3,5	7618270065
0,70	3	39	3,5	7618270070
0,75	3	39	4	7618270075
0,80	3	39	4	7618270080
0,85	3	39	4,5	7618270085
0,90	3	39	4,5	7618270090
0,95	3	39	5	7618270095
1,00	3	39	5	7618270100
1,05	3	39	5,5	7618270105
1,10	3	39	5,5	7618270110
1,15	3	39	6	7618270115
1,20	3	39	6	7618270120
1,25	3	39	6,5	7618270125
1,30	3	39	6,5	7618270130
1,35	3	39	7	7618270135
1,40	3	39	7	7618270140
1,45	3	39	7,5	7618270145
1,50	3	39	7,5	7618270150
1,55	3	39	8	7618270155

ØD h6	Ød2 h5	L	l1	Art. No.
1,60	3	39	8	7618270160
1,65	3	39	8,5	7618270165
1,70	3	39	8,5	7618270170
1,75	3	39	9	7618270175
1,80	3	39	9	7618270180
1,85	3	39	9,5	7618270185
1,90	3	39	9,5	7618270190
1,95	3	39	10	7618270195
2,00	3	39	10	7618270200
2,05	3	39	10,5	7618270205
2,10	3	39	10,5	7618270210
2,15	3	39	11	7618270215
2,20	3	39	11	7618270220
2,25	3	39	11,5	7618270225
2,30	3	39	11,5	7618270230
2,35	3	39	12	7618270235
2,40	3	39	12	7618270240
2,45	3	39	12,5	7618270245
2,50	3	39	12,5	7618270250
2,55	3	39	13	7618270255
2,60	3	39	13	7618270260
2,65	3	39	13,5	7618270265
2,70	3	39	13,5	7618270270
2,75	3	39	14	7618270275
2,80	3	39	14	7618270280
2,85	3	39	14,5	7618270285
2,90	3	39	14,5	7618270290
2,95	3	39	15	7618270295
3,00	3	39	15	7618270300

761 828

Micro-Hochleistungsbohrer VHM 1/100-steigend 8xØ
Carbide Miniature Drills 8xØ 1/100 increments



- Breiter Anwendungsbereich
- 4-Flächen-Anschliff
- Verstärkter Schaft Ø3 h5
- Oberfläche blank
- Broad field of application
- 4 facet grinding
- Reinforced shank Ø3 h5
- Bright finish

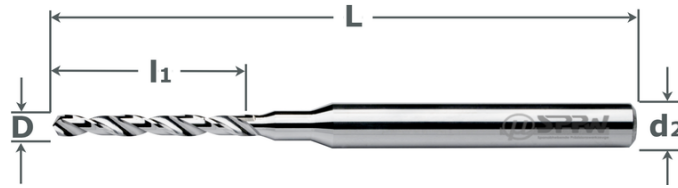

VHM	poliert
micro N	130°
DIN 6535HA	8xØ
1/100	



ØD h6	Ød2 h5	L	l1	Art. No.	ØD h6	Ød2 h5	L	l1	Art. No.
0,10	3	39	0,8	7618280010	0,81-0,90	3	39	7,2	761828xxxx
0,11-0,12	3	39	1	761828xxxx	0,91-0,99	3	39	8	761828xxxx
0,13-0,14	3	39	1,2	761828xxxx	1,00	3	39	8	7618280100
0,15-0,16	3	39	1,3	761828xxxx	1,01-1,10	3	39	8,8	761828xxxx
0,17-0,18	3	39	1,5	761828xxxx	1,11-1,20	3	39	9,6	761828xxxx
0,19	3	39	1,6	7618280019	1,21-1,30	3	39	10,4	761828xxxx
0,20	3	39	1,6	7618280020	1,31-1,40	3	39	11,2	761828xxxx
0,21-0,25	3	39	2	761828xxxx	1,41-1,49	3	39	12	761828xxxx
0,26-0,30	3	39	2,4	761828xxxx	1,50	3	39	12	7618280150
0,31-0,35	3	39	2,8	761828xxxx	1,51-1,60	3	39	12,8	761828xxxx
0,36-0,40	3	39	3,2	761828xxxx	1,61-1,70	3	39	13,6	761828xxxx
0,41-0,45	3	39	3,6	761828xxxx	1,71-1,80	3	39	14,4	761828xxxx
0,46-0,59	3	39	4	761828xxxx	1,81-1,90	3	39	15,2	761828xxxx
0,50	3	39	4	7618280050	1,91-1,99	3	39	16	761828xxxx
0,51-0,60	3	39	4,8	761828xxxx	2,00	3	39	16	7618280200
0,61-0,70	3	39	5,6	761828xxxx	2,01-2,05	3	39	16,8	761828xxxx
0,71-0,80	3	39	6,4	761828xxxx					

— INFO —

Höhere Stabilität

Für besseres Schwingungsverhalten und werden unsere Micro-Spiralbohrer der 7618er-Serie bis Ø1,5 mit einem gestuften Schaftübergang gefertigt.

Higher Rigidity

For optimized vibration characteristics our 7618-series micro-drills up to diameter 1,5 mm are manufactured with a stepped connection to the shank.

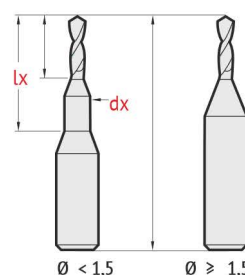

761 832**Micro-Hochleistungsbohrer VHM 12xØ**
Carbide Miniature Drills 12xØ

- Breiter Anwendungsbereich
- 4-Flächen-Anschliff
- Verstärkter Schaft Ø3 h5
- Oberfläche blank
- Broad field of application
- 4 facet grinding
- Reinforced shank Ø3 h5
- Bright finish

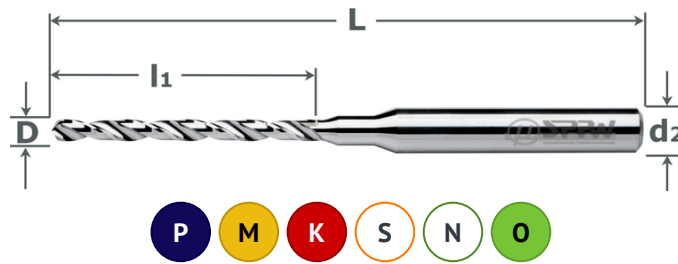

VHM	poliert
130°	DIN 6535HA
micro 12xØ	5/100

D

ØD h6	Ød2 h5	L	l1	Art. No.	ØD h6	Ød2 h5	L	l1	Art. No.	ØD h6	Ød2 h5	L	l1	Art. No.
0,30	3	39	4,0	7618320030	0,90	3	39	11,9	7618320090	1,50	3	60	19,8	7618320150
0,35	3	39	4,6	7618320035	0,95	3	39	13,2	7618320095	1,55	3	60	21,1	7618320155
0,40	3	39	5,3	7618320040	1,00	3	39	13,2	7618320100	1,60	3	60	21,1	7618320160
0,45	3	39	5,9	7618320045	1,05	3	39	14,5	7618320105	1,65	3	60	22,4	7618320165
0,50	3	39	6,6	7618320050	1,10	3	39	14,5	7618320110	1,70	3	60	22,4	7618320170
0,55	3	39	7,9	7618320055	1,15	3	39	15,8	7618320115	1,75	3	60	23,8	7618320175
0,60	3	39	7,9	7618320060	1,20	3	39	15,8	7618320120	1,80	3	60	23,8	7618320180
0,65	3	39	9,2	7618320065	1,25	3	39	17,2	7618320125	1,85	3	60	25,4	7618320185
0,70	3	39	9,2	7618320070	1,30	3	60	17,2	7618320130	1,90	3	60	25,4	7618320190
0,75	3	39	10,6	7618320075	1,35	3	60	18,5	7618320135	1,95	3	60	26,4	7618320195
0,80	3	39	10,6	7618320080	1,40	3	60	18,5	7618320140	2,00	3	60	26,4	7618320200
0,85	3	39	11,9	7618320085	1,45	3	60	19,8	7618320145	2,05	3	60	27,1	7618320205

761 835**Micro-Hochleistungs-Kühlkanalbohrer VHM 15xØ**
Carbide Miniature Drills with Internal Cooling 15xØ

- Breiter Anwendungsbereich
- 4-Flächen-Anschliff
- Verstärkter Schaft Ø3 h5
- Oberfläche blank
- Broad field of application
- 4 facet grinding
- Reinforced shank Ø3 h5
- Bright finish

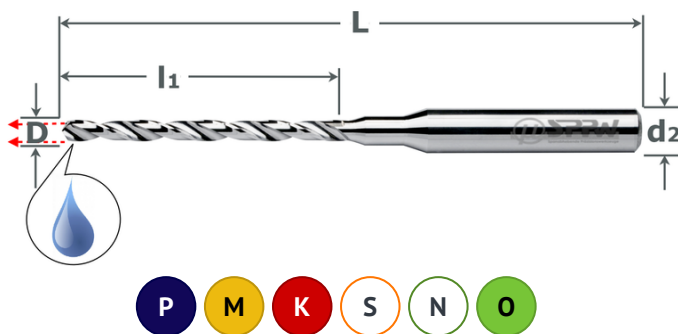

VHM	poliert
130°	DIN 6535HA
micro 15xØ	IK cool

ØD h6	Ød2 h5	L	l1	Art. No.	ØD h6	Ød2 h5	L	l1	Art. No.	ØD h6	Ød2 h5	L	l1	Art. No.
1,00	3	75	16,5	7618350100	1,40	3	75	23,1	7618350140	1,80	3	95	29,7	7618350180
1,05	3	75	17,3	7618350105	1,45	3	75	23,9	7618350145	1,85	3	95	30,5	7618350185
1,10	3	75	18,2	7618350110	1,50	3	75	24,8	7618350150	1,90	3	95	31,4	7618350190
1,15	3	75	19,0	7618350115	1,55	3	95	25,6	7618350155	1,95	3	95	32,2	7618350195
1,20	3	75	19,8	7618350120	1,60	3	95	26,4	7618350160	2,00	3	95	33,0	7618350200
1,25	3	75	20,6	7618350125	1,65	3	95	27,2	7618350165	2,05	3	95	33,8	7618350205
1,30	3	75	21,5	7618350130	1,70	3	95	28,1	7618350170					
1,35	3	75	22,3	7618350135	1,75	3	95	28,9	7618350175					

D 6



- Breiter Anwendungsbereich
- 4-Flächen-Anschliff
- Innenkühlung, Mindestdruck 80 bar
- Verstärkter Schaft Ø3 h6
- Oberfläche X.Cut beschichtet
- Broad field of application
- 4 facet grinding
- Internal cooling, minimum 80 bar
- Reinforced shank Ø3 h6
- With X.Cut coating

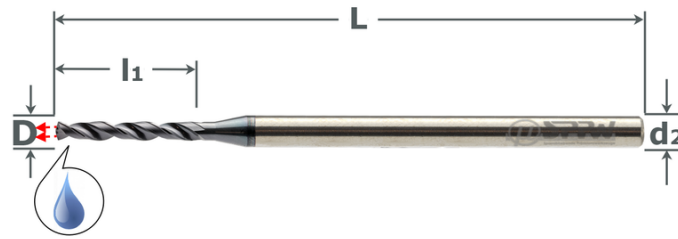

VHM	X Cut
mini N	140°
DIN 6535HA	5xØ
IK cool	

761531 - 5xØ

ØD m7	Ød2 h6	L	l1	Art. No.
1,0	3	55	8	7615310100
1,1-1,4	3	55	12	761531xxxx
1,5	3	55	12	7615310150
1,6-1,9	3	65	16	761531xxxx

ØD m7	Ød2 h6	L	l1	Art. No.
2,0	3	65	16	7615310200
2,1-2,4	3	74	20	761531xxxx
2,5	3	74	20	7615310250
2,6-2,9	3	81	23	761531xxxx

761631 - 8xØ

ØD m7	Ød2 h6	L	l1	Art. No.
1,0	3	55	11	7616310100
1,1-1,4	3	55	17	761631xxxx
1,5	3	55	17	7616310150
1,6-1,9	3	65	22	761631xxxx

ØD m7	Ød2 h6	L	l1	Art. No.
2,0	3	65	22	7616310200
2,1-2,4	3	74	28	761631xxxx
2,5	3	74	28	7616310250
2,6-2,9	3	81	32	761631xxxx

761731 - 12xØ

ØD m7	Ød2 h6	L	l1	Art. No.
1,0	3	55	15	7617310100
1,1-1,4	3	55	23	761731xxxx
1,5	3	55	23	7617310150
1,6-1,9	3	65	30	761731xxxx

ØD m7	Ød2 h6	L	l1	Art. No.
2,0	3	65	30	7617310200
2,1-2,4	3	74	38	761731xxxx
2,5	3	74	38	7617310250
2,6-2,9	3	81	44	761731xxxx

761 230**Hochleistungsbohrer VHM+X.Cut 3xØ**
Carbide High Performance Drills+X.Cut 3xØ

- Universeller Hochleistungsbohrer
- Kurze Späne, gute Spanabfuhr
- Oberfläche X.Cut beschichtet
- Universal high performance drill
- Short chipping, good chip transport
- With X.Cut coating

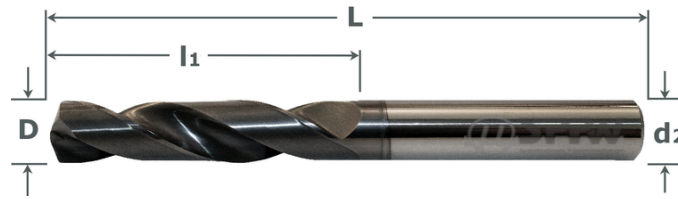

VHM	X Cut
DIN 6537K	Typ N
140°	DIN 6535HA
3xØ	

ØD m7	Ød2 h6	L	l1	Art. No.	ØD m7	Ød2 h6	L	l1	Art. No.
3	6	62	20	7612300300	12,5	14	107	60	7612301250
3,1-3,7	6	62	20	761230xxxx	12,8	14	107	60	7612301280
3,8-3,9	6	66	24	761230xxxx	13	14	107	60	7612301300
4	6	66	24	7612300400	13,5	14	107	60	7612301350
4,1-4,7	6	66	24	761230xxxx	13,8	14	107	60	7612301380
4,8-4,9	6	66	28	761230xxxx	14	14	107	60	7612301400
5	6	66	28	7612300500	14,5	16	115	65	7612301450
5,1-5,9	6	66	28	761230xxxx	14,8	16	115	65	7612301480
6	6	66	28	7612300600	15	16	115	65	7612301500
6,1-6,9	8	79	34	761230xxxx	15,5	16	115	65	7612301550
7	8	79	34	7612300700	15,8	16	115	65	7612301580
7,1-7,9	8	79	41	761230xxxx	16	16	115	65	7612301600
8	8	79	41	7612300800	16,5	18	123	73	7612301650
8,1-8,9	10	89	47	761230xxxx	16,8	18	123	73	7612301680
9	10	89	47	7612300900	17	18	123	73	7612301700
9,1-9,9	10	89	47	761230xxxx	17,5	18	123	73	7612301750
10	10	89	47	7612301000	17,8	18	123	73	7612301780
10,1-10,3	12	102	55	761230xxxx	18	18	123	73	7612301800
10,4-10,6	12	102	55	761230xxxx	18,5	20	131	79	7612301850
10,7-10,9	12	102	55	761230xxxx	19	20	131	79	7612301900
11	12	102	55	7612301100	19,5	20	131	79	7612301950
11,1-11,9	12	102	55	761230xxxx	19,8	20	131	79	7612301980
12	12	102	55	7612301200	20	20	131	79	7612302000
12,3	14	107	60	7612301230					

INFO**LU: Bohrtiefe | Drilling Depth**

Zur Berechnung der Bohrtiefe (LU) muss von der Spiralnutlänge (l1 | LCF) das 1,5-fache des Durchmessers (D) abgezogen werden.

To calculate the drilling depth (LU), 1.5 times the diameter (D) must be subtracted from the flute length (l1 | LCF).

$$LU = LCF - 1,5x D$$

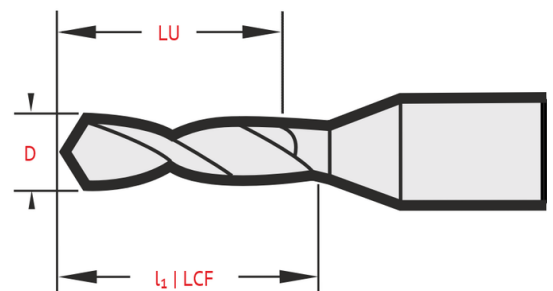

761 330

Hochleistungs-Kühlkanalbohrer VHM+X.Cut 3xØ Carbide High Performance Drills+X.Cut Internal Cooling 3xØ



- Universeller Hochleistungsbohrer
- Innenkühlung, Mindestdruck 30 bar
- Kurze Späne, gute Spanabfuhr
- Oberfläche X.Cut beschichtet
- Zwischenabmessungen auf Anfrage
- Universal high performance drill
- Internal cooling, minimum 30 bar
- Short chipping, good chip transport
- With X.Cut coating
- Intermediate sizes on request

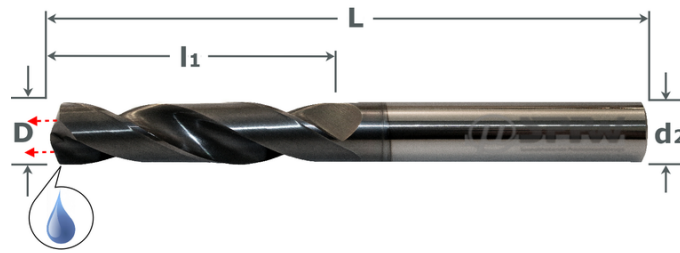

VHM	X Cut
DIN 6537K	Typ N
140°	DIN 6535HA
3xØ	IK cool

ØD m7	Ød2 h6	L	l1	Art. No.	ØD m7	Ød2 h6	L	l1	Art. No.
3	6	62	20	7613300300	12,8	14	107	60	7613301280
3,1-3,7	6	62	20	761330xxxx	13	14	107	60	7613301300
3,8-3,9	6	66	24	761330xxxx	13,5	14	107	60	7613301350
4	6	66	24	7613300400	13,8	14	107	60	7613301380
4,1-4,7	6	66	24	761330xxxx	14	14	107	60	7613301400
4,8-4,9	6	66	28	761330xxxx	14,5	16	115	65	7613301450
5	6	66	28	7613300500	14,8	16	115	65	7613301480
5,1-5,9	6	66	28	761330xxxx	15	16	115	65	7613301500
6	6	66	28	7613300600	15,5	16	115	65	7613301550
6,1-6,9	8	79	34	761330xxxx	15,8	16	115	65	7613301580
7	8	79	34	7613300700	16	16	115	65	7613301600
7,1-7,9	8	79	41	761330xxxx	16,5	18	123	73	7613301650
8	8	79	41	7613300800	16,8	18	123	73	7613301680
8,1-8,9	10	89	47	761330xxxx	17	18	123	73	7613301700
9	10	89	47	7613300900	17,5	18	123	73	7613301750
9,1-9,9	10	89	47	761330xxxx	17,8	18	123	73	7613301780
10	10	89	47	7613301000	18	18	123	73	7613301800
10,1-10,9	12	102	55	761330xxxx	18,5	20	131	79	7613301850
11	12	102	55	7613301100	19	20	131	79	7613301900
11,1-11,9	12	102	55	761330xxxx	19,5	20	131	79	7613301950
12	12	102	55	7613301200	19,8	20	131	79	7613301980
12,3	14	107	60	7613301230	20	20	131	79	7613302000
12,5	14	107	60	7613301250					



761 530

Hochleistungs-Kühlkanalbohrer VHM+X.Cut 5xØ Carbide High Performance Drills+X.Cut Internal Cooling 5xØ



- Universeller Hochleistungsbohrer
- Innenkühlung, Mindestdruck 30 bar
- Kurze Späne, gute Spanabfuhr
- Oberfläche X.Cut beschichtet
- Universal high performance drill
- Internal cooling, minimum 30 bar
- Short chipping, good chip transport
- With X.Cut coating

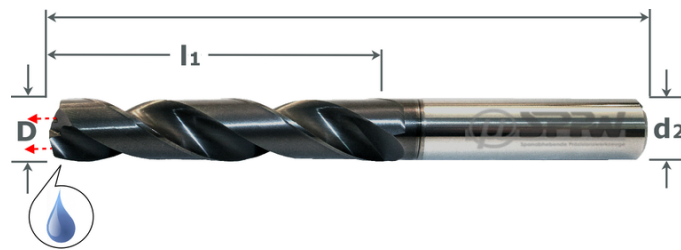

VHM	X Cut
DIN 6537L	Typ N
140°	DIN 6535HA
5xØ	IK cool

ØD m7	Ød2 h6	L	l1	Art. No.	ØD m7	Ød2 h6	L	l1	Art. No.
3	6	66	28	7615300300	12,2	14	124	77	7615301220
3,1-3,7	6	66	28	761530xxxx	12,3	14	124	77	7615301230
3,8-3,9	6	74	36	761530xxxx	12,5	14	124	77	7615301250
4	6	74	36	7615300400	12,8	14	124	77	7615301280
4,1-4,6	6	74	36	761530xxxx	13	14	124	77	7615301300
4,65	6	74	36	7615300465	13,5	14	124	77	7615301350
4,7	6	74	36	7615300470	13,8	14	124	77	7615301380
4,8-4,9	6	82	44	761530xxxx	14	14	124	77	7615301400
5	6	82	44	7615300500	14,5	16	133	83	7615301450
5,1-5,5	6	82	44	761530xxxx	14,8	16	133	83	7615301480
5,55	6	82	44	7615300555	15	16	133	83	7615301500
5,6-5,9	6	82	44	761530xxxx	15,5	16	133	83	7615301550
6	6	82	44	7615300600	15,8	16	133	83	7615301580
6,1-6,9	8	91	53	761530xxxx	16	16	133	83	7615301600
7	8	91	53	7615300700	16,5	18	143	93	7615301650
7,1-7,9	8	91	53	761530xxxx	16,8	18	143	93	7615301680
8	8	91	53	7615300800	17	18	143	93	7615301700
8,1-8,9	10	103	61	761530xxxx	17,5	18	143	93	7615301750
9	10	103	61	7615300900	17,8	18	143	93	7615301780
9,1-9,9	10	103	61	761530xxxx	18	18	143	93	7615301800
10	10	103	61	7615301000	18,5	20	153	101	7615301850
10,1-10,9	12	118	71	761530xxxx	19	20	153	101	7615301900
11	12	118	71	7615301100	19,5	20	153	101	7615301950
11,1-11,9	12	118	71	761530xxxx	20	20	153	101	7615302000
12	12	118	71	7615301200					

761 630

Hochleistungs-Kühlkanalbohrer VHM+X.Cut 8xØ
Carbide High Performance Drills+X.Cut Internal Cooling 8xØ



- Universeller Hochleistungsbohrer
- Innenkühlung, Mindestdruck 30 bar
- Kurze Späne, gute Spanabfuhr
- 4 Führungsfasen für höhere Präzision
- Oberfläche X.Cut beschichtet
- Universal high performance drill
- Internal cooling, minimum 30 bar
- Short chipping, good chip transport
- 4 guiding lands for higher precision
- With X.Cut coating

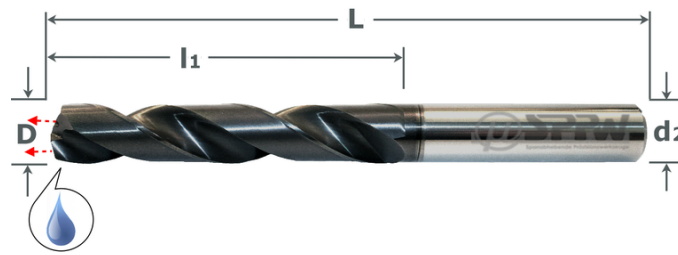

VHM	X Cut
Typ N	140°
DIN 6535HA	8xØ
IK cool	

761630 - 8xØ

ØD m7	Ød2 h6	L	l1	Art. No.	ØD m7	Ød2 h6	L	l1	Art. No.	ØD m7	Ød2 h6	L	l1	Art. No.
3	6	72	34	7616300300	5,5	6	95	57	7616300550	9,5	10	142	95	7616300950
3,3	6	72	34	7616300330	5,8	6	95	57	7616300580	9,8	10	142	95	7616300980
3,5	6	72	34	7616300350	6	6	95	57	7616300600	10	10	142	95	7616301000
3,7	6	72	34	7616300370	6,5	8	114	76	7616300650	10,2	12	162	114	7616301020
3,8	6	86	43	7616300380	6,8	8	114	76	7616300680	10,5	12	162	114	7616301050
4	6	86	43	7616300400	7	8	114	76	7616300700	10,8	12	162	114	7616301080
4,2	6	86	43	7616300420	7,5	8	114	76	7616300750	11	12	162	114	7616301100
4,5	6	86	43	7616300450	7,8	8	114	76	7616300780	11,5	12	162	114	7616301150
4,7	6	86	43	7616300470	8	8	114	76	7616300800	11,8	12	162	114	7616301180
4,8	6	95	57	7616300480	8,5	10	142	95	7616300850	12	12	162	114	7616301200
5	6	95	57	7616300500	9	10	142	95	7616300900					

761730 - 12xØ

ØD m7	Ød2 h6	L	l1	Art. No.	ØD m7	Ød2 h6	L	l1	Art. No.	ØD m7	Ød2 h6	L	l1	Art. No.
3	6	92	54	7617300300	6,8	8	146	108	7617300680	11	12	204	156	7617301100
3,3	6	92	54	7617300330	7	8	146	108	7617300700	11,5	12	204	156	7617301150
3,5	6	92	54	7617300350	7,5	8	146	108	7617300750	11,8	12	204	156	7617301180
3,7	6	92	54	7617300370	7,8	8	146	108	7617300780	12	12	204	156	7617301200
3,8	6	102	64	7617300380	8	8	146	108	7617300800	12,5	14	230	182	7617301250
4	6	102	64	7617300400	8,5	10	162	120	7617300850	12,8	14	230	182	7617301280
4,2	6	102	64	7617300420	8,8	10	162	120	7617300880	13	14	230	182	7617301300
4,5	6	102	64	7617300450	9	10	162	120	7617300900	13,5	14	230	182	7617301350
4,8	6	118	78	7617300480	9,5	10	162	120	7617300950	14	14	230	182	7617301400
5	6	118	78	7617300500	9,8	10	162	120	7617300980	14,5	16	260	208	7617301450
5,5	6	118	78	7617300550	10	10	162	120	7617301000	15	16	260	208	7617301500
5,8	6	118	78	7617300580	10,2	12	204	156	7617301020	15,5	16	260	208	7617301550
6	6	118	78	7617300600	10,5	12	204	156	7617301050	16	16	260	208	7617301600
6,5	8	146	108	7617300650	10,8	12	204	156	7617301080					



- Breiter Anwendungsbereich
- Stabile Ausführung für Bohrungen 3xØ
- Selbstzentrierender Anschliff
- Oberfläche blank

- Broad field of application
- Rigid version for drillings up to 3xØ
- Self centering 4 facet grinding
- Bright finish

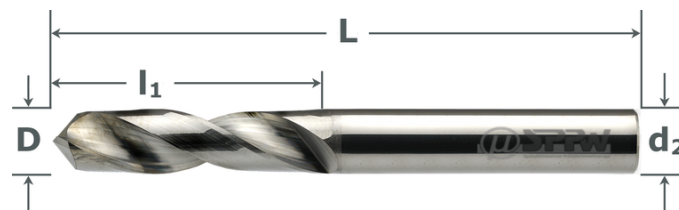

VHM	blank
DIN 1897	Typ N
118°	ZYL

ØD h6	L	l1	Art. No.	ØD h6	L	l1	Art. No.	ØD h6	L	l1	Art. No.
1,0	26	6	6111200100	4,5	58	24	6111200450	8,0	79	37	6111200800
1,1	28	7	6111200110	4,6	58	24	6111200460	8,1	79	37	6111200810
1,2	30	8	6111200120	4,7	58	24	6111200470	8,2	79	37	6111200820
1,3	30	8	6111200130	4,8	62	26	6111200480	8,3	79	37	6111200830
1,4	32	9	6111200140	4,9	62	26	6111200490	8,4	79	37	6111200840
1,5	32	9	6111200150	5,0	62	26	6111200500	8,5	79	37	6111200850
1,6	34	10	6111200160	5,1	62	26	6111200510	8,6	84	40	6111200860
1,7	34	10	6111200170	5,2	62	26	6111200520	8,7	84	40	6111200870
1,8	36	11	6111200180	5,3	62	26	6111200530	8,8	84	40	6111200880
1,9	36	11	6111200190	5,4	66	28	6111200540	8,9	84	40	6111200890
2,0	38	12	6111200200	5,5	66	28	6111200550	9,0	84	40	6111200900
2,1	38	12	6111200210	5,6	66	28	6111200560	9,1	84	40	6111200910
2,2	40	13	6111200220	5,7	66	28	6111200570	9,2	84	40	6111200920
2,3	40	13	6111200230	5,8	66	28	6111200580	9,3	84	40	6111200930
2,4	43	14	6111200240	5,9	66	28	6111200590	9,4	84	40	6111200940
2,5	43	14	6111200250	6,0	66	28	6111200600	9,5	84	40	6111200950
2,6	43	14	6111200260	6,1	70	31	6111200610	9,6	89	43	6111200960
2,7	46	16	6111200270	6,2	70	31	6111200620	9,7	89	43	6111200970
2,8	46	16	6111200280	6,3	70	31	6111200630	9,8	89	43	6111200980
2,9	46	16	6111200290	6,4	70	31	6111200640	9,9	89	43	6111200990
3,0	46	16	6111200300	6,5	70	31	6111200650	10,0	89	43	6111201000
3,1	49	18	6111200310	6,6	70	31	6111200660	10,2	89	43	6111201020
3,2	49	18	6111200320	6,7	70	31	6111200670	10,5	89	43	6111201050
3,3	49	18	6111200330	6,8	74	34	6111200680	11,0	95	47	6111201100
3,4	52	20	6111200340	6,9	74	34	6111200690	11,5	95	47	6111201150
3,5	52	20	6111200350	7,0	74	34	6111200700	12,0	100	51	6111201200
3,6	52	20	6111200360	7,1	74	34	6111200710	12,5	100	51	6111201250
3,7	52	20	6111200370	7,2	74	34	6111200720	12,8	100	51	6111201280
3,8	55	22	6111200380	7,3	74	34	6111200730	13,0	100	51	6111201300
3,9	55	22	6111200390	7,4	74	34	6111200740	14,0	105	54	6111201400
4,0	55	22	6111200400	7,5	74	34	6111200750	14,5	109	56	6111201450
4,1	55	22	6111200410	7,6	79	37	6111200760	15,0	109	56	6111201500
4,2	55	22	6111200420	7,7	79	37	6111200770	16,0	109	58	6111201600
4,3	58	24	6111200430	7,8	79	37	6111200780				
4,4	58	24	6111200440	7,9	79	37	6111200790				

611 110**Spiralbohrer VHM DIN 338 5xØ
Carbide Drills DIN 338 5xØ**

- Breiter Anwendungsbereich
- Stabile Ausführung für Bohrungen 5xØ
- Selbstzentrierender Anschliff
- Oberfläche blank

- Broad field of application
- Rigid version for drillings up to 5xØ
- Self centering 4 facet grinding
- Bright finish

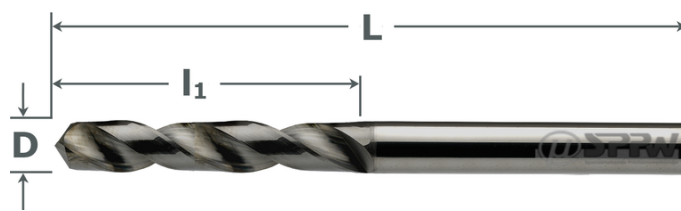

VHM	blank
DIN 338	Typ N
118°	ZYL

ØD h6	L	l1	Art. No.	ØD h6	L	l1	Art. No.	ØD h6	L	l1	Art. No.
0,7	28	9	6111100070	4,2	75	43	6111100420	7,7	117	75	6111100770
0,8	30	10	6111100080	4,3	80	47	6111100430	7,8	117	75	6111100780
0,9	32	11	6111100090	4,4	80	47	6111100440	7,9	117	75	6111100790
1,0	34	12	6111100100	4,5	80	47	6111100450	8,0	117	75	6111100800
1,1	36	14	6111100110	4,6	80	47	6111100460	8,1	117	75	6111100810
1,2	38	16	6111100120	4,7	80	47	6111100470	8,2	117	75	6111100820
1,3	38	16	6111100130	4,8	86	52	6111100480	8,3	117	75	6111100830
1,4	40	18	6111100140	4,9	86	52	6111100490	8,4	117	75	6111100840
1,5	40	18	6111100150	5,0	86	52	6111100500	8,5	117	75	6111100850
1,6	43	20	6111100160	5,1	86	52	6111100510	8,6	125	81	6111100860
1,7	43	20	6111100170	5,2	86	52	6111100520	8,7	125	81	6111100870
1,8	46	22	6111100180	5,3	86	52	6111100530	8,8	125	81	6111100880
1,9	46	22	6111100190	5,4	93	57	6111100540	8,9	125	81	6111100890
2,0	49	24	6111100200	5,5	93	57	6111100550	9,0	125	81	6111100900
2,1	49	24	6111100210	5,6	93	57	6111100560	9,1	125	81	6111100910
2,2	53	27	6111100220	5,7	93	57	6111100570	9,2	125	81	6111100920
2,3	53	27	6111100230	5,8	93	57	6111100580	9,3	125	81	6111100930
2,4	57	30	6111100240	5,9	93	57	6111100590	9,4	125	81	6111100940
2,5	57	30	6111100250	6,0	93	57	6111100600	9,5	125	81	6111100950
2,6	57	30	6111100260	6,1	101	63	6111100610	9,6	133	87	6111100960
2,7	61	33	6111100270	6,2	101	63	6111100620	9,7	133	87	6111100970
2,8	61	33	6111100280	6,3	101	63	6111100630	9,8	133	87	6111100980
2,9	61	33	6111100290	6,4	101	63	6111100640	9,9	133	87	6111100990
3,0	61	33	6111100300	6,5	101	63	6111100650	10,0	140	87	6111101000
3,1	65	36	6111100310	6,6	101	63	6111100660	10,2	133	87	6111101020
3,2	65	36	6111100320	6,7	101	63	6111100670	10,5	133	87	6111101050
3,3	65	36	6111100330	6,8	109	69	6111100680	11,0	142	94	6111101100
3,4	70	39	6111100340	6,9	109	69	6111100690	11,5	151	101	6111101150
3,5	70	39	6111100350	7,0	109	69	6111100700	12,0	151	101	6111101200
3,6	70	39	6111100360	7,1	109	69	6111100710	12,5	151	101	6111101250
3,7	70	39	6111100370	7,2	109	69	6111100720	13,0	151	101	6111101300
3,8	75	43	6111100380	7,3	109	69	6111100730	14,0	160	108	6111101400
3,9	75	43	6111100390	7,4	109	69	6111100740	15,0	160	108	6111101500
4,0	75	43	6111100400	7,5	109	69	6111100750	16,0	165	118	6111101600
4,1	75	43	6111100410	7,6	117	75	6111100760				

D

731 180

Spiralbohrer VHM Sichelform für Faserwerkstoffe Carbide Drills for Aramide Fibre "Sickle Type"



- Präziser Sonderanschliff "Sichelform"
- Textile Fasergewebestoffe (Aramid)
- Keine Delamination
- Oberfläche poliert
- Lieferzeit ca. 5 Arbeitstage
- Weitere Abmessungen auf Anfrage

- Special point geometry "sickle type"
- Textile woven fiber materials (Aramid)
- Prevents delamination
- Polished finish
- Delivery time approx. 5 working days
- Other dimensions on request

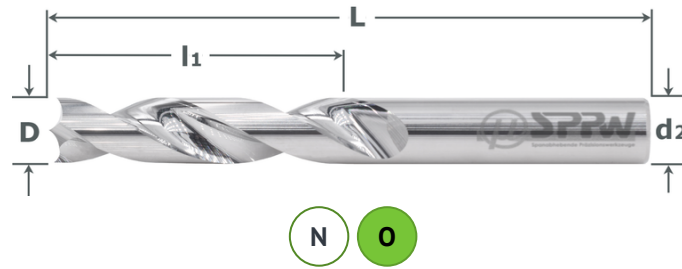

VHM	poliert
AFRP Aramid	Sichel
DIN 6535HA	3xØ

ØD h6	Ød2 h6	L	l1	l2	Art. No.
3	3	40	12		7311800300
4	4	55	18		7311800400
5	5	62	26		7311800500
6	6	66	28		7311800600

ØD h6	Ød2 h6	L	l1	l2	Art. No.
8	8	79	37		7311800800
10	10	89	48		7311801000
12	12	102	50		7311801200

731 170 HC

Bohrreibahlen VHM+Dia.HC für Faserwerkstoffe 3 Schneiden Carbide Drill Reamers+Dia.HC for FRP 3 Flutes



- Delaminierungsfreies Bohren von CFK
- Spezielle Geometrie
- Empfohlene Einsatztiefe 2xØ
- Oberfläche Dia.HC beschichtet

- Delamination free drilling of CFRP
- Special geometry
- Drilling depth recommended 2xØ
- With Dia.HC coating

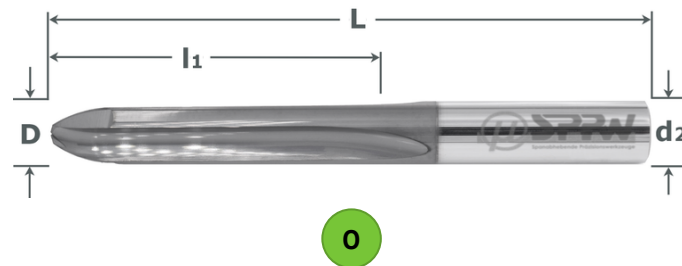

VHM	Dia HC
z:3	DIN 6535HA
OAL 100	GFK CFK

ØD H7	Ød2 h6	L	l1	Art. No.
2	2	100	50	7311700200HC
2,48	2,48	100	50	7311700248HC
3	3	100	50	7311700300HC
3,17	3,17	100	50	7311700317HC
4	4	100	50	7311700400HC
4,21	4,21	100	50	7311700421HC
4,82	4,82	100	50	7311700482HC
5,05	5,05	100	50	7311700505HC
5,53	5,53	100	50	7311700553HC

ØD H7	Ød2 h6	L	l1	Art. No.
6	6	100	50	7311700600HC
6,35	6,35	100	50	7311700635HC
7	7	100	50	7311700700HC
7,92	7,92	100	50	7311700792HC
8	8	100	50	7311700800HC
8,63	8,63	100	50	7311700863HC
9	9	100	50	7311700900HC
10	10	100	50	7311701000HC
12	12	100	50	7311701200HC

761 540

Hochleistungs-Kühlkanalbohrer VHM+Z.Cut Aluminium 5xØ Carbide High Performance Drills+Z.Cut Internal Cooling Aluminium 5xØ



- Für langspanende Werkstoffe
- Innenkühlung, Mindestdruck 30 bar
- Kontrollierter Spanbruch, gute Abfuhr
- Oberfläche Z.Cut beschichtet
- Lieferzeit ca. 5 Arbeitstage
- For long chipping materials
- Internal cooling, minimum 30 bar
- Controlled chipping, good transport
- With Z.Cut coating
- Delivery time 5 working days

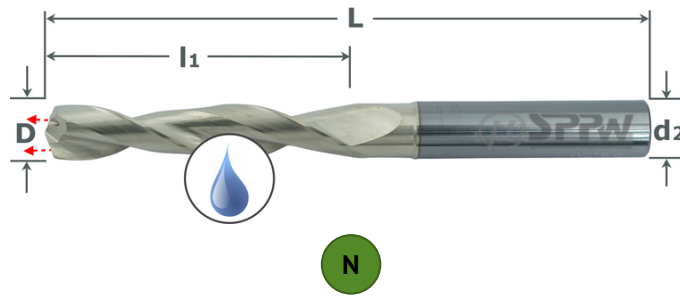

VHM	Z Cut
DIN 6537L	Typ W
130°	DIN 6535HA
5xØ	IK cool

ØD m7	Ød2 h6	L	l1	Art. No.	ØD m7	Ød2 h6	L	l1	Art. No.
3	6	66	28	7615400300	7	8	91	53	7615400700
3,1	6	66	28	7615400310	7,5	8	91	53	7615400750
3,3	6	66	28	7615400330	7,8	8	91	53	7615400780
3,5	6	66	28	7615400350	8	8	91	53	7615400800
3,7	6	66	28	7615400370	8,5	10	103	61	7615400850
3,8	6	74	36	7615400380	8,8	10	103	61	7615400880
4	6	74	36	7615400400	9	10	103	61	7615400900
4,2	6	74	36	7615400420	9,2	10	103	61	7615400920
4,5	6	74	36	7615400450	9,5	10	103	61	7615400950
4,8	6	82	44	7615400480	9,8	10	103	61	7615400980
5	6	82	44	7615400500	10	10	103	61	7615401000
5,1	6	82	44	7615400510	10,2	12	118	71	7615401020
5,2	6	82	44	7615400520	10,5	12	118	71	7615401050
5,5	6	82	44	7615400550	10,8	12	118	71	7615401080
5,8	6	82	44	7615400580	11	12	118	71	7615401100
6	6	82	44	7615400600	11,5	12	118	71	7615401150
6,3	8	91	53	7615400630	11,8	12	118	71	7615401180
6,5	8	91	53	7615400650	12	12	118	71	7615401200
6,8	8	91	53	7615400680					

— INFO —

761 540 - Aluminium und NE-Metalle | Aluminum and NF-Metals



761 232

Hochleistungsbohrer VHM+X.Cut Hartbearbeitung 3xØ Carbide High Performance Drills+X.Cut Hard Cutting 3xØ



- Hochleistungsbohrer Hartbearbeitung
- Gehärtete Stähle bis max. 65 HRC
- Kurze Ausführung verstärktem Schaft
- Oberfläche X.Cut beschichtet
- Lieferzeit ca. 5 Arbeitstage
- High performance hard drilling
- Hardened steels up to 65 HRC
- Short version with reinforced shank
- With X.Cut coating
- Delivery time 5 working days

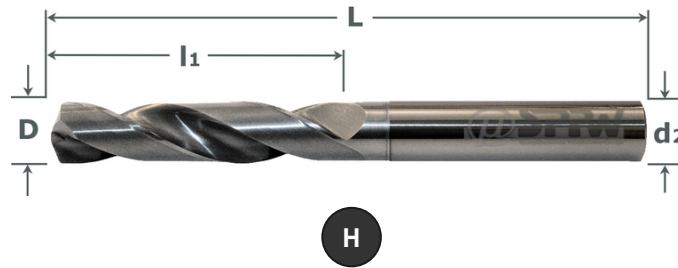

VHM	X Cut
DIN 6537K	Typ N
140°	DIN 6535HA
3xØ	65 HRC

ØD h7	Ød2 h6	L	l1	Art. No.	ØD h7	Ød2 h6	L	l1	Art. No.
2,8	6	62	20	7612320280	8,5	10	89	47	7612320850
3	6	62	20	7612320300	8,8	10	89	47	7612320880
3,3	6	62	20	7612320330	9	10	89	47	7612320900
3,5	6	62	20	7612320350	10	10	89	47	7612321000
3,8	6	66	24	7612320380	10,2	12	102	55	7612321020
4	6	66	24	7612320400	10,5	12	102	55	7612321050
4,2	6	66	24	7612320420	10,8	12	102	55	7612321080
4,3	6	66	24	7612320430	11	12	102	55	7612321100
4,5	6	66	24	7612320450	11,8	12	102	55	7612321180
4,8	6	66	28	7612320480	12	12	102	55	7612321200
5	6	66	28	7612320500	12,8	14	107	60	7612321280
5,5	6	66	28	7612320550	13	14	107	60	7612321300
5,8	6	66	28	7612320580	13,8	14	107	60	7612321380
6	6	66	28	7612320600	14	14	107	60	7612321400
6,5	8	79	34	7612320650	14,8	16	115	65	7612321480
6,8	8	79	34	7612320680	15	16	115	65	7612321500
7	8	79	34	7612320700	15,8	16	115	65	7612321580
7,8	8	79	41	7612320780	16	16	115	65	7612321600
8	8	79	41	7612320800					

659 220

Spiralbohrer mit HM-Schneidplatte 3xØ Carbide Tipped Drills 3xØ



- Breiter Anwendungsbereich
- Stabile Ausführung für Bohrungen 3xØ
- 4-Flächen-Anschliff
- Mitnehmer nach DIN 1809
- Oberfläche blank

- Broad field of application
- Rigid version for drillings up to 3xØ
- 4 facet grinding
- Tongue end acc. to DIN 1809
- Bright finish

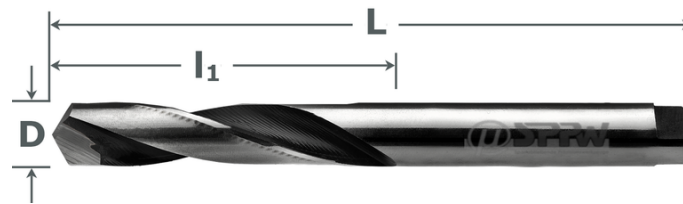

HMP	blank
DIN 8037	Typ N
118°	ZYL

ØD h7	L	l1	Art. No.	ØD h7	L	l1	Art. No.	ØD h7	L	l1	Art. No.
2	45	18	6592200200	5,2	71	32	6592200520	10	100	56	6592201000
2,5	45	18	6592200250	5,5	71	32	6592200550	10,5	100	56	6592201050
3	50	20	6592200300	6	71	32	6592200600	11	100	56	6592201100
3,2	56	25	6592200320	6,5	71	32	6592200650	12	112	63	6592201200
3,5	56	25	6592200350	7	80	40	6592200700	13	112	63	6592201300
4	56	25	6592200400	7,5	80	40	6592200750	14	125	71	6592201400
4,1	63	28	6592200410	8	80	40	6592200800	15	125	71	6592201500
4,2	63	28	6592200420	8,5	90	50	6592200850	16	140	80	6592201600
4,5	63	28	6592200450	9	90	50	6592200900				
5	63	28	6592200500	9,5	90	50	6592200950				

659 221

Spiralbohrer mit HM-Schneidplatte Hartbearbeitung 3xØ Carbide Tipped Drills Hard Cutting 3xØ



- Gehärtete Stähle bis 60 HRC
- Negativer Plattenwinkel
- Mitnehmer nach DIN 1809
- Oberfläche blank

- Hardened steels up to 60 HRC
- Carbide tip with negative angle
- Tongue end acc. to DIN 1809
- Bright finish

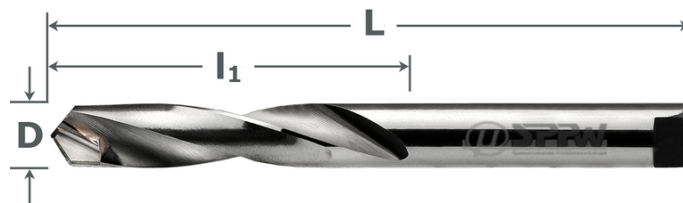

HMP	blank
DIN 8037	Typ H
118°	DIN 1809
60 HRC	

ØD h7	L	l1	Art. No.	ØD h7	L	l1	Art. No.	ØD h7	L	l1	Art. No.
3	50	20	6592210300	5,8	71	32	6592210580	9,5	90	50	6592210950
3,2	56	25	6592210320	6	71	32	6592210600	9,8	100	56	6592210980
3,3	56	25	6592210330	6,5	71	32	6592210650	10	100	56	6592211000
3,5	56	25	6592210350	6,8	80	40	6592210680	10,2	100	56	6592211020
4	56	25	6592210400	7	80	40	6592210700	10,5	100	56	6592211050
4,2	63	28	6592210420	7,5	80	40	6592210750	11	100	56	6592211100
4,5	63	28	6592210450	7,8	80	40	6592210780	12	112	63	6592211200
4,8	63	28	6592210480	8	80	40	6592210800	13	112	63	6592211300
5	63	28	6592210500	8,5	90	50	6592210850				
5,5	71	32	6592210550	9	90	50	6592210900				

659 230**Spiralbohrer mit HM-Schneidplatte 5xØ
Carbide Tipped Drills 5xØ**

- Breiter Anwendungsbereich
- Stabile Ausführung, Bohrungen 5xØ
- 4-Flächen-Anschliff
- Oberfläche blank
- Broad field of application
- Rigid version for drilling 5xØ
- 4 facet grinding
- Bright finish



HMP	blank
DIN 338	Typ N
118°	ZYL

**D**

ØD h7	L	l1	Art. No.	ØD h7	L	l1	Art. No.	ØD h7	L	l1	Art. No.
2	49	24	6592300200	4,5	80	47	6592300450	8	117	75	6592300800
2,1	49	24	6592300210	4,6-4,7	80	47	659230xxxx	8,1-8,4	117	75	659230xxxx
2,2-2,3	53	27	659230xxxx	4,8-4,9	86	52	659230xxxx	8,5	117	75	6592300850
2,4	57	30	6592300240	5	86	52	6592300500	8,6-8,9	125	81	659230xxxx
2,5	57	30	6592300250	5,1-5,3	86	52	659230xxxx	9	125	81	6592300900
2,6	57	30	6592300260	5,4	93	57	6592300540	9,1-9,4	125	81	659230xxxx
2,7-2,9	61	33	659230xxxx	5,5	93	57	6592300550	9,5	125	81	6592300950
3	61	33	6592300300	5,6-5,9	93	57	659230xxxx	9,6-9,9	133	87	659230xxxx
3,1-3,3	65	36	659230xxxx	6	93	57	6592300600	10	133	87	6592301000
3,4	70	39	6592300340	6,1-6,4	101	63	659230xxxx	10,2	133	87	6592301020
3,5	70	39	6592300350	6,5	101	63	6592300650	10,5	133	87	6592301050
3,6-3,7	70	39	659230xxxx	6,6-6,9	109	69	659230xxxx	11	142	94	6592301100
3,8-3,9	75	43	659230xxxx	7	109	69	6592300700	11,5	142	94	6592301150
4	75	43	6592300400	7,1-7,4	109	69	659230xxxx	12	151	101	6592301200
4,1-4,2	75	43	659230xxxx	7,5	109	69	6592300750				
4,3-4,4	80	47	659230xxxx	7,6-7,9	117	75	659230xxxx				

INFO**Spiralbohrer mit HM-Schneidplatte**

Wir verwenden Hochtemperaturlot mit deutlich höherer Schmelztemperatur. Die Hartmetall-platte wird zeitgleich mit dem Härten des Grundkörpers eingelötet. Hierdurch wird ein neuerliches Anlassen des HSS-Körpers vermieden. Der Bohrer hat eine höhere Festigkeit und bessere Toleranzhaltigkeit.

Carbide Tipped-Drills

We use high-temperature brazing alloy with a significantly higher melting temperature. The carbide plate is brazed in at the same time as the base body is hardened. This avoids renewed tempering of the HSS body. The drill has a higher strength and better tolerance.





- Speziell für Faserkunststoffe
- Spitzenwinkel 90°
- 4-Flächen-Anschliff
- Oberfläche blank
- Fiber reinforced plastics
- Point angle 90°
- 4 facet grinding
- Bright finish



HMP	blank
DIN 338	90°
ZYL	GFK CFK

ØD h7	L	l1	Art. No.	ØD h7	L	l1	Art. No.	ØD h7	L	l1	Art. No.
2,5	57	30	6592310250	6	93	57	6592310600	9,9	133	87	6592310990
3	61	33	6592310300	6,1	101	63	6592310610	10	133	87	6592311000
3,5	70	39	6592310350	6,5	101	63	6592310650	10,5	133	87	6592311050
4	75	43	6592310400	6,6	109	69	6592310660	11	142	94	6592311100
4,1	75	43	6592310410	6,8	109	69	6592310680	11,5	142	94	6592311150
4,2	75	43	6592310420	7	109	69	6592310700	12	151	101	6592311200
4,5	80	47	6592310450	7,5	109	69	6592310750	12,2	151	101	6592311220
4,9	86	52	6592310490	8	117	75	6592310800	12,5	151	101	6592311250
5	86	52	6592310500	8,2	117	75	6592310820	13	151	101	6592311300
5,1	86	52	6592310510	8,5	117	75	6592310850	13,5	160	108	6592311350
5,5	93	57	6592310550	9	125	81	6592310900	14	160	108	6592311400
5,7	93	57	6592310570	9,4	125	81	6592310940	15	169	114	6592311500
5,8	93	57	6592310580	9,5	125	81	6592310950	16	178	120	6592311600

— INFO —

GFK - CFK | GFRP- CFRP

Spitzenwinkel 90° erzeugt geringeren Bohrdruck und somit weniger Delamination!

Point angle 90° generates less drilling pressure and thus less delamination!



659 240**Spiralbohrer mit HM-Schneidplatte
Carbide Tipped Drills 8xØ**

- Lange Ausführung
- Diamantgeschliffene Hartmetall-Platte
- Stabile Ausführung, Bohrungen bis 8Ø
- 4-Flächen-Anschliff
- Oberfläche blank

- Long version
- Good concentricity, diamond ground
- Carbide tipped long length drill
- Rigid version for drillings 8xØ
- 4 facet grinding
- Bright finish



HMP	blank
DIN 340	Typ N
118°	ZYL

ØD h7	L	l1	Art. No.
1,8-1,9	80	53	659240xxxx
2	85	56	6592400200
2,1	85	56	6592400210
2,2-2,3	90	59	659240xxxx
2,4	95	62	6592400240
2,5	95	62	6592400250
2,6	95	62	6592400260
2,7-2,9	100	66	659240xxxx
3	100	66	6592400300
3,1-3,3	106	69	659240xxxx
3,4	112	73	6592400340
3,5	112	73	6592400350
3,6-3,7	112	73	659240xxxx
3,8-3,9	119	78	659240xxxx
4	119	78	6592400400
4,1-4,2	119	78	659240xxxx
4,3-4,4	126	82	659240xxxx
4,5	126	82	6592400450
4,6-4,7	126	82	659240xxxx
4,8-4,9	132	87	659240xxxx
5	132	87	6592400500
5,1-5,3	132	87	659240xxxx
5,4	139	91	6592400540
5,5	139	91	6592400550
5,6-5,9	139	91	659240xxxx
6	139	91	6592400600
6,1-6,4	148	97	659240xxxx
6,5	148	97	6592400650

ØD h7	L	l1	Art. No.
6,6-6,7	148	97	659240xxxx
6,8-6,9	156	102	659240xxxx
7	156	102	6592400700
7,1-7,4	156	102	659240xxxx
7,5	156	102	6592400750
7,6-7,9	165	109	659240xxxx
8	165	109	6592400800
8,1-8,4	165	109	659240xxxx
8,5	165	109	6592400850
9	175	115	6592400900
9,5	175	115	6592400950
10	184	121	6592401000
10,5	184	121	6592401050
11	195	128	6592401100
11,5	195	128	6592401150
12	205	134	6592401200
12,5	205	134	6592401250
13	205	134	6592401300
13,5	214	140	6592401350
14	214	140	6592401400
14,5	220	144	6592401450
15	220	144	6592401500
16	227	149	6592401600
17	235	154	6592401700
18	241	158	6592401800
19	247	162	6592401900
20	254	166	6592402000

658 900

Spiralbohrer mit HM-Schneidplatte MK-Schaft 3xØ Carbide Tipped Drills Morse Taper Shank 3xØ



- Breiter Anwendungsbereich
- Stabile Ausführung für Bohrungen 3xØ
- 4-Flächen-Anschliff
- MK-Schaft
- Oberfläche blank

- Broad field of application
- Rigid version for drillings up to 3xØ
- 4 facet grinding
- Morse taper shank
- Bright finish

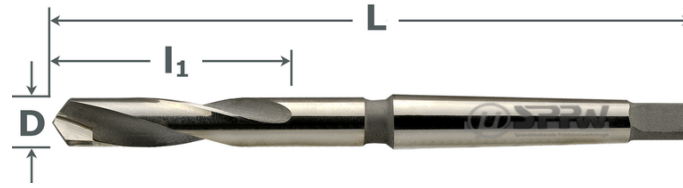

HMP	blank
DIN 8041	Typ N
118°	MK MTS
3xØ	



ØD h7	L	l1	MK MTS	Art. No.
8,5	135	45	1	6589000850
9	135	45	1	6589000900
9,5	135	45	1	6589000950
10	140	50	1	6589001000
10,5	140	50	1	6589001050
11	140	50	1	6589001100
11,5	146	56	1	6589001150
12	146	56	1	6589001200
12,5	146	56	1	6589001250
13	146	56	1	6589001300
13,5	168	63	2	6589001350
14	168	63	2	6589001400
14,5	168	63	2	6589001450
15	168	63	2	6589001500
15,5	175	70	2	6589001550
16	175	70	2	6589001600
16,5	175	70	2	6589001650
17	175	70	2	6589001700
17,5	185	80	2	6589001750

ØD h7	L	l1	MK MTS	Art. No.
18	185	80	2	6589001800
18,5	185	80	2	6589001850
19	185	80	2	6589001900
19,5	215	90	3	6589001950
20	215	90	3	6589002000
20,5	215	90	3	6589002050
21	215	90	3	6589002100
22	215	90	3	6589002200
23	225	100	3	6589002300
24	225	100	3	6589002400
25	225	100	3	6589002500
26	260	110	4	6589002600
27	260	110	4	6589002700
28	260	110	4	6589002800
29	275	125	4	6589002900
30	275	125	4	6589003000
31	275	125	4	6589003100
32	275	125	4	6589003200
35	275	125	4	6589003500



- Spezielle Geometrie für kleine Ø
- 4-Flächen-Anschliff
- Verstärkter Schaft ähnl. DIN 1899
- bis Ø0,8 mm hundertstel steigend
- Oberfläche blank
- △ Verpackungseinheit 10 Stück

- Special geometry for small Ø
- 4 facet grinding
- Reinforced shank sim. DIN 1899
- up to 0,8 mm 1/100 increments
- Bright finish
- △ Packaging unit 10 pieces

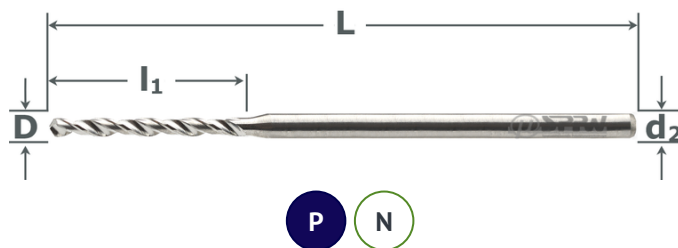

HSS E05	blank
DIN 1899	Typ N
118°	ZYL
1/100	

ØD h6	L	l1	Ød2 h8	Art. No.	ØD h6	L	l1	Ød2 h8	Art. No.
0,15	25	1,0	1,0	4111210015	0,85	25	5,5	1,5	4111210085
0,16-0,19	25	1,4	1,0	411121xxxx	0,90	25	6,0	1,5	4111210090
0,20-0,24	25	1,8	1,0	411121xxxx	0,95	25	6,0	1,5	4111210095
0,25-0,30	25	2,2	1,0	411121xxxx	1,00	25	6,5	1,5	4111210100
0,31-0,38	25	2,8	1,0	411121xxxx	1,05	25	6,5	1,5	4111210105
0,40-0,45	25	3,2	1,0	411121xxxx	1,10	25	7,0	1,5	4111210110
0,46-0,50	25	3,6	1,0	411121xxxx	1,20	25	7,5	1,5	4111210120
0,47-0,50	25	3,6	1,0	411121xxxx	1,25	25	7,5	1,5	4111210125
0,51-0,55	25	4,0	1,5	411121xxxx	1,30	25	7,5	1,5	4111210130
0,56-0,60	25	4,5	1,5	411121xxxx	1,35	25	8,5	1,5	4111210135
0,61-0,65	25	4,7	1,5	411121xxxx	1,40	25	8,5	1,5	4111210140
0,68-0,75	25	5,2	1,5	411121xxxx	1,45	25	8,5	1,5	4111210145
0,76-0,80	25	5,5	1,5	411121xxxx					

— INFO —

Kleinstbohrer aus HSS-E (411121) und VHM (611121): Verpackungseinheit 10 Stück

HSS-E micro drills (411 121) and carbide micro drills (611 121): packaging unit 10 pieces



— INFO —

Mini.338 Kleinstbohrer aus HSS-E nach DIN 338 im

- Durchmesserbereich von 0,8 - 2,45 mm
- Universalgeometrie mit höchster Präzision
- Blank oder mit X.Cut Beschichtung

Mini.338 HSS-E miniature drills according to DIN 338

- diameters 0.8 - 2.45 mm
- Universal geometry with highest precision
- Uncoated or with X.Cut coating



411 221

Kleinstbohrer HSS-E05 DIN 338 HSS-E05 Miniature Drills DIN 338



- Breiter Anwendungsbereich
- Spezielle Geometrie für kleine Ø
- 4-Flächen-Anschliff
- Zylinderschaft gem. DIN 338
- Oberfläche blank

- Broad field of application
- Special geometry for small Ø
- 4 facet grinding
- Cylindrical shank acc. to DIN 338
- Bright finish

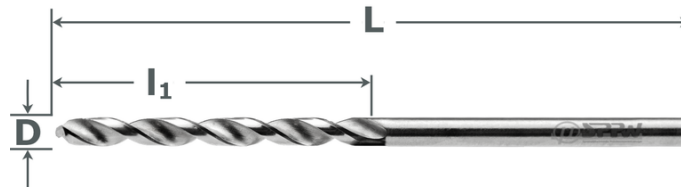

HSS E05	blank
DIN 338	Typ N
130°	ZYL

ØD h8	L	l1	Art. No.
0,80	30	10	4112210080
0,85	30	10	4112210085
0,90	32	11	4112210090
0,95	32	11	4112210095
1,00	34	12	4112210100
1,05	34	12	4112210105
1,10	36	14	4112210110
1,15	36	14	4112210115
1,20	38	16	4112210120
1,25	36	16	4112210125
1,30	36	16	4112210130
1,35	40	18	4112210135

ØD h8	L	l1	Art. No.
1,40	40	18	4112210140
1,45	40	18	4112210145
1,50	40	18	4112210150
1,55	43	20	4112210155
1,60	43	20	4112210160
1,65	43	20	4112210165
1,70	43	20	4112210170
1,75	46	22	4112210175
1,80	46	22	4112210180
1,85	46	22	4112210185
1,90	46	22	4112210190
1,95	49	24	4112210195

ØD h8	L	l1	Art. No.
2,00	49	24	4112210200
2,05	49	24	4112210205
2,10	49	24	4112210210
2,15	53	27	4112210215
2,20	53	27	4112210220
2,25	53	27	4112210225
2,30	53	27	4112210230
2,35	53	27	4112210235
2,40	57	30	4112210240
2,45	57	30	4112210245

411 227

Kleinstbohrer HSS-E05+X.Cut DIN 338 HSS-E05 Miniature Drills+X.Cut DIN 338



- Breiter Anwendungsbereich
- Spezielle Geometrie für kleine Ø
- 4-Flächen-Anschliff
- Zylinderschaft gem. DIN 338
- Oberfläche X.Cut beschichtet

- Broad field of application
- Special geometry for small Ø
- 4 facet grinding
- Cylindrical shank acc. to DIN 338
- With X.Cut coating

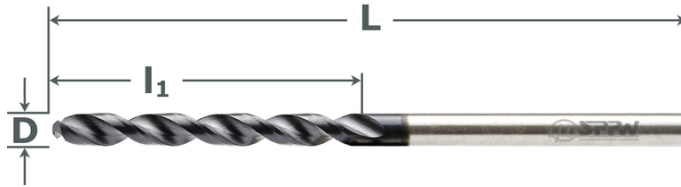

HSS E05	X Cut
DIN 338	Typ N
130°	ZYL

ØD h8	L	l1	Art. No.
0,80	30	10	4112270080
0,85	30	10	4112270085
0,90	32	11	4112270090
0,95	32	11	4112270095
1,00	34	12	4112270100
1,05	34	12	4112270105
1,10	36	14	4112270110
1,15	36	14	4112270115
1,20	38	16	4112270120
1,25	36	16	4112270125
1,30	36	16	4112270130
1,35	40	18	4112270135

ØD h8	L	l1	Art. No.
1,40	40	18	4112270140
1,45	40	18	4112270145
1,50	40	18	4112270150
1,55	43	20	4112270155
1,60	43	20	4112270160
1,65	43	20	4112270165
1,70	43	20	4112270170
1,75	46	22	4112270175
1,80	46	22	4112270180
1,85	46	22	4112270185
1,90	46	22	4112270190
1,95	49	24	4112270195

ØD h8	L	l1	Art. No.
2,00	49	24	4112270200
2,05	49	24	4112270205
2,10	49	24	4112270210
2,15	53	27	4112270215
2,20	53	27	4112270220
2,25	53	27	4112270225
2,30	53	27	4112270230
2,35	53	27	4112270235
2,40	57	30	4112270240
2,45	57	30	4112270245



- Universeller Hochleistungsbohrer
- Besonders stabile Ausführung
- Flachnutspirale und verstärkter Kern
- Anschliff ähnlich DIN 1412B
- Oberfläche blank
- Universal high performance drill
- Extremely rigid and robust
- Parabolic flutes and reinforced web
- Self centering point similar DIN 1412 B
- Bright finish

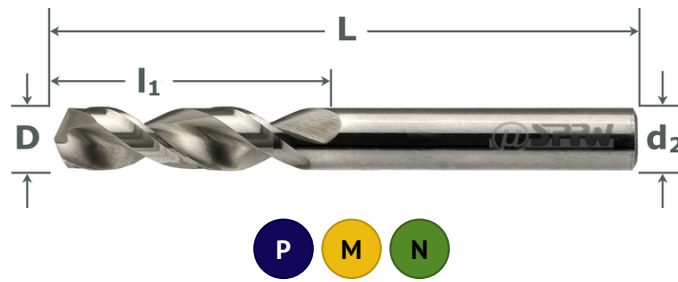

HSS E05	blank
DIN 1897	Typ ZX
130°	ZYL

D

ØD h8	L	l1	Art. No.	ØD h8	L	l1	Art. No.	ØD h8	L	l1	Art. No.
2,0	38	12	4111200200	6,2	70	31	4111200620	10,4	89	43	4111201040
2,1	38	12	4111200210	6,3	70	31	4111200630	10,5	89	43	4111201050
2,2	40	13	4111200220	6,4	70	31	4111200640	10,6	89	43	4111201060
2,3	40	13	4111200230	6,5	70	31	4111200650	10,7	95	47	4111201070
2,4	43	14	4111200240	6,6	70	31	4111200660	10,8	95	47	4111201080
2,5	43	14	4111200250	6,7	70	31	4111200670	10,9	95	47	4111201090
2,6	43	14	4111200260	6,8	74	34	4111200680	11,0	95	47	4111201100
2,7	46	16	4111200270	6,9	74	34	4111200690	11,1	95	47	4111201110
2,8	46	16	4111200280	7,0	74	34	4111200700	11,2	95	47	4111201120
2,9	46	16	4111200290	7,1	74	34	4111200710	11,3	95	47	4111201130
3,0	46	16	4111200300	7,2	74	34	4111200720	11,4	95	47	4111201140
3,1	49	18	4111200310	7,3	74	34	4111200730	11,5	95	47	4111201150
3,2	49	18	4111200320	7,4	74	34	4111200740	11,6	95	47	4111201160
3,3	49	18	4111200330	7,5	74	34	4111200750	11,7	95	47	4111201170
3,4	52	20	4111200340	7,6	79	37	4111200760	11,8	95	47	4111201180
3,5	52	20	4111200350	7,7	79	37	4111200770	11,9	102	51	4111201190
3,6	52	20	4111200360	7,8	79	37	4111200780	12,0	102	51	4111201200
3,7	52	20	4111200370	7,9	79	37	4111200790	12,1	102	51	4111201210
3,8	55	22	4111200380	8,0	79	37	4111200800	12,2	102	51	4111201220
3,9	55	22	4111200390	8,1	79	37	4111200810	12,3	102	51	4111201230
4,0	55	22	4111200400	8,2	79	37	4111200820	12,4	102	51	4111201240
4,1	55	22	4111200410	8,3	79	37	4111200830	12,5	102	51	4111201250
4,2	55	22	4111200420	8,4	79	37	4111200840	12,6	102	51	4111201260
4,3	58	24	4111200430	8,5	79	37	4111200850	12,7	102	51	4111201270
4,4	58	24	4111200440	8,6	84	40	4111200860	12,8	102	51	4111201280
4,5	58	24	4111200450	8,7	84	40	4111200870	12,9	102	51	4111201290
4,6	58	24	4111200460	8,8	84	40	4111200880	13,0	102	51	4111201300
4,7	58	24	4111200470	8,9	84	40	4111200890	13,5	107	54	4111201350
4,8	62	26	4111200480	9,0	84	40	4111200900	14,0	107	54	4111201400
4,9	62	26	4111200490	9,1	84	40	4111200910	14,5	111	56	4111201450
5,0	62	26	4111200500	9,2	84	40	4111200920	15,0	111	56	4111201500
5,1	62	26	4111200510	9,3	84	40	4111200930	15,5	115	58	4111201550
5,2	62	26	4111200520	9,4	84	40	4111200940	16,0	115	58	4111201600
5,3	62	26	4111200530	9,5	84	40	4111200950	16,5	119	60	4111201650
5,4	66	28	4111200540	9,6	89	43	4111200960	17,0	119	60	4111201700
5,5	66	28	4111200550	9,7	89	43	4111200970	17,5	123	62	4111201750
5,6	66	28	4111200560	9,8	89	43	4111200980	18,0	123	62	4111201800
5,7	66	28	4111200570	9,9	89	43	4111200990	18,5	127	64	4111201850
5,8	66	28	4111200580	10,0	89	43	4111201000	19,0	127	64	4111201900
5,9	66	28	4111200590	10,1	89	43	4111201010	19,5	131	66	4111201950
6,0	66	28	4111200600	10,2	89	43	4111201020	20,0	131	66	4111202000
6,1	70	31	4111200610	10,3	89	43	4111201030				



- Universeller Hochleistungsbohrer
- Besonders stabile Ausführung
- Flachnutspirale und verstärkter Kern
- Spitzenanschliff ähnlich DIN 1412 B
- Oberfläche X.Cut beschichtet

- Universal high performance drill
- Extremely rigid and robust
- Parabolic flutes and reinforced web
- Self centering similar DIN 1412 B
- With X.Cut coating

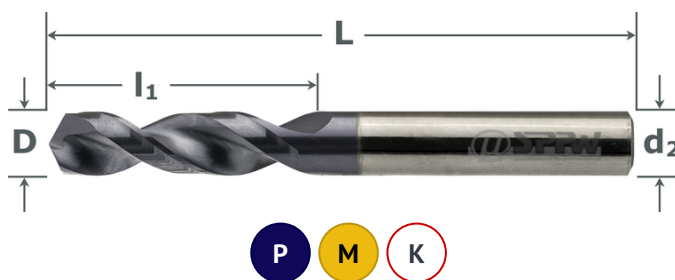

HSS E05	X Cut
DIN 1897	Typ ZX
130°	ZYL

ØD h8	L	l1	Art. No.
2,0	38	12	4111270200
2,1	38	12	4111270210
2,2	40	13	4111270220
2,3	40	13	4111270230
2,4	43	14	4111270240
2,5	43	14	4111270250
2,6	43	14	4111270260
2,7	46	16	4111270270
2,8	46	16	4111270280
2,9	46	16	4111270290
3,0	46	16	4111270300
3,1	49	18	4111270310
3,2	49	18	4111270320
3,3	49	18	4111270330
3,4	52	20	4111270340
3,5	52	20	4111270350
3,6	52	20	4111270360
3,7	52	20	4111270370
3,8	55	22	4111270380
3,9	55	22	4111270390
4,0	55	22	4111270400
4,1	55	22	4111270410
4,2	55	22	4111270420
4,3	58	24	4111270430
4,4	58	24	4111270440
4,5	58	24	4111270450
4,6	58	24	4111270460
4,7	58	24	4111270470
4,8	62	26	4111270480
4,9	62	26	4111270490
5,0	62	26	4111270500
5,1	62	26	4111270510
5,2	62	26	4111270520
5,3	62	26	4111270530
5,4	66	28	4111270540
5,5	66	28	4111270550
5,6	66	28	4111270560
5,7	66	28	4111270570
5,8	66	28	4111270580
5,9	66	28	4111270590
6,0	66	28	4111270600
6,1	70	31	4111270610

ØD h8	L	l1	Art. No.
6,2	70	31	4111270620
6,3	70	31	4111270630
6,4	70	31	4111270640
6,5	70	31	4111270650
6,6	70	31	4111270660
6,7	70	31	4111270670
6,8	74	34	4111270680
6,9	74	34	4111270690
7,0	74	34	4111270700
7,1	74	34	4111270710
7,2	74	34	4111270720
7,3	74	34	4111270730
7,4	74	34	4111270740
7,5	74	34	4111270750
7,6	79	37	4111270760
7,7	79	37	4111270770
7,8	79	37	4111270780
7,9	79	37	4111270790
8,0	79	37	4111270800
8,1	79	37	4111270810
8,2	79	37	4111270820
8,3	79	37	4111270830
8,4	79	37	4111270840
8,5	79	37	4111270850
8,6	84	40	4111270860
8,7	84	40	4111270870
8,8	84	40	4111270880
8,9	84	40	4111270890
9,0	84	40	4111270900
9,1	84	40	4111270910
9,2	84	40	4111270920
9,3	84	40	4111270930
9,4	84	40	4111270940
9,5	84	40	4111270950
9,6	89	43	4111270960
9,7	89	43	4111270970
9,8	89	43	4111270980
9,9	89	43	4111270990
10,0	89	43	4111271000
10,1	89	43	4111271010
10,2	89	43	4111271020
10,3	89	43	4111271030

ØD h8	L	l1	Art. No.
10,4	89	43	4111271040
10,5	89	43	4111271050
10,6	89	43	4111271060
10,7	95	47	4111271070
10,8	95	47	4111271080
10,9	95	47	4111271090
11,0	95	47	4111271100
11,1	95	47	4111271110
11,2	95	47	4111271120
11,3	95	47	4111271130
11,4	95	47	4111271140
11,5	95	47	4111271150
11,6	95	47	4111271160
11,7	95	47	4111271170
11,8	95	47	4111271180
11,9	102	51	4111271190
12,0	102	51	4111271200
12,1	102	51	4111271210
12,2	102	51	4111271220
12,3	102	51	4111271230
12,4	102	51	4111271240
12,5	102	51	4111271250
12,6	102	51	4111271260
12,7	102	51	4111271270
12,8	102	51	4111271280
12,9	102	51	4111271290
13,0	102	51	4111271300
13,5	107	54	4111271350
14,0	107	54	4111271400
14,5	111	56	4111271450
15,0	111	56	4111271500
15,5	115	58	4111271550
16,0	115	58	4111271600
16,5	119	60	4111271650
17,0	119	60	4111271700
17,5	123	62	4111271750
18,0	123	62	4111271800
18,5	127	64	4111271850
19,0	127	64	4111271900
19,5	131	66	4111271950
20,0	131	66	4111272000



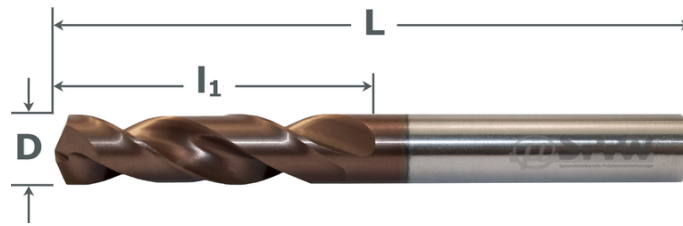

- Ni/Co-Sonderlegierungen, Hardox
- Besonders stabile Ausführung
- Kreuzanschliff ähnlich DIN 1412 C
- Oberfläche X4.Cut beschichtet
- Ni/Co alloys - Hardox
- Extremely rigid and robust
- Split point DIN 1412 C
- With X4.Cut coating

HSS
E05X
CutDIN
1897

135°

ZYL

Hardox

S

D h7	L	l1	Art. No.	D h7	L	l1	Art. No.	D h7	L	l1	Art. No.
2	38	12	4111550200	6,5	70	31	4111550650	11	95	47	4111551100
2,5	43	14	4111550250	6,8	74	34	4111550680	11,5	95	47	4111551150
3	46	16	4111550300	7	74	34	4111550700	12	102	51	4111551200
3,3	49	18	4111550330	7,5	74	34	4111550750	12,5	102	51	4111551250
3,5	52	20	4111550350	8	79	37	4111550800	13	102	51	4111551300
4	55	22	4111550400	8,5	79	37	4111550850	14	107	54	4111551400
4,2	55	22	4111550420	9	84	40	4111550900	15	111	56	4111551500
4,5	58	24	4111550450	9,5	84	40	4111550950	16	115	58	4111551600
5	62	26	4111550500	10	89	43	4111551000	18	123	62	4111551800
5,5	66	28	4111550550	10,2	89	43	4111551020				
6	66	28	4111550600	10,5	89	43	4111551050				

INFO

- 1 - Hochleistungsbohrer für CNC-Bearbeitung oder stationäres Bohren von verschleißfesten Stählen (z.B. HARDOX®)
- 2 - Speziell verstärkter Kern für verbesserte Widerstandsfähigkeit gegen Schnittkräfte
- 3 - X.Cut Beschichtung für reduzierten Verschleiß an den Schneiden reduziert

Vermeiden Sie Vibrationen beim Bohren:

- Minimieren Sie den Abstand zwischen Bohrer und Werkstück
- Spannen Sie das Werkstück sicher ein
- Kurze Bohrer verwenden, um die Durchbiegung zu minimieren
- Für reichlich Kühlmittelzufuhr sorgen

- 1 - High performance drill for CNC or stationary drilling
- 2 - Specially reinforced web for improved resistance against cutting stress
- 3 - X.Cut coating that reduces wear on the cutting edges

Avoid vibrations when drilling:

- Minimize the distance between drill and column
- Clamp the workpiece securely
- Use short drill bits in order to minimize flexure
- Provide abundant supply of coolant

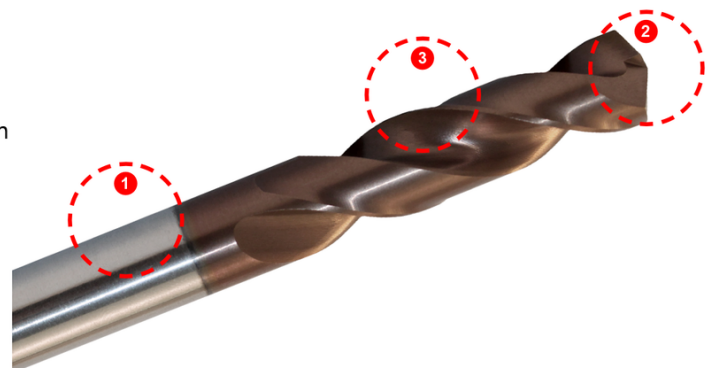

411 140

Spiralbohrer HSS-E05 Hochleistung 5xØ HSS-E05 Drills High Performance 5xØ



- Universeller Hochleistungsbohrer
- Sehr stabil für mittlere Bohrtiefen
- Flachnutspirale und verstärkter Kern
- Spitzenanschliff ähnl. DIN 1412 B
- Oberfläche blank

- Universal high performance drill
- Very rigid for medium depth drilling
- Parabolic flutes and reinforced core
- Self centering similar DIN 1412 B
- Bright finish

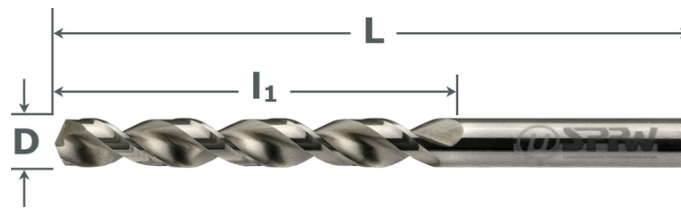

HSS E05	blank
DIN 338	Typ ZX
130°	ZYL

ØD h8	L	l1	Art. No.	ØD h8	L	l1	Art. No.	ØD h8	L	l1	Art. No.
2,5	57	30	4111400250	5,5	93	57	4111400550	8,5	117	75	4111400850
2,6	57	30	4111400260	5,6	93	57	4111400560	8,6	125	81	4111400860
2,7	61	33	4111400270	5,7	93	57	4111400570	8,7	125	81	4111400870
2,8	61	33	4111400280	5,8	93	57	4111400580	8,8	125	81	4111400880
2,9	61	33	4111400290	5,9	93	57	4111400590	8,9	125	81	4111400890
3,0	61	33	4111400300	6,0	93	57	4111400600	9,0	125	81	4111400900
3,1	65	36	4111400310	6,1	101	63	4111400610	9,1	125	81	4111400910
3,2	65	36	4111400320	6,2	101	63	4111400620	9,2	125	81	4111400920
3,3	65	36	4111400330	6,3	101	63	4111400630	9,3	125	81	4111400930
3,4	70	39	4111400340	6,4	101	63	4111400640	9,4	125	81	4111400940
3,5	70	39	4111400350	6,5	101	63	4111400650	9,5	125	81	4111400950
3,6	70	39	4111400360	6,6	101	63	4111400660	9,6	133	87	4111400960
3,7	70	39	4111400370	6,7	101	63	4111400670	9,7	133	87	4111400970
3,8	75	43	4111400380	6,8	109	69	4111400680	9,8	133	87	4111400980
3,9	75	43	4111400390	6,9	109	69	4111400690	9,9	133	87	4111400990
4,0	75	43	4111400400	7,0	109	69	4111400700	10,0	133	87	4111401000
4,1	75	43	4111400410	7,1	109	69	4111400710	10,2	133	87	4111401020
4,2	75	43	4111400420	7,2	109	69	4111400720	10,5	133	87	4111401050
4,3	80	47	4111400430	7,3	109	69	4111400730	10,8	142	94	4111401080
4,4	80	47	4111400440	7,4	109	69	4111400740	11,0	142	94	4111401100
4,5	80	47	4111400450	7,5	109	69	4111400750	11,2	142	94	4111401120
4,6	80	47	4111400460	7,6	117	75	4111400760	11,5	142	94	4111401150
4,7	80	47	4111400470	7,7	117	75	4111400770	11,8	142	94	4111401180
4,8	86	52	4111400480	7,8	117	75	4111400780	12,0	151	101	4111401200
4,9	86	52	4111400490	7,9	117	75	4111400790	12,2	151	101	4111401220
5,0	86	52	4111400500	8,0	117	75	4111400800	12,5	151	101	4111401250
5,1	86	52	4111400510	8,1	117	75	4111400810	12,8	151	101	4111401280
5,2	86	52	4111400520	8,2	117	75	4111400820	13,0	151	101	4111401300
5,3	86	52	4111400530	8,3	117	75	4111400830				
5,4	93	57	4111400540	8,4	117	75	4111400840				

D



- Universeller Hochleistungsbohrer
- Sehr stabil für mittlere Bohrtiefen
- Flachnutspirale und verstärkter Kern
- Spitzenanschliff ähnl. DIN 1412 B
- Oberfläche X.Cut beschichtet

- Universal high performance drill
- Very rigid for medium depth drilling
- Parabolic flutes and reinforced core
- Self centering similar DIN 1412 B
- With X.Cut coating

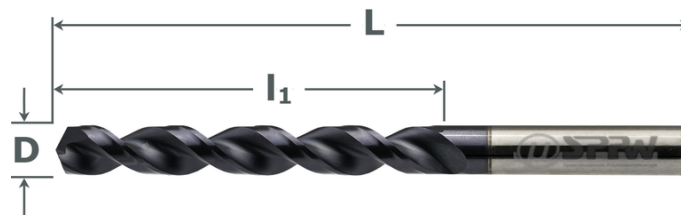

HSS E05	X Cut
DIN 338	Typ ZX
130°	ZYL



D

ØD h8	L	l1	Art. No.	ØD h8	L	l1	Art. No.	ØD h8	L	l1	Art. No.
2,5	57	30	4111470250	5,5	93	57	4111470550	8,5	117	75	4111470850
2,6	57	30	4111470260	5,6	93	57	4111470560	8,6	125	81	4111470860
2,7	61	33	4111470270	5,7	93	57	4111470570	8,7	125	81	4111470870
2,8	61	33	4111470280	5,8	93	57	4111470580	8,8	125	81	4111470880
2,9	61	33	4111470290	5,9	93	57	4111470590	8,9	125	81	4111470890
3,0	61	33	4111470300	6,0	93	57	4111470600	9,0	125	81	4111470900
3,1	65	36	4111470310	6,1	101	63	4111470610	9,1	125	81	4111470910
3,2	65	36	4111470320	6,2	101	63	4111470620	9,2	125	81	4111470920
3,3	65	36	4111470330	6,3	101	63	4111470630	9,3	125	81	4111470930
3,4	70	39	4111470340	6,4	101	63	4111470640	9,4	125	81	4111470940
3,5	70	39	4111470350	6,5	101	63	4111470650	9,5	125	81	4111470950
3,6	70	39	4111470360	6,6	101	63	4111470660	9,6	133	87	4111470960
3,7	70	39	4111470370	6,7	101	63	4111470670	9,7	133	87	4111470970
3,8	75	43	4111470380	6,8	109	69	4111470680	9,8	133	87	4111470980
3,9	75	43	4111470390	6,9	109	69	4111470690	9,9	133	87	4111470990
4,0	75	43	4111470400	7,0	109	69	4111470700	10,0	133	87	4111471000
4,1	75	43	4111470410	7,1	109	69	4111470710	10,2	133	87	4111471020
4,2	75	43	4111470420	7,2	109	69	4111470720	10,5	133	87	4111471050
4,3	80	47	4111470430	7,3	109	69	4111470730	10,8	142	94	4111471080
4,4	80	47	4111470440	7,4	109	69	4111470740	11,0	142	94	4111471100
4,5	80	47	4111470450	7,5	109	69	4111470750	11,2	142	94	4111471120
4,6	80	47	4111470460	7,6	117	75	4111470760	11,5	142	94	4111471150
4,7	80	47	4111470470	7,7	117	75	4111470770	11,8	142	94	4111471180
4,8	86	52	4111470480	7,8	117	75	4111470780	12,0	151	101	4111471200
4,9	86	52	4111470490	7,9	117	75	4111470790	12,2	151	101	4111471220
5,0	86	52	4111470500	8,0	117	75	4111470800	12,5	151	101	4111471250
5,1	86	52	4111470510	8,1	117	75	4111470810	12,8	151	101	4111471280
5,2	86	52	4111470520	8,2	117	75	4111470820	13,0	151	101	4111471300
5,3	86	52	4111470530	8,3	117	75	4111470830				
5,4	93	57	4111470540	8,4	117	75	4111470840				

411 180

Spiralbohrer HSS-E05 DIN 340 Tieflochspirale 8xØ HSS-E05 Drills DIN 340 Parabolic Flutes 8xØ



- Tiefe Bohrungen in vielen Werkstoffen
- Tieflochspirale und verstärkter Kern
- Spitzenanschliff ähnl. DIN 1412 B
- Oberfläche blank
- Deep drilling in various materials
- Parabolic flutes and reinforced core
- Self centering similar DIN 1412 B
- Bright finish



HSS E05	blank
DIN 340	Typ ZX
130°	ZYL

ØD h8	L	l1	Art. No.	ØD h8	L	l1	Art. No.	ØD h8	L	l1	Art. No.
2,0	85	56	4111800200	5,2	132	87	4111800520	8,2	165	109	4111800820
2,1	85	56	4111800210	5,3	132	87	4111800525	8,3	165	109	4111800830
2,2	90	59	4111800220	5,3	132	87	4111800530	8,4	165	109	4111800840
2,3	90	59	4111800230	5,4	139	91	4111800540	8,5	165	109	4111800850
2,4	95	62	4111800240	5,5	139	91	4111800550	8,6	175	115	4111800860
2,5	95	62	4111800250	5,6	139	91	4111800560	8,7	175	115	4111800870
2,6	95	62	4111800260	5,7	139	91	4111800570	8,8	175	115	4111800880
2,7	100	66	4111800270	5,8	139	91	4111800575	8,9	175	115	4111800890
2,8	100	66	4111800280	5,8	139	91	4111800580	9,0	175	115	4111800900
2,9	100	66	4111800290	5,9	139	91	4111800590	9,1	175	115	4111800910
3,0	100	66	4111800300	6,0	139	91	4111800600	9,2	175	115	4111800920
3,1	106	69	4111800310	6,1	148	97	4111800610	9,3	175	115	4111800930
3,2	106	69	4111800320	6,2	148	97	4111800620	9,4	175	115	4111800940
3,25	106	69	4111800325	6,3	148	97	4111800625	9,5	175	115	4111800950
3,3	106	69	4111800330	6,3	148	97	4111800630	9,6	184	121	4111800960
3,4	112	73	4111800340	6,4	148	97	4111800640	9,7	184	121	4111800970
3,5	112	73	4111800350	6,5	148	97	4111800650	9,8	184	121	4111800980
3,6	112	73	4111800360	6,6	148	97	4111800660	9,9	184	121	4111800990
3,7	112	73	4111800370	6,7	148	97	4111800670	10,0	184	121	4111801000
3,75	112	73	4111800375	6,75	156	102	4111800675	10,25	184	121	4111801025
3,8	119	78	4111800380	6,8	156	102	4111800680	10,5	184	121	4111801050
3,9	119	78	4111800390	6,9	156	102	4111800690	10,75	195	128	4111801075
4,0	119	78	4111800400	7,0	156	102	4111800700	10,8	195	128	4111801080
4,1	119	78	4111800410	7,1	156	102	4111800710	11,0	195	128	4111801100
4,2	119	78	4111800420	7,2	156	102	4111800720	11,2	195	128	4111801120
4,3	119	78	4111800425	7,3	156	102	4111800730	11,5	195	128	4111801150
4,3	126	82	4111800430	7,4	156	102	4111800740	11,8	195	128	4111801180
4,4	126	82	4111800440	7,5	156	102	4111800750	12,0	205	134	4111801200
4,5	126	82	4111800450	7,6	165	109	4111800760	12,2	205	134	4111801220
4,6	126	82	4111800460	7,7	165	109	4111800770	12,25	205	134	4111801225
4,7	126	82	4111800470	7,75	165	109	4111800775	12,5	205	134	4111801250
4,8	132	87	4111800480	7,8	165	109	4111800780	12,75	205	134	4111801275
4,9	132	87	4111800490	7,9	165	109	4111800790	12,8	205	134	4111801280
5,0	132	87	4111800500	8,0	165	109	4111800800	13,0	205	134	4111801300
5,1	132	87	4111800510	8,1	165	109	4111800810				

D

411 111**Spiralbohrer HSS-E05 Cutinox
HSS-E05 Drills Cutinox**

- Bohrer für rostfreie Stähle
- 4-Flächen-Spitzenanschliff
- Höhere Standzeiten, Schnittdaten
- Bessere Kontrolle und Genauigkeit
- Oberfläche blank
- Drill for stainless steels
- 4-facet pointfor easier drilling
- Increased tool life, cutting conditions
- Better control of dimensional accuracy
- Bright finish

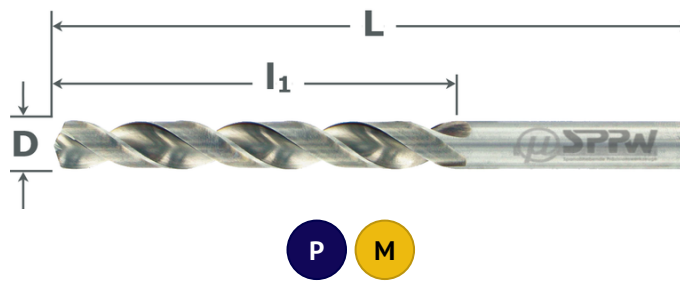

HSS E05	blank
DIN 338	Typ VA
130°	ZYL

D

ØD h8	L	l1	Art. No.	ØD h8	L	l1	Art. No.	ØD h8	L	l1	Art. No.
2,5	57	30	4111110250	5,5	93	57	4111110550	8,5	117	75	4111110850
2,6	57	30	4111110260	5,6	93	57	4111110560	8,6	125	81	4111110860
2,7	61	33	4111110270	5,7	93	57	4111110570	8,7	125	81	4111110870
2,8	61	33	4111110280	5,8	93	57	4111110580	8,8	125	81	4111110880
2,9	61	33	4111110290	5,9	93	57	4111110590	8,9	125	81	4111110890
3,0	61	33	4111110300	6,0	93	57	4111110600	9,0	125	81	4111110900
3,1	65	36	4111110310	6,1	101	63	4111110610	9,1	125	81	4111110910
3,2	65	36	4111110320	6,2	101	63	4111110620	9,2	125	81	4111110920
3,3	65	36	4111110330	6,3	101	63	4111110630	9,3	125	81	4111110930
3,4	70	39	4111110340	6,4	101	63	4111110640	9,4	125	81	4111110940
3,5	70	39	4111110350	6,5	101	63	4111110650	9,5	125	81	4111110950
3,6	70	39	4111110360	6,6	101	63	4111110660	9,6	133	87	4111110960
3,7	70	39	4111110370	6,7	101	63	4111110670	9,7	133	87	4111110970
3,8	75	43	4111110380	6,8	109	69	4111110680	9,8	133	87	4111110980
3,9	75	43	4111110390	6,9	109	69	4111110690	9,9	133	87	4111110990
4,0	75	43	4111110400	7,0	109	69	4111110700	10,0	133	87	4111111000
4,1	75	43	4111110410	7,1	109	69	4111110710	10,2	133	87	4111111020
4,2	75	43	4111110420	7,2	109	69	4111110720	10,5	133	87	4111111050
4,3	80	47	4111110430	7,3	109	69	4111110730	11,0	142	94	4111111100
4,4	80	47	4111110440	7,4	109	69	4111110740	11,5	142	94	4111111150
4,5	80	47	4111110450	7,5	109	69	4111110750	12,0	151	101	4111111200
4,6	80	47	4111110460	7,6	117	75	4111110760	12,5	151	101	4111111250
4,7	80	47	4111110470	7,7	117	75	4111110770	13,0	151	101	4111111300
4,8	86	52	4111110480	7,8	117	75	4111110780	14,0	160	108	4111111400
4,9	86	52	4111110490	7,9	117	75	4111110790	15,0	169	114	4111111500
5,0	86	52	4111110500	8,0	117	75	4111110800	16,0	178	120	4111111600
5,1	86	52	4111110510	8,1	117	75	4111110810	17,0	184	125	4111111700
5,2	86	52	4111110520	8,2	117	75	4111110820	18,0	191	130	4111111800
5,3	86	52	4111110530	8,3	117	75	4111110830	19,0	198	135	4111111900
5,4	93	57	4111110540	8,4	117	75	4111110840	20,0	205	140	4111112000

411 117

Spiralbohrer HSS-E05+X.Cut Cutinox HSS-E05 Drills+X.Cut Cutinox



- Bohrer für rostfreie Stähle
- 4-Flächen-Spitzenanschliff
- Höhere Standzeiten, Schnittdaten
- Bessere Kontrolle und Genauigkeit
- Oberfläche X.Cut beschichtet
- Drill for stainless steels
- 4-facet point for easier drilling
- Increased tool life, cutting conditions
- Better control of diametrical accuracy
- With X.Cut coating

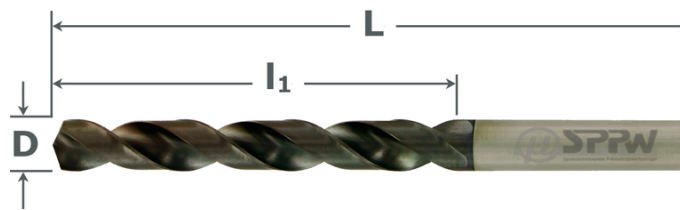

HSS E05	X Cut
DIN 338	Typ VA
130°	ZYL

ØD h8	L	l1	Art. No.	ØD h8	L	l1	Art. No.	ØD h8	L	l1	Art. No.
3,0	61	33	4111170300	5,6	93	57	4111170560	8,2	117	75	4111170820
3,1	65	36	4111170310	5,7	93	57	4111170570	8,3	117	75	4111170830
3,2	65	36	4111170320	5,8	93	57	4111170580	8,4	117	75	4111170840
3,3	65	36	4111170330	5,9	93	57	4111170590	8,5	117	75	4111170850
3,4	70	39	4111170340	6,0	93	57	4111170600	8,6	125	81	4111170860
3,5	70	39	4111170350	6,1	101	63	4111170610	8,7	125	81	4111170870
3,6	70	39	4111170360	6,2	101	63	4111170620	8,8	125	81	4111170880
3,7	70	39	4111170370	6,3	101	63	4111170630	8,9	125	81	4111170890
3,8	75	43	4111170380	6,4	101	63	4111170640	9,0	125	81	4111170900
3,9	75	43	4111170390	6,5	101	63	4111170650	9,1	125	81	4111170910
4,0	75	43	4111170400	6,6	101	63	4111170660	9,2	125	81	4111170920
4,1	75	43	4111170410	6,7	101	63	4111170670	9,3	125	81	4111170930
4,2	75	43	4111170420	6,8	109	69	4111170680	9,4	125	81	4111170940
4,3	80	47	4111170430	6,9	109	69	4111170690	9,5	125	81	4111170950
4,4	80	47	4111170440	7,0	109	69	4111170700	9,6	133	87	4111170960
4,5	80	47	4111170450	7,1	109	69	4111170710	9,7	133	87	4111170970
4,6	80	47	4111170460	7,2	109	69	4111170720	9,8	133	87	4111170980
4,7	80	47	4111170470	7,3	109	69	4111170730	9,9	133	87	4111170990
4,8	86	52	4111170480	7,4	109	69	4111170740	10,0	133	87	4111171000
4,9	86	52	4111170490	7,5	109	69	4111170750	10,2	133	87	4111171020
5,0	86	52	4111170500	7,6	117	75	4111170760	10,5	133	87	4111171050
5,1	86	52	4111170510	7,7	117	75	4111170770	11,0	142	94	4111171100
5,2	86	52	4111170520	7,8	117	75	4111170780	11,5	142	94	4111171150
5,3	86	52	4111170530	7,9	117	75	4111170790	12,0	151	101	4111171200
5,4	93	57	4111170540	8,0	117	75	4111170800	12,5	151	101	4111171250
5,5	93	57	4111170550	8,1	117	75	4111170810	13,0	151	101	4111171300

D



- Tiefbohrend in vielen Werkstoffen
- Tieflochspirale und verstärkter Kern
- Spitzenanschliff ähnl. DIN 1412 B
- Oberfläche blank
- Deep drilling in various materials
- Parabolic flutes and reinforced core
- Self centering similar DIN 1412 B
- Bright finish

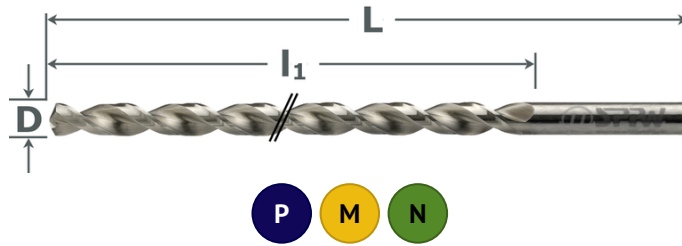

HSS E05	blank
Typ ZX	130°
ZYL	XL

411280 - OAL:125

ØD h8	L	l1	Art. No.
2,0	125	93	4112800200
2,1-2,4	125	93	411280xxxx

ØD h8	L	l1	Art. No.
2,5	125	93	4112800250
2,6-2,9	125	93	411280xxxx

ØD h8	L	l1	Art. No.
3,0	125	93	4112800300

411290 - OAL:160

ØD h8	L	l1	Art. No.
2,0	160	120	4112900200
2,1-2,4	160	120	411290xxxx
2,5	160	120	4112900250
2,6-2,9	160	120	411290xxxx
3,0	160	120	4112900300
3,1-3,4	160	120	411290xxxx

ØD h8	L	l1	Art. No.
3,5	160	120	4112900350
3,6-3,9	160	120	411290xxxx
4,0	160	120	4112900400
4,1-4,4	160	120	411290xxxx
4,5	160	120	4112900450
4,6-4,9	160	120	411290xxxx

ØD h8	L	l1	Art. No.
5,0	160	120	4112900500
5,1-5,4	160	120	411290xxxx
5,5	160	120	4112900550
5,6-5,9	160	120	411290xxxx
6,0	160	120	4112900600

411300 - OAL:200

ØD h8	L	l1	Art. No.
3,0	200	150	4113000300
3,1-3,4	200	150	411300xxxx
3,5	200	150	4113000350
3,6-3,9	200	150	411300xxxx
4,0	200	150	4113000400
4,1-4,4	200	150	411300xxxx
4,5	200	150	4113000450
4,6-4,9	200	150	411300xxxx

ØD h8	L	l1	Art. No.
5,0	200	150	4113000500
5,1-5,4	200	150	411300xxxx
5,5	200	150	4113000550
5,6-5,9	200	150	411300xxxx
6,0	200	150	4113000600
6,1-6,4	200	150	411300xxxx
6,5	200	150	4113000650
6,6-6,9	200	150	411300xxxx

ØD h8	L	l1	Art. No.
7,0	200	150	4113000700
7,1-7,4	200	150	411300xxxx
7,5	200	150	4113000750
8,0	200	150	4113000800
8,5	200	150	4113000850
9,0	200	150	4113000900
9,5	200	150	4113000950
10,0	200	150	4113001000

411310 - OAL:250

ØD h8	L	l1	Art. No.
3,0	250	187	4113100300
3,1-3,4	250	187	411310xxxx
3,5	250	187	4113100350
3,6-3,9	250	187	411310xxxx
4,0	250	187	4113100400
4,1-4,4	250	187	411310xxxx
4,5	250	187	4113100450
4,6-4,9	250	187	411310xxxx
5,0	250	187	4113100500
5,1-5,4	250	187	411310xxxx

ØD h8	L	l1	Art. No.
5,5	250	187	4113100550
5,6-5,9	250	187	411310xxxx
6,0	250	187	4113100600
6,1-6,4	250	187	411310xxxx
6,5	250	187	4113100650
6,6-6,9	250	187	411310xxxx
7,0	250	187	4113100700
7,1-7,4	250	187	411310xxxx
7,5	250	187	4113100750
8,0	250	187	4113100800

ØD h8	L	l1	Art. No.
8,5	250	187	4113100850
9,0	250	187	4113100900
9,5	250	187	4113100950
10,0	250	187	4113101000
10,5	250	187	4113101050
11,0	250	187	4113101100
11,5	250	187	4113101150
12,0	250	187	4113101200
12,5	250	187	4113101250
13,0	250	187	4113101300



- Tiefbohrend in vielen Werkstoffen
- Tieflochspirale und verstärkter Kern
- Spitzenanschliff ähnl. DIN 1412 B
- Oberfläche blank
- Deep drilling in various materials
- Parabolic flutes and reinforced core
- Self centering similar DIN 1412 B
- Bright finish

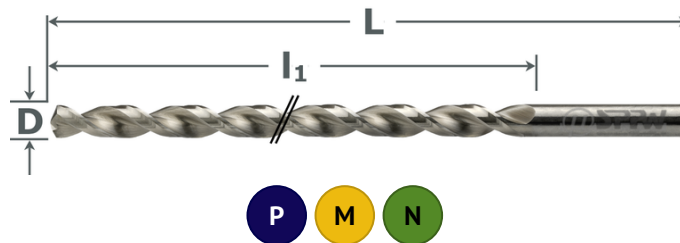

HSS E05	blank
Typ ZX	130°
ZYL	XL

411320 - OAL:315

ØD h8	L	l1	Art. No.	ØD h8	L	l1	Art. No.	ØD h8	L	l1	Art. No.
4,0	315	235	4113200400	6,1-6,4	315	235	411320xxxx	9,5	315	235	4113200950
4,1-4,4	315	235	411320xxxx	6,5	315	235	4113200650	10,0	315	235	4113201000
4,5	315	235	4113200450	6,6-6,9	315	235	411320xxxx	10,5	315	235	4113201050
4,6-4,9	315	235	411320xxxx	7,0	315	235	4113200700	11,0	315	235	4113201100
5,0	315	235	4113200500	7,1-7,4	315	235	411320xxxx	11,5	315	235	4113201150
5,1-5,4	315	235	411320xxxx	7,5	315	235	4113200750	12,0	315	235	4113201200
5,5	315	235	4113200550	8,0	315	235	4113200800	12,5	315	235	4113201250
5,6-5,9	315	235	411320xxxx	8,5	315	235	4113200850	13,0	315	235	4113201300
6,0	315	235	4113200600	9,0	315	235	4113200900				

411330 - OAL:400

ØD h8	L	l1	Art. No.	ØD h8	L	l1	Art. No.	ØD h8	L	l1	Art. No.
5,0	400	300	4113300500	7,0	400	300	4113300700	10,5	400	300	4113301050
5,1-5,4	400	300	411330xxxx	7,1-7,4	400	300	411330xxxx	11,0	400	300	4113301100
5,5	400	300	4113300550	7,5	400	300	4113300750	11,5	400	300	4113301150
5,6-5,9	400	300	411330xxxx	8,0	400	300	4113300800	12,0	400	300	4113301200
6,0	400	300	4113300600	8,5	400	300	4113300850	12,5	400	300	4113301250
6,1-6,4	400	300	411330xxxx	9,0	400	300	4113300900	13,0	400	300	4113301300
6,5	400	300	4113300650	9,5	400	300	4113300950				
6,6-6,9	400	300	411330xxxx	10,0	400	300	4113301000				

411340 - OAL:500

ØD h8	L	l1	Art. No.	ØD h8	L	l1	Art. No.	ØD h8	L	l1	Art. No.
5,0	500	450	4113400500	8,0	500	450	4113400800	11,0	500	450	4113401100
6,0	500	450	4113400600	9,0	500	450	4113400900	12,0	500	450	4113401200
7,0	500	450	4113400700	10,0	500	450	4113401000	13,0	500	450	4113401300

111 103**Spiralbohrer HSS DIN 338 Altais 5xØ
HSS Drills DIN 338 Altais 5xØ**

- Breiter Anwendungsbereich
- Profilgeschliffene Ausführung
- Selbstzentrierender Anschliff
- Oberfläche blank

- Broad field of application
- Profile ground flutes
- Self centering point
- Bright finish

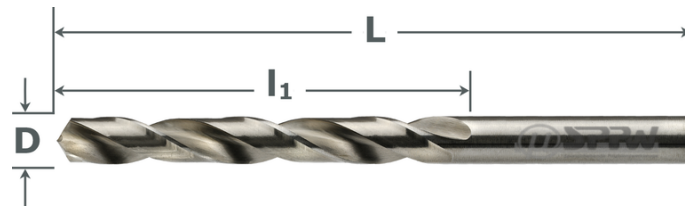

HSS	blank
DIN 338	Typ N
118°	ZYL
5xØ	

ØD h8	L	l1	Art. No.	ØD h8	L	l1	Art. No.	ØD h8	L	l1	Art. No.
0,3	19	3	1111030030	4,3	80	47	1111030430	8,3	117	75	1111030830
0,4	20	5	1111030040	4,4	80	47	1111030440	8,4	117	75	1111030840
0,5	22	6	1111030050	4,5	80	47	1111030450	8,5	117	75	1111030850
0,6	24	7	1111030060	4,6	80	47	1111030460	8,6	125	81	1111030860
0,7	28	9	1111030070	4,7	80	47	1111030470	8,7	125	81	1111030870
0,8	30	10	1111030080	4,8	86	52	1111030480	8,8	125	81	1111030880
0,9	32	11	1111030090	4,9	86	52	1111030490	8,9	125	81	1111030890
1	34	12	1111030100	5	86	52	1111030500	9	125	81	1111030900
1,1	36	14	1111030110	5,1	86	52	1111030510	9,1	125	81	1111030910
1,2	38	16	1111030120	5,2	86	52	1111030520	9,2	125	81	1111030920
1,3	38	16	1111030130	5,3	86	52	1111030530	9,3	125	81	1111030930
1,4	40	18	1111030140	5,4	93	57	1111030540	9,4	125	81	1111030940
1,5	40	18	1111030150	5,5	93	57	1111030550	9,5	125	81	1111030950
1,6	43	20	1111030160	5,6	93	57	1111030560	9,6	133	87	1111030960
1,7	43	20	1111030170	5,7	93	57	1111030570	9,7	133	87	1111030970
1,8	46	22	1111030180	5,8	93	57	1111030580	9,8	133	87	1111030980
1,9	46	22	1111030190	5,9	93	57	1111030590	9,9	133	87	1111030990
2	49	24	1111030200	6	93	57	1111030600	10	133	87	1111031000
2,1	49	24	1111030210	6,1	101	63	1111030610	10,1	133	87	1111031010
2,2	53	27	1111030220	6,2	101	63	1111030620	10,2	133	87	1111031020
2,3	53	27	1111030230	6,3	101	63	1111030630	10,3	133	87	1111031030
2,4	57	30	1111030240	6,4	101	63	1111030640	10,4	133	87	1111031040
2,5	57	30	1111030250	6,5	101	63	1111030650	10,5	133	87	1111031050
2,6	57	30	1111030260	6,6	101	63	1111030660	10,8	142	94	1111031080
2,7	61	33	1111030270	6,7	101	63	1111030670	11	142	94	1111031100
2,8	61	33	1111030280	6,8	109	69	1111030680	11,2	142	94	1111031120
2,9	61	33	1111030290	6,9	109	69	1111030690	11,5	142	94	1111031150
3	61	33	1111030300	7	109	69	1111030700	11,8	142	94	1111031180
3,1	65	36	1111030310	7,1	109	69	1111030710	12	151	101	1111031200
3,2	65	36	1111030320	7,2	109	69	1111030720	12,1	151	101	1111031210
3,3	65	36	1111030330	7,3	109	69	1111030730	12,2	151	101	1111031220
3,4	70	39	1111030340	7,4	109	69	1111030740	12,5	151	101	1111031250
3,5	70	39	1111030350	7,5	109	69	1111030750	13	151	101	1111031300
3,6	70	39	1111030360	7,6	117	75	1111030760	13,5	160	108	1111031350
3,7	70	39	1111030370	7,7	117	75	1111030770	14	160	108	1111031400
3,8	75	43	1111030380	7,8	117	75	1111030780	14,5	169	114	1111031450
3,9	75	43	1111030390	7,9	117	75	1111030790	15	169	114	1111031500
4	75	43	1111030400	8	117	75	1111030800	15,5	178	120	1111031550
4,1	75	43	1111030410	8,1	117	75	1111030810	16	178	120	1111031600
4,2	75	43	1111030420	8,2	117	75	1111030820				



- Stähle und austenitische VA-Stähle
- Profilgeschliffene Ausführung
- Selbstzentrierender Kreuzanschliff
- Spezielle Multilayer-Beschichtung
- △ Ø≤2,9 unbeschichtet, darüber C.Cut
- Steels and austenitic stainless steels
- Profile ground flutes
- Self centering split point
- Special multilayer structure
- △ Ø≤2,9 uncoated, Ø≥3 C.Cut

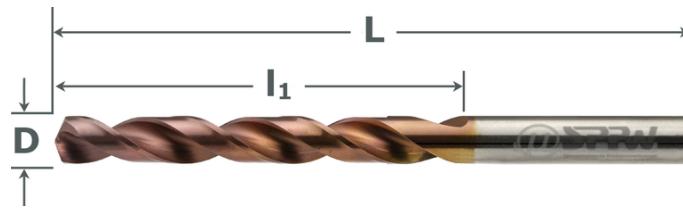

HSS	C Cut
DIN 338	Typ N
135°	ZYL
5xØ	



ØD h8	L	l1	Art. No.	ØD h8	L	l1	Art. No.	ØD h8	L	l1	Art. No.
0,5△	22	6	1111080050	4,1	75	43	1111080410	7,5	109	69	1111080750
0,6△	24	7	1111080060	4,2	75	43	1111080420	7,6	117	75	1111080760
0,7△	28	9	1111080070	4,25	75	43	1111080425	7,7	117	75	1111080770
0,8△	30	10	1111080080	4,3	80	47	1111080430	7,8	117	75	1111080780
0,9△	32	11	1111080090	4,4	80	47	1111080440	7,9	117	75	1111080790
1,0△	34	12	1111080100	4,5	80	47	1111080450	8,0	117	75	1111080800
1,1△	36	14	1111080110	4,6	80	47	1111080460	8,1	117	75	1111080810
1,2△	38	16	1111080120	4,7	80	47	1111080470	8,2	117	75	1111080820
1,3△	38	16	1111080130	4,8	86	52	1111080480	8,3	117	75	1111080830
1,4△	40	18	1111080140	4,9	86	52	1111080490	8,4	117	75	1111080840
1,5△	40	18	1111080150	5,0	86	52	1111080500	8,5	117	75	1111080850
1,6△	43	20	1111080160	5,1	86	52	1111080510	8,6	125	81	1111080860
1,7△	43	20	1111080170	5,2	86	52	1111080520	8,7	125	81	1111080870
1,8△	46	22	1111080180	5,25	86	52	1111080525	8,8	125	81	1111080880
1,9△	46	22	1111080190	5,3	86	52	1111080530	8,9	125	81	1111080890
2,0△	49	24	1111080200	5,4	93	57	1111080540	9,0	125	81	1111080900
2,1△	49	24	1111080210	5,5	93	57	1111080550	9,1	125	81	1111080910
2,2△	53	27	1111080220	5,6	93	57	1111080560	9,2	125	81	1111080920
2,3△	53	27	1111080230	5,7	93	57	1111080570	9,3	125	81	1111080930
2,4△	57	30	1111080240	5,8	93	57	1111080580	9,4	125	81	1111080940
2,5△	57	30	1111080250	5,9	93	57	1111080590	9,5	125	81	1111080950
2,6△	57	30	1111080260	6,0	93	57	1111080600	9,6	133	87	1111080960
2,7△	61	33	1111080270	6,1	101	63	1111080610	9,7	133	87	1111080970
2,8△	61	33	1111080280	6,2	101	63	1111080620	9,8	133	87	1111080980
2,9△	61	33	1111080290	6,3	101	63	1111080630	9,9	133	87	1111080990
3,0	61	33	1111080300	6,4	101	63	1111080640	10,0	133	87	1111081000
3,1	65	36	1111080310	6,5	101	63	1111080650	10,1	133	87	1111081010
3,2	65	36	1111080320	6,6	101	63	1111080660	10,2	133	87	1111081020
3,25	65	36	1111080325	6,7	101	63	1111080670	10,25	133	87	1111081025
3,3	65	36	1111080330	6,75	109	69	1111080675	10,3	133	87	1111081030
3,4	70	39	1111080340	6,8	109	69	1111080680	10,4	133	87	1111081040
3,5	70	39	1111080350	6,9	109	69	1111080690	10,5	133	87	1111081050
3,6	70	39	1111080360	7,0	109	69	1111080700	11,0	142	94	1111081100
3,7	70	39	1111080370	7,1	109	69	1111080710	11,5	142	94	1111081150
3,8	75	43	1111080380	7,2	109	69	1111080720	12,0	151	101	1111081200
3,9	75	43	1111080390	7,3	109	69	1111080730	12,5	151	101	1111081250
4,0	75	43	1111080400	7,4	109	69	1111080740	13,0	151	101	1111081300



- Breiter Anwendungsbereich
- Lange Ausführung
- Kegelmantelschliff
- Oberfläche vaporisiert
- Broad field of application
- Long series
- Conventional point
- Surface with steam treatment

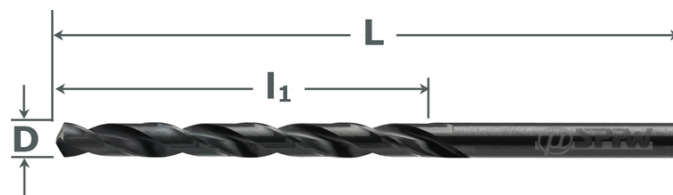

HSS	blank
DIN 340	Typ N
118°	ZYL



D

ØD h8	L	l1	Art. No.	ØD h8	L	l1	Art. No.	ØD h8	L	l1	Art. No.
1	56	33	1111300100	4	119	78	1111300400	6,75	156	102	1111300675
1,1	60	37	1111300110	4,1	119	78	1111300410	6,8	156	102	1111300680
1,2	65	41	1111300120	4,2	119	78	1111300420	7	156	102	1111300700
1,3	65	41	1111300130	4,25	119	78	1111300425	7,2	156	102	1111300720
1,4	70	45	1111300140	4,3	126	82	1111300430	7,4	156	102	1111300740
1,5	70	45	1111300150	4,4	126	82	1111300440	7,5	156	102	1111300750
1,6	76	50	1111300160	4,5	126	82	1111300450	7,8	165	109	1111300780
1,7	76	50	1111300170	4,6	126	82	1111300460	8	165	109	1111300800
1,8	80	53	1111300180	4,7	126	82	1111300470	8,1	165	109	1111300810
1,9	80	53	1111300190	4,8	132	87	1111300480	8,2	165	109	1111300820
2	85	56	1111300200	4,9	132	87	1111300490	8,25	165	109	1111300825
2,1	85	56	1111300210	5	132	87	1111300500	8,5	165	109	1111300850
2,2	90	59	1111300220	5,1	132	87	1111300510	8,6	175	115	1111300860
2,3	90	59	1111300230	5,2	132	87	1111300520	9	175	115	1111300900
2,4	95	62	1111300240	5,25	132	87	1111300525	9,5	175	115	1111300950
2,5	95	62	1111300250	5,3	132	87	1111300530	9,8	184	121	1111300980
2,6	95	62	1111300260	5,4	139	91	1111300540	10	184	121	1111301000
2,7	100	66	1111300270	5,5	139	91	1111300550	10,2	184	121	1111301020
2,8	100	66	1111300280	5,6	139	91	1111300560	10,25	184	121	1111301025
2,9	100	66	1111300290	5,7	139	91	1111300570	10,5	184	121	1111301050
3	100	66	1111300300	5,75	139	91	1111300575	11	195	128	1111301100
3,1	106	69	1111300310	5,8	139	91	1111300580	11,5	195	128	1111301150
3,2	106	69	1111300320	5,9	139	91	1111300590	12	205	134	1111301200
3,25	106	69	1111300325	6	139	91	1111300600	12,5	205	134	1111301250
3,3	106	69	1111300330	6,1	148	97	1111300610	13	205	134	1111301300
3,4	112	73	1111300340	6,2	148	97	1111300620	14	214	140	1111301400
3,5	112	73	1111300350	6,25	148	97	1111300625	15	220	144	1111301500
3,6	112	73	1111300360	6,3	148	97	1111300630	16	227	149	1111301600
3,7	112	73	1111300370	6,4	148	97	1111300640	18	241	158	1111301800
3,75	112	73	1111300375	6,5	148	97	1111300650	20	254	166	1111302000
3,8	119	78	1111300380	6,6	148	97	1111300660				
3,9	119	78	1111300390	6,7	148	97	1111300670				

111 150**Spiralbohrer HSS Links DIN 338
HSS Drills Left Hand DIN 338**

- Breiter Anwendungsbereich
- Linksschneidend für Drehmaschinen
- Kegelmantelanschleiff
- Oberfläche blank
- Broad field of application
- Left hand cutting for lathes
- Conventional point
- Bright finish

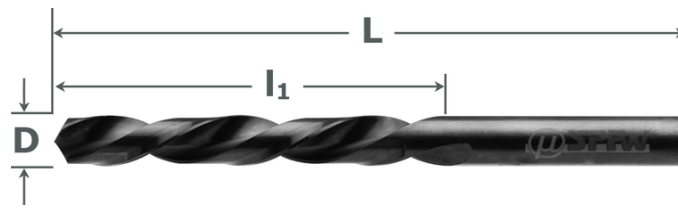

HSS	blank
DIN 338	Typ N
118°	ZYL
LH links	



ØD h8	L	l1	Art. No.
1	34	12	1111500100
1,5	40	18	1111500150
1,8	46	22	1111500180
2	49	24	1111500200
2,5	57	30	1111500250
3	61	33	1111500300
3,2	65	36	1111500320
3,3	65	36	1111500330
3,5	70	39	1111500350
4	75	43	1111500400

ØD h8	L	l1	Art. No.
4,2	75	43	1111500420
4,5	80	47	1111500450
5	86	52	1111500500
5,2	86	52	1111500520
5,5	93	57	1111500550
6	93	57	1111500600
6,2	101	63	1111500620
6,5	101	63	1111500650
6,8	109	69	1111500680
7	109	69	1111500700

ØD h8	L	l1	Art. No.
7,5	109	69	1111500750
8	117	75	1111500800
8,5	117	75	1111500850
9	125	81	1111500900
9,5	125	81	1111500950
10	133	87	1111501000
11	142	94	1111501100
12	151	101	1111501200

111 500

Spiralbohrer HSS+Steam DIN 345 mit MK-Schaft HSS Drills+Steam DIN 345 with Morse Taper Shank



- Breiter Anwendungsbereich
- Standardausführung mit MK- Schaft
- Kegelmantelanschliff gem. DIN 1412
- Oberfläche vaporisiert
- Broad field of application
- Standard drill with MTS
- Conventional point acc. to DIN 1412
- Surface with steam treatment

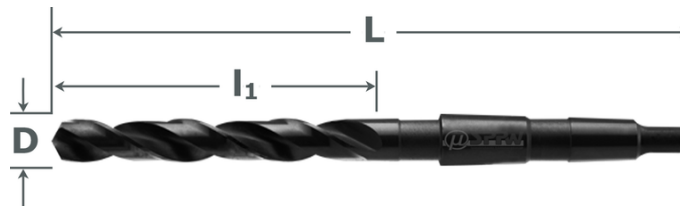

HSS	VAP
DIN 345	Typ N
118°	MK MTS
5xØ	

ØD h8	L	l1	MK MTS	Art. No.	ØD h8	L	l1	MK MTS	Art. No.
10	168	87	1	1115001000	18,75	233	135	2	1115001875
10,25	168	87	1	1115001025	19	233	135	2	1115001900
10,5	168	87	1	1115001050	19,25	238	140	2	1115001925
10,75	175	94	1	1115001075	19,5	238	140	2	1115001950
11	175	94	1	1115001100	19,75	238	140	2	1115001975
11,25	175	94	1	1115001125	20	238	140	2	1115002000
11,5	175	94	1	1115001150	20,25	243	145	2	1115002025
11,75	175	94	1	1115001175	20,5	243	145	2	1115002050
12	182	101	1	1115001200	20,75	243	145	2	1115002075
12,25	182	101	1	1115001225	21	243	145	2	1115002100
12,5	182	101	1	1115001250	21,25	248	150	2	1115002125
12,75	182	101	1	1115001275	21,5	248	150	2	1115002150
13	182	101	1	1115001300	21,75	248	150	2	1115002175
13,25	189	108	1	1115001325	22	248	150	2	1115002200
13,5	189	108	1	1115001350	22,25	248	150	2	1115002225
13,75	189	108	1	1115001375	22,5	253	155	2	1115002250
14	189	108	1	1115001400	22,75	253	155	2	1115002275
14,25	212	114	2	1115001425	23	253	155	2	1115002300
14,5	212	114	2	1115001450	23,25	276	155	3	1115002325
14,75	212	114	2	1115001475	23,5	276	155	3	1115002350
15	212	114	2	1115001500	23,75	281	160	3	1115002375
15,25	218	120	2	1115001525	24,25	281	160	3	1115002425
15,5	218	120	2	1115001550	24,5	281	160	3	1115002450
15,75	218	120	2	1115001575	25	281	160	3	1115002500
16	218	120	2	1115001600	25,5	286	165	3	1115002550
16,25	223	125	2	1115001625	26	286	165	3	1115002600
16,5	223	125	2	1115001650	26,5	286	165	3	1115002650
16,75	223	125	2	1115001675	27	291	170	3	1115002700
17	223	125	2	1115001700	27,5	291	170	3	1115002750
17,25	228	130	2	1115001725	28	291	170	3	1115002800
17,5	228	130	2	1115001750	28,5	296	175	3	1115002850
17,75	228	130	2	1115001775	29	296	175	3	1115002900
18	228	130	2	1115001800	29,5	296	175	3	1115002950
18,25	233	135	2	1115001825	30	296	175	3	1115003000
18,5	233	135	2	1115001850	30,5	301	180	3	1115003050

111 500

Spiralbohrer HSS+Steam DIN 345 mit MK-Schaft HSS Drills+Steam DIN 345 with Morse Taper Shank



- Breiter Anwendungsbereich
- Standardausführung mit MK- Schaft
- Kegelmantelanschliff gem. DIN 1412
- Oberfläche vaporisiert
- Broad field of application
- Standard drill with MTS
- Conventional point acc. to DIN 1412
- Surface with steam treatment

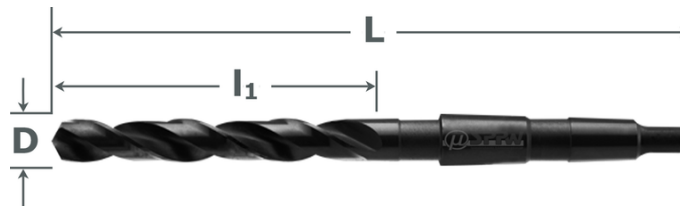

HSS	VAP
DIN 345	Typ N
118°	MK MTS
5xØ	

D

ØD h8	L	l1	MK MTS	Art. No.	ØD h8	L	l1	MK MTS	Art. No.
31	301	180	3	1115003100	53	412	225	5	1115005300
31,5	301	180	3	1115003150	54	417	230	5	1115005400
32	334	185	4	1115003200	55	417	230	5	1115005500
33	334	185	4	1115003300	56	417	230	5	1115005600
34	339	190	4	1115003400	57	422	235	5	1115005700
35	339	190	4	1115003500	58	422	235	5	1115005800
36	344	195	4	1115003600	59	422	235	5	1115005900
37	334	195	4	1115003700	60	422	235	5	1115006000
38	349	200	4	1115003800	61	427	240	5	1115006100
39	349	200	4	1115003900	62	427	240	5	1115006200
40	349	200	4	1115004000	63	427	240	5	1115006300
41	354	205	4	1115004100	64	432	245	5	1115006400
42	354	205	4	1115004200	65	432	245	5	1115006500
43	359	210	4	1115004300	66	432	245	5	1115006600
44	359	210	4	1115004400	67	432	245	5	1115006700
45	359	210	4	1115004500	68	437	250	5	1115006800
46	364	215	4	1115004600	69	437	250	5	1115006900
47	364	215	4	1115004700	70	437	250	5	1115007000
48	369	220	4	1115004800	71	437	250	5	1115007100
49	369	220	4	1115004900	72	442	255	5	1115007200
50	369	220	4	1115005000	73	442	255	5	1115007300
51	412	225	5	1115005100	74	442	255	5	1115007400
52	412	225	5	1115005200	75	442	255	5	1115007500

— INFO**L - XL - XXL: Lange + Überlange Spiralbohrer | Long and Extra Long Drills**

Spiralbohrer nach DIN 341, DIN 1870 oder NFE 66067 auf Anfrage
Drills according to DIN 341, DIN 1870 or NFE 66067 on request





Spanabhebende Präzisionswerkzeuge

[DE] **Reiben**

[EN] **Reaming**



passion for precision

[Leidenschaft für Präzision]



Reibahlen HSS-E05 1/100

HSS-E05 Machine Reamers 1/100

Art.No./Page

● ● ● ○		HSS E05	blank	DIN 212	Form B	1/100	z: 4-8	ZYL	113 270 Seite E 11
● ● ● ○		HSS E05	blank	DIN 212	Form B	SPX TOL	ZYL	1/100	113 181 Seite E 12
● ● ● ○		HSS E05	blank	DIN 208	Form B	SPX 1/100	MK MTS		113 199 Seite E 13

Reibahlen HSS-E05 H7

HSS-E05 Machine Reamers H7

Art.No./Page

● ● ● ○		HSS E05	blank	DIN 212	Form B	H7	z: 4-8	ZYL	113 180 Seite E 14
● ● ● ● ●		HSS E05	X Cut	DIN 212	Form B	H7	z: 4-8	ZYL	113 187 Seite E 15
● ● ● ○		HSS E05	blank	DIN 208	Form B	H7	MK MTS		113 190 Seite E 16
● ● ● ○		HSS E05	blank	Form B	H7	ZYL	L lang		513 110 Seite E 17
● ● ● ○		HSS E05	blank	Form B	H7	ZYL	XL		513 120 Seite E 17
● ● ● ○		HSS E05	blank	Form B	H7	MK MTS	L lang		514 110 Seite E 18
● ● ● ○		HSS E05	blank	Form B	H7	MK MTS	XL		514 120 Seite E 18
● ● ●		HSS E05	blank	DIN 212	Form A	H7	ZYL		113 160 Seite E 19
● ● ●		HSS E05	blank	DIN 208	Form A	H7	MK MTS		113 200 Seite E 19
● ● ●		HSS E05	blank	DIN 212	Form C	H7	ZYL		113 170 Seite E 20
● ● ●		HSS E05	blank	DIN 208	Form C	H7	MK MTS		113 210 Seite E 20

Kegelreibahlen HSS /-E

HSS / HSS-E05 Taper Machine Reamers

Art.No./Page

● ● ● ○		HSS E05	blank	Form C	z:5	ZYL	Konus 5%-10%		114 740 Seite E 21
● ● ● ○		HSS E05	blank	DIN 9	Form A	Hand	1:50 2%		114 700 Seite E 22
● ● ● ○		HSS	blank	Form C	MK MTS	for MTS			114 780 Seite E 22
● ● ● ○		HSS	blank	Form B	Hand	1:16 6,25%			114 785 Seite E 23

Handreibahlen HSS + VHM

Hand Reamers

Art.No./Page

		VHM	blank	Form B	H7	z:6	ZYL	Hand	613 150 Seite E 23
		HSS	blank	DIN 206	Form B	H7	HAND	113 150 Seite E 24	

— INFO —

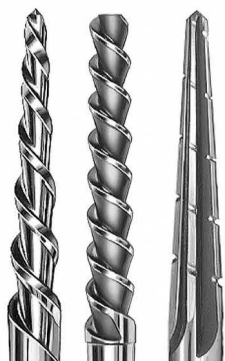

Sonderanfertigungen - Sonderpassungen

Unser Lager an halbfertigen Rohlingen erlaubt es uns kurzfristig eine Vielzahl von Passungs- und Sonderreibahlen zu fertigen. **Frage Sie an!**

Special productions - Special Fits

Our stock of semi-finished blanks allows us to produce a wide range of special reamers and special tolerances at short notice.



613 610**Micro-Präzisionsreibahlen VHM 5/1000 steigend
Carbide Precision Micro Reamers 5/1000 increments**

- Toleranz $\pm 0,001$ ($\pm 1\mu\text{m}$)
- Reiben von Durchgangsbohrungen
- 20° Linksspirale, rechtsschneidend
- Verstärkter Schaft $\text{\O}3$ h5
- 0,005 ($5\mu\text{m}$) steigend
- Oberfläche poliert

- Tolerance $\pm 0,001$ ($\pm 1\mu\text{m}$)
- Reaming through holes
- 20° LH-helix, right hand cutting
- Reinforced shank $\text{\O}3$ h5
- 0,005 ($5\mu\text{m}$) increments
- Polished finish

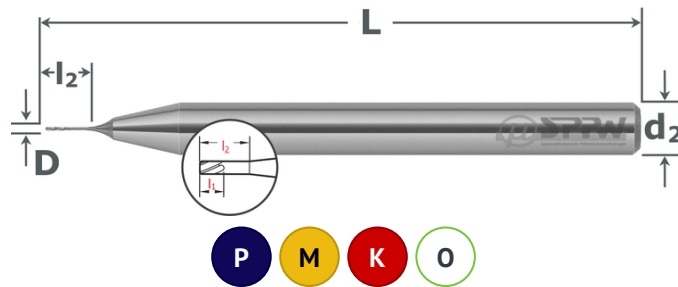

VHM	poliert
Form B	0,005 $5\mu\text{m}$
z:4	Schaft 3h5

0,005 steigend | 5 μm increments

$\text{\O}D$ $\pm 1\mu$	$\text{\O}d2$ h5	L	l1	l2	z	Art. No.
0,200-0,245	3	39	0,9	2	4	613610xxxx
0,250-0,295	3	39	1,1	2,5	4	613610xxxx
0,300-0,345	3	39	1,4	3	4	613610xxxx

$\text{\O}D$ $\pm 1\mu$	$\text{\O}d2$ h5	L	l1	l2	z	Art. No.
0,350-0,395	3	39	1,7	3,5	4	613610xxxx
0,400-0,495	3	39	2	4	4	613610xxxx
0,500-0,595	3	39	2,3	5	4	613610xxxx

E**613 610****Micro-Präzisionsreibahlen VHM 1/100 steigend
Carbide Precision Micro Reamers 1/100 increments**

- Toleranz $\pm 0,001$ ($1\mu\text{m}$)
- Reiben von Durchgangsbohrungen
- 20° Linksspirale, rechtsschneidend
- Verstärkter Schaft $\text{\O}3$ h5
- 1/100 steigend
- Oberfläche poliert

- Tolerance $\pm 0,001$ ($1\mu\text{m}$)
- Reaming through holes
- 20° LH-helix, right hand cutting
- Reinforced shank $\text{\O}3$ h5
- 1/100 increments
- Polished finish

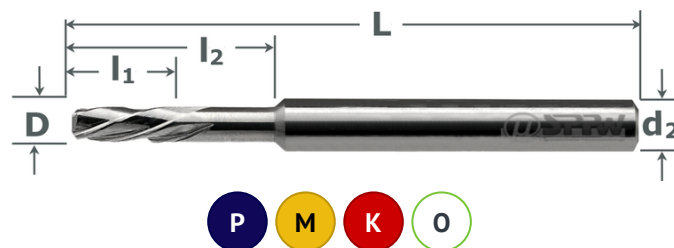

VHM	poliert
Form B	1/100
z:4	Schaft 3h5

1/100 steigend | 1/100 increments

$\text{\O}D$ $\pm 1\mu$	$\text{\O}d2$ h5	L	l1	l2	z	Art. No.
0,60-0,69	3	39	2,6	6	4	613610xxxx
0,70-0,79	3	39	3	7	4	613610xxxx
0,80-0,94	3	39	3,8	8,5	4	613610xxxx
0,95-1,05	3	39	3,8	8,5	4	613610xxxx
1,06-1,25	3	50	4,7	10,5	4	613610xxxx

$\text{\O}D$ $\pm 1\mu$	$\text{\O}d2$ h5	L	l1	l2	z	Art. No.
1,26-1,45	3	50	5,5	12	4	613610xxxx
1,46-1,65	3	50	6,3	14	4	613610xxxx
1,66-1,85	3	50	7	16	4	613610xxxx
1,86-1,94	3	50	8	17,5	4	613610xxxx
1,95-2,05	3	50	8	17,5	4	613610xxxx



- Anschnitt 45°
- Linkspirale, rechtsschneidend
- Ab Ø13,97 mit Hartmetallkopf
- Oberfläche blank
- Toleranzen:
 $\emptyset \leq 3$ +0,003, $\emptyset \leq 6$ +0,004, $\emptyset > 6$ +0,005
- Chamfer 45°
- LH-helix, right hand cutting
- From Ø13,97 with carbide head
- Bright finish
- Tolerances:
 $\emptyset \leq 3$ +0,003, $\emptyset \leq 6$ +0,004, $\emptyset > 6$ +0,005

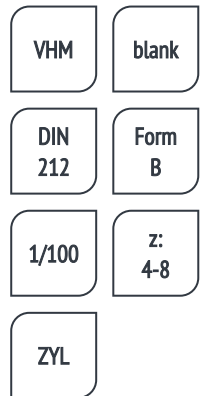
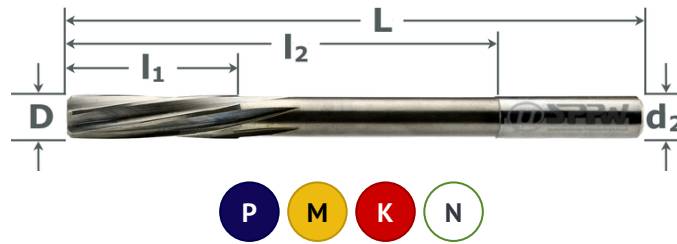

E

ØD	Ød2 h6	L	l1	l2	z	Art. No.	ØD	Ød2 h6	L	l1	l2	z	Art. No.
0,60-0,69	D	33	7	17	4	613270xxxx	6,71-6,95	7	109	31	80	6	613270xxxx
0,70-0,79	D	33	7	17	4	613270xxxx	6,96-7,04	7	109	31	80	6	613270xxxx
0,80-0,95	D	38	7	22	4	613270xxxx	7,05-7,55	7	109	31	80	6	613270xxxx
0,96-1,05	D	38	7	22	4	613270xxxx	7,56-7,95	8	117	33	86	6	613270xxxx
1,06-1,47	D	40	10	24	4	613270xxxx	7,96-8,04	8	117	33	86	6	613270xxxx
1,48-1,55	D	40	10	24	4	613270xxxx	8,05-8,55	8	117	33	86	6	613270xxxx
1,56-1,79	D	43	11	26	4	613270xxxx	8,56-8,95	9	125	36	91	6	613270xxxx
1,80-1,94	D	49	12	31	4	613270xxxx	8,96-9,04	9	125	36	91	6	613270xxxx
1,95-2,04	D	49	12	31	4	613270xxxx	9,05-9,55	9	125	36	91	6	613270xxxx
2,05-2,36	D	49	12	31	4	613270xxxx	9,56-9,95	10	133	38	99	6	613270xxxx
2,37-2,94	D	57	18	38	6	613270xxxx	9,96-10,04	10	133	38	99	6	613270xxxx
2,95-3,04	D	57	18	38	6	613270xxxx	10,05-10,95	10	133	38	99	6	613270xxxx
3,05-3,75	D	57	18	38	6	613270xxxx	10,96-11,04	10	133	38	99	6	613270xxxx
3,76-3,94	4	75	19	51	6	613270xxxx	11,05-11,30	10	133	38	99	6	613270xxxx
3,95-4,04	4	75	19	51	6	613270xxxx	11,31-11,95	12	151	44	106	6	613270xxxx
4,05-4,25	4	75	19	51	6	613270xxxx	11,96-12,04	12	151	44	106	6	613270xxxx
4,26-4,53	4,5	80	21	55	6	613270xxxx	12,05-12,95	12	151	44	106	6	613270xxxx
4,54-4,75	4,5	80	21	55	6	613270xxxx	12,96-13,05	12	151	44	106	6	613270xxxx
4,76-4,95	5	86	23	60	6	613270xxxx	13,97-14,05	14	160	47	110	8	613270xxxx
4,96-5,04	5	86	23	60	6	613270xxxx	14,97-15,05	14	162	50	112	8	613270xxxx
5,05-5,30	5	86	23	60	6	613270xxxx	15,97-16,05	16	170	52	117	8	613270xxxx
5,31-5,80	5,5	93	26	66	6	613270xxxx	16,97-17,05	16	175	54	122	8	613270xxxx
5,81-5,95	6	101	28	73	6	613270xxxx	17,97-18,05	16	182	56	129	8	613270xxxx
5,96-6,04	6	101	28	73	6	613270xxxx	18,97-19,05	16	189	58	136	8	613270xxxx
6,05-6,70	6	101	28	73	6	613270xxxx	19,97-20,05	16	195	60	142	8	613270xxxx



- 1/100 und Passungen nach Vorgabe
- Anschnitt 45°, Durchgangsbohrungen
- Linksspirale, rechtsschneidend
- Oberfläche blank
- Lieferzeit ca. 5-8 Arbeitstage
- Sonderanfertigung, kein Umtausch
- Centesimal and special fit reamers
- Chamfer 45°, reaming through holes
- LH-helix, RH-cutting
- Bright finish
- Delivery time 5-8 work days
- Special production, no returns

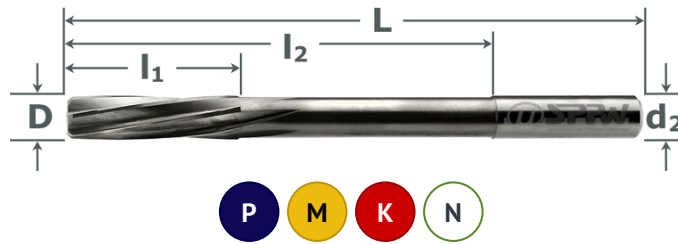

VHM	blank
DIN 212	Form B
SPX special	z:6
ZYL	1/100

ØD ±0,004	Ød2 h8	L	l1	l2	z	Art. No.
4,06-4,55	4,5	80	21	47	6	6131810406
4,56-5,05	5	86	23	52	6	6131810456
5,06-5,55	6	93	26	57	6	6131810506
5,56-6,05	6	93	26	57	6	6131810556
6,56-7,05	7	109	31	69	6	6131810656
7,06-7,55	7	109	31	69	6	6131810706
7,56-8,05	8	117	33	75	6	6131810756
8,06-8,55	8	117	33	75	6	6131810806

ØD ±0,004	Ød2 h8	L	l1	l2	z	Art. No.
8,56-9,05	9	125	36	81	6	6131810856
9,06-9,55	9	125	36	81	6	6131810906
9,56-10,05	10	133	38	87	6	6131810956
10,06-10,5	10	133	38	87	6	6131811006
10,56-11,0	10	142	41	96	6	6131811056
11,06-11,5	10	142	41	96	6	6131811106
11,56-12,0	12	151	44	105	6	6131811156

E

— INFO —

Formen von Reibahlen | Forms of Reamers

<p>Form A</p>	<p>Gerade genutet, rechtsschneidend</p> <ul style="list-style-type: none"> - zum Reiben von Grund- und Durchgangsbohrungen - Verfügbar als Hartreibahle oder mit Innenkühlung <p>Straight Flutes, RH-cutting</p> <ul style="list-style-type: none"> - reaming of ground holes and through holes - also available for hardened steels and with IC 	<p>Form B</p>	<p>Linksspirale, rechtsschneidend</p> <ul style="list-style-type: none"> - zum Reiben von Durchgangsbohrungen - große Auswahl, insbesondere Hundertstel <p>LH-Helix, RH-cutting</p> <ul style="list-style-type: none"> - reaming through holes - wide range, especially centesimals
<p>Form C</p>	<p>Linksspirale, rechtsschneidend</p> <ul style="list-style-type: none"> - zum Reiben von Durchgangsbohrungen - große Spanräume, erhöhte Schnittgeschwindigkeit - besonders für langspanende Werkstoffe geeignet <p>LH-High-Helix, RH-cutting</p> <ul style="list-style-type: none"> - reaming through holes in softer materials - increased reaming speed 	<p>Form D</p>	<p>Rechtsspirale, rechtsschneidend</p> <ul style="list-style-type: none"> - Zum Reiben von Grundbohrungen - Spanauswurf nach oben - auch mit Stirnanschnitt lieferbar <p>RH-Helix, RH-cutting</p> <ul style="list-style-type: none"> - reaming of ground holes, chip evacuation to top - also available with frontal cut

613 189

Reibahlen mit HM-Schneidplatten 1/100 steigend Carbide Tipped Machine Reamers 1/100 increments



- Anschnitt 45°
 - Reiben von Durchgangsbohrungen
 - Linksspirale, rechtsschneidend
 - Oberfläche blank
- △ SONDER: Lieferzeit 5-8 Arbeitstage, keine Rücknahme. Staffelpreise!

- Chamfer 45°
 - Reaming through holes
 - Left hand helix, right hand cutting
 - Bright finish
- △ SPECIAL: Delivery time 5-8 working days. No returns. Scaled prices.

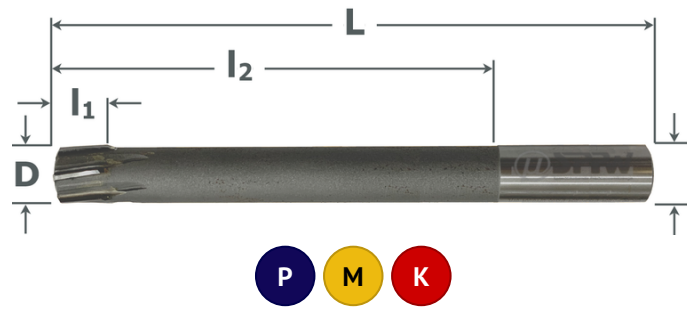

HMP	blank
Form B	1/100
z: 6-8	ZYL

E

ØD +0,004	Ød2 h6	L	l1	l2	z	Art. No.
12,21-13,20	12	120	19	75	6	613189xxxx
13,21-14,20	12	120	19	75	6	613189xxxx
14,21-15,20	14	130	19	85	6	613189xxxx
15,21-16,20	14	130	22	85	6	613189xxxx
16,21-18,20	16	150	22	102	6	613189xxxx
18,21-19,20	16	150	22	102	6	613189xxxx
19,21-20,20	16	150	22	102	6	613189xxxx
20,21-22,20	20	160	25	110	6	613189xxxx
22,21-23,20	20	180	25	130	6	613189xxxx
23,21-24,20	20	180	25	130	8	613189xxxx
24,21-25,20	20	180	25	130	8	613189xxxx

ØD +0,004	Ød2 h6	L	l1	l2	z	Art. No.
25,21-26,20	25	180	25	124	8	613189xxxx
26,21-28,20	25	180	30	124	8	613189xxxx
28,21-29,20	25	200	30	144	8	613189xxxx
29,21-30,20	25	200	30	144	8	613189xxxx
30,21-31,20	25	200	30	144	8	613189xxxx
31,21-32,20	25	200	30	144	8	613189xxxx
32,21-33,20	32	200	30	140	8	613189xxxx
33,21-34,20	32	200	30	140	8	613189xxxx
34,21-36,20	32	200	30	140	8	613189xxxx
36,21-38,20	32	200	30	140	8	613189xxxx
38,21-40,20	32	200	30	140	8	613189xxxx

613 199

Reibahlen mit HM-Schneidplatten 1/100 steigend Carbide Tipped Machine Reamers 1/100 increments



- Anschnitt 45° Durchgangsbohrungen
 - Linksspirale, rechtsschneidend
 - Oberfläche blank
 - Toleranz 0/+0,005
- △ SONDER: Lieferzeit 5-8 Arbeitstage, keine Rücknahme. Staffelpreise!

- Chamfer 45° reaming through holes
 - LH-helix, right hand cutting
 - Bright finish
 - Tolerance 0/+0,005
- △ SPECIAL: Delivery time 5-8 working days. No returns. Scaled prices!

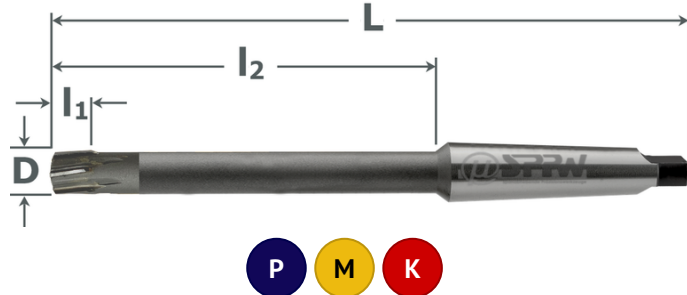

HMP	blank
Form B	1/100
z: 6-8	MK MTS

ØD +0,004	L	l1	l2	z	MK Nr.	Art. No.
9,50-10,20	168	19	102	6	1	613199xxxx
10,21-12,20	175	19	109	6	1	613199xxxx
12,21-13,20	182	19	116	6	1	613199xxxx
13,21-14,20	189	19	123	6	1	613199xxxx
14,21-15,20	204	19	124	6	2	613199xxxx
15,21-16,20	210	22	130	6	2	613199xxxx
16,21-17,20	214	22	134	6	2	613199xxxx
17,21-18,20	219	22	139	6	2	613199xxxx
18,21-20,20	223	22	143	6	2	613199xxxx
18,21-19,20	223	22	143	6	2	613199xxxx
19,21-20,20	228	22	148	6	2	613199xxxx

ØD +0,004	L	l1	l2	z	MK Nr.	Art. No.
20,21-21,20	232	25	152	6	2	613199xxxx
21,21-23,20	237	25	157	6	2	613199xxxx
23,21-24,20	268	25	169	8	3	613199xxxx
24,21-25,20	268	25	169	8	3	613199xxxx
25,21-26,20	273	25	174	8	3	613199xxxx
26,21-27,20	277	30	178	8	3	613199xxxx
27,21-28,20	277	30	178	8	3	613199xxxx
28,21-29,20	281	30	182	8	3	613199xxxx
29,21-30,20	281	30	182	8	3	613199xxxx
30,21-31,20	285	30	186	8	3	613199xxxx
31,21-32,20	290	30	191	8	3	613199xxxx

E 4



- Anschnitt 45°, Durchgangsbohrungen
- Toleranz H7
- Linksspirale, rechtsschneidend
- Ab Ø14 mit Hartmetallkopf
- Oberfläche blank

- Chamfer 45°, reaming through holes
- Tolerance H7
- LH-helix, right hand cutting
- Above Ø14 with carbide head
- Bright finish

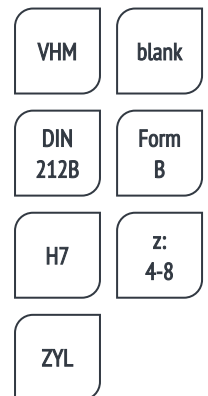
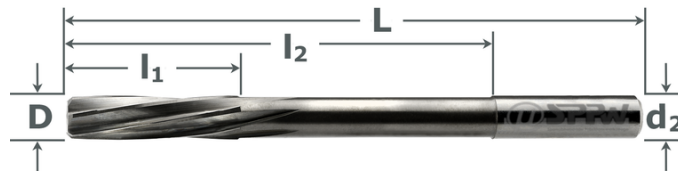

ØD H7	Ød2 h7	L	l1	l2	z	Art. No.	ØD H7	Ød2 h7	L	l1	l2	z	Art. No.
1	1	38	7	22	4	6131800100	4,5	4,5	80	21	55	6	6131800450
1,1	1,1	40	10	24	4	6131800110	4,6	4,5	80	21	55	6	6131800460
1,2	1,2	40	10	24	4	6131800120	4,7	4,5	80	21	55	6	6131800470
1,3	1,3	40	10	24	4	6131800130	4,8	5	86	23	60	6	6131800480
1,4	1,4	40	10	24	4	6131800140	4,9	5	86	23	60	6	6131800490
1,5	1,5	40	10	24	4	6131800150	5	5	86	23	60	6	6131800500
1,6	1,6	43	11	25	4	6131800160	5,1	5	86	23	60	6	6131800510
1,7	1,7	43	11	25	4	6131800170	5,2	5	86	23	60	6	6131800520
1,8	1,8	49	12	31	4	6131800180	5,3	5	86	23	60	6	6131800530
1,9	1,9	49	12	31	4	6131800190	5,4	5,5	93	26	66	6	6131800540
2	2	49	12	31	4	6131800200	5,5	5,5	93	26	66	6	6131800550
2,1	2,1	49	12	31	4	6131800210	5,6	5,5	93	26	66	6	6131800560
2,2	2,2	49	12	31	4	6131800220	5,7	5,5	93	26	66	6	6131800570
2,3	2,3	49	12	31	4	6131800230	5,8	5,5	93	26	66	6	6131800580
2,4	2,4	57	18	38	6	6131800240	5,9	6	101	28	73	6	6131800590
2,5	2,5	57	18	38	6	6131800250	6	6	101	28	73	6	6131800600
2,6	2,6	57	18	38	6	6131800260	6,5	6	101	28	73	6	6131800650
2,7	2,7	57	18	38	6	6131800270	7	7	109	31	80	6	6131800700
2,8	2,8	57	18	38	6	6131800280	7,5	7	109	31	80	6	6131800750
2,9	2,9	57	18	38	6	6131800290	8	8	117	33	86	6	6131800800
3	3	57	18	38	6	6131800300	8,5	8	117	33	86	6	6131800850
3,1	3,1	57	18	38	6	6131800310	9	9	125	36	91	6	6131800900
3,2	3,2	57	18	38	6	6131800320	9,5	9	125	36	91	6	6131800950
3,3	3,3	57	18	38	6	6131800330	10	10	133	38	99	6	6131801000
3,4	3,4	57	18	38	6	6131800340	10,5	10	133	38	99	6	6131801050
3,5	3,5	57	18	38	6	6131800350	11	10	133	38	99	6	6131801100
3,6	3,6	57	18	38	6	6131800360	11,5	12	151	44	106	6	6131801150
3,7	3,7	57	18	38	6	6131800370	12	12	151	44	106	6	6131801200
3,8	4	75	19	51	6	6131800380	12,5	12	151	44	106	6	6131801250
3,9	4	75	19	51	6	6131800390	14	14	160	47	110	8	6131801400
4	4	75	19	51	6	6131800400	15	14	162	50	112	8	6131801500
4,1	4	75	19	51	6	6131800410	16	16	170	52	117	8	6131801600
4,2	4	75	19	51	6	6131800420	18	16	182	56	129	8	6131801800
4,3	4,5	80	21	55	6	6131800430	20	16	195	60	142	8	6131802000
4,4	4,5	80	21	55	6	6131800440							

613 615

Maschinen-Stirnreibahlen VHM H7 Carbide Machine Reamers with Front Cut H7



- Stirnschneidend, Rechtsdrall
- Toleranz H7
- Reiben von Grundlöchern
- Positionskorrektur vorhandener Löcher
- Oberfläche blank
- Frontal cut, RH-helix
- Tolerance H7
- Use to machine blind holes
- Straighten and ream primary holes
- Bright finish

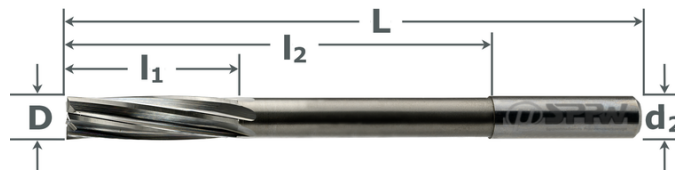

VHM	blank
DIN 212	Form D
H7	z: 4-6
ZYL	Front Cut

E

ØD H7	Ød2 h6	L	l1	l2	z	Art. No.
3	3	57	15	38	4	6136150300
4	4	75	19	49	6	6136150400
4,5	4,5	80	21	51	6	6136150450
5	5	86	23	59	6	6136150500
5,5	5,5	93	26	65	6	6136150550
6	6	101	28	71	6	6136150600

ØD H7	Ød2 h6	L	l1	l2	z	Art. No.
7	7	109	31	78	6	6136150700
8	8	117	33	84	6	6136150800
9	9	125	36	88	6	6136150900
10	10	133	38	97	6	6136151000
12	12	151	44	110	6	6136151200

613 620

NC-Maschinenreibahlen VHM H7 Carbide NC Machine Reamers H7



- Toleranz H7
- Reiben von Durchgangsbohrungen
- 10° Linksspirale, rechtsschneidend
- Einheitsschaft Toleranz h6
- Oberfläche blank
- Tolerance H7
- Reaming through holes
- 10° left hand helix, right hand cutting
- Shank for hydraulic or shrink fit
- Bright finish

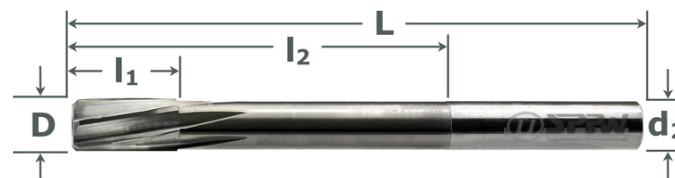

VHM	blank
NC short	Form B
H7	z: 6-8
DIN 6535HA	

ØD H7	Ød2 h6	L	l1	l2	z	Art. No.
4	4	60	16	35	6	6136200400
4,5	5	70	16	45	6	6136200450
5	5	70	16	45	6	6136200500
5,5	6	80	16	55	6	6136200550
6	6	80	16	55	6	6136200600
7	8	90	18	60	6	6136200700
8	8	90	18	60	6	6136200800
9	8	90	18	60	6	6136200900
10	10	115	20	75	6	6136201000

ØD H7	Ød2 h6	L	l1	l2	z	Art. No.
11	10	115	20	75	6	6136201100
12	12	130	20	80	6	6136201200
13	12	130	20	80	8	6136201300
14	12	130	20	80	8	6136201400
15	12	130	20	80	8	6136201500
16	16	140	25	90	8	6136201600
18	16	140	25	90	8	6136201800
20	16	140	25	90	8	6136202000



- Anschnitt 45°
 - NC-Schaft Toleranz h6
 - Grund- und Durchgangsbohrungen
 - Geradegenutet, rechtsschneidend
 - Gehärtete Werkstoffe bis 65 HRC
 - Oberfläche X.Cut beschichtet
 - Lieferzeit 3 - 5 Arbeitstage
-
- Chamfer 45°
 - Straight shank tolerance h6
 - Reaming of blind- and through holes
 - Straight flutes, right hand cutting
 - Hardened steels up to 65 HRC
 - With X.Cut coating
 - Delivery time 3 - 5 working days

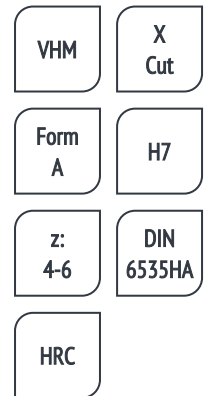
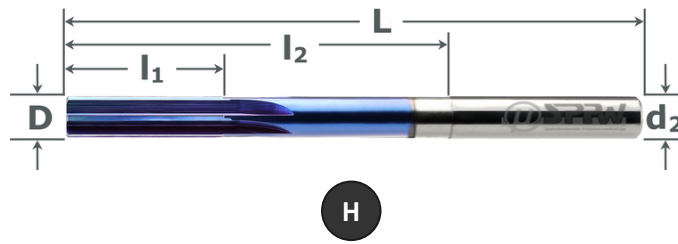

ØD H7	Ød2 h6	L	l1	l2	z	Art. No.	ØD H7	Ød2 h6	L	l1	l2	z	Art. No.
1,97	3	60	15	30	4	6132900197	5,02	6	100	26	60	6	6132900502
1,98	3	60	15	30	4	6132900198	5,03	6	100	26	60	6	6132900503
1,99	3	60	15	30	4	6132900199	5,96	6	100	26	60	6	6132900596
2	3	60	15	30	4	6132900200	5,97	6	100	26	60	6	6132900597
2,01	3	60	15	30	4	6132900201	5,98	6	100	26	60	6	6132900598
2,02	3	60	15	30	4	6132900202	5,99	6	100	26	60	6	6132900599
2,03	3	60	15	30	4	6132900203	6	6	100	26	60	6	6132900600
2,97	3	60	15	30	4	6132900297	6,01	6	100	26	60	6	6132900601
2,98	3	60	15	30	4	6132900298	6,02	6	100	26	60	6	6132900602
2,99	3	60	15	30	4	6132900299	6,03	6	100	26	60	6	6132900603
3	3	60	15	30	4	6132900300	7,97	8	118	36	75	6	6132900797
3,01	3	60	15	30	4	6132900301	7,98	8	118	36	75	6	6132900798
3,02	3	60	15	30	4	6132900302	7,99	8	118	36	75	6	6132900799
3,03	3	60	15	30	4	6132900303	8	8	118	36	75	6	6132900800
3,04	3	60	15	30	4	6132900304	8,01	8	118	36	75	6	6132900801
3,05	3	60	15	30	4	6132900305	8,02	8	118	36	75	6	6132900802
3,96	6	80	18	40	4	6132900396	8,03	8	118	36	75	6	6132900803
3,97	6	80	18	40	4	6132900397	9,97	10	135	36	90	6	6132900997
3,98	6	80	18	40	4	6132900398	9,98	10	135	36	90	6	6132900998
3,99	6	80	18	40	4	6132900399	9,99	10	135	36	90	6	6132900999
4	6	80	18	40	4	6132900400	10	10	135	36	90	6	6132901000
4,01	6	80	18	40	4	6132900401	10,01	10	135	36	90	6	6132901001
4,02	6	80	18	40	4	6132900402	10,02	10	135	36	90	6	6132901002
4,03	6	80	18	40	4	6132900403	10,03	10	135	36	90	6	6132901003
4,04	6	80	18	40	4	6132900404	11,97	12	150	45	100	6	6132901197
4,05	6	80	18	40	4	6132900405	11,98	12	150	45	100	6	6132901198
4,97	6	100	26	60	6	6132900497	11,99	12	150	45	100	6	6132901199
4,98	6	100	26	60	6	6132900498	12	12	150	45	100	6	6132901200
4,99	6	100	26	60	6	6132900499	12,01	12	150	45	100	6	6132901201
5	6	100	26	60	6	6132900500	12,02	12	150	45	100	6	6132901202
5,01	6	100	26	60	6	6132900501	12,03	12	150	45	100	6	6132901203

613 110

Lange Maschinenreibahlen aus VHM Carbide Reamers Long Series



- 10° Linksspirale, rechtsschneidend
- Lange Version für Zugangsprobleme
- Ab Ø14 mit Hartmetallkopf
- 1/100 Abmessungen Tol. +0,005
- Oberfläche blank
- 10° LH-helix, right hand cutting
- Long series for difficult access reaming
- Above Ø14 with carbide head
- 1/100 dimensions Tol. +0,005
- Bright finish

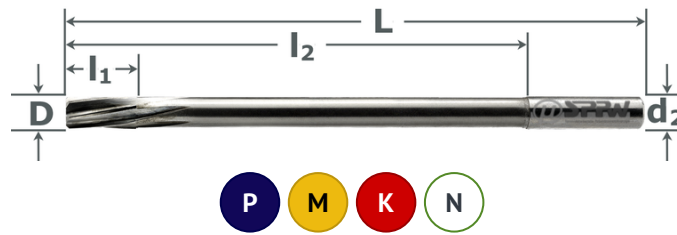

VHM	blank
Form B	H7 1/100
ZYL	L lang

ØD H7	Ød2 h6	L	l2	l1	z	Art. No.
1	1	50	30	12	4	6131100100
1,5	1,5	55	35	12	6	6131100150
2	2	65	45	14	6	6131100200
2,5	2,5	65	45	14	6	6131100250
3	3	90	70	14	6	6131100300
3,5	3,5	90	70	14	6	6131100350
3,98-3,99	4	105	80	16	6	613110xxxx
4	4	105	80	16	6	6131100400
4,01-4,02	4	105	80	16	6	613110xxxx
4,5	4,5	105	80	16	6	6131100450
4,98-4,99	5	115	90	16	6	613110xxxx
5	5	115	90	16	6	6131100500
5,01-5,02	5	115	90	16	6	613110xxxx
5,5	5,5	115	90	16	6	6131100550
5,98-5,99	6	130	100	16	6	613110xxxx
6	6	130	100	16	6	6131100600
6,01-6,02	6	130	100	16	6	613110xxxx
6,5	6	130	100	16	6	6131100650
7	7	140	110	18	6	6131100700
7,5	7	140	110	18	6	6131100750
7,98-7,99	8	160	130	18	6	613110xxxx

ØD H7	Ød2 h6	L	l2	l1	z	Art. No.
8	8	160	130	18	6	6131100800
8,01-8,02	8	160	130	18	6	613110xxxx
8,5	8	160	130	18	6	6131100850
9	9	175	140	18	6	6131100900
9,5	9	175	140	18	6	6131100950
9,98-9,99	10	190	150	20	6	613110xxxx
10	10	190	150	20	6	6131101000
10,01-10,02	10	190	150	20	6	613110xxxx
10,5	10	190	150	20	6	6131101050
11	10	190	150	20	6	6131101100
11,5	12	220	170	22	6	6131101150
11,98-11,99	12	220	170	22	6	613110xxxx
12	12	220	170	22	6	6131101200
12,01-12,02	12	220	170	22	6	613110xxxx
13	12	220	170	22	8	6131101300
14	12	220	170	22	8	6131101400
15	12	220	170	22	8	6131101500
16	16	230	180	25	8	6131101600
18	16	230	180	25	8	6131101800
20	16	230	180	25	8	6131102000

613 120

Maschinenreibahlen VHM XXL - L=650 Carbide Reamers Extra Long Series



- 10° Linksspirale, rechtsschneidend
- Extra-lange Ausführung L:650
- Mit Hartmetallkopf
- Oberfläche blank
- 10° LH-helix, right hand cutting
- Super long series - OAL:650
- With carbide head
- Bright finish

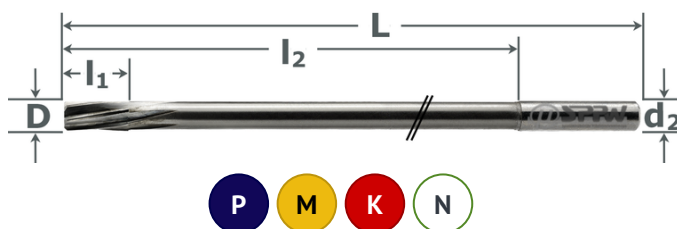

VHM	blank
Form B	H7
ZYL 3-FL	XXL

ØD H7	Ød2 h8	L	l2	l1	z	Art. No.
10	10	650	600	35	6	6131201000
12	10	650	600	40	6	6131201200
14	12	650	600	45	8	6131201400

ØD H7	Ød2 h8	L	l2	l1	z	Art. No.
16	12	650	600	50	8	6131201600
18	16	650	600	55	8	6131201800
20	16	650	600	60	8	6131202000

613 280

HP-Sackloch-Maschinenreibahlen VHM+X.Cut mit IK 1/100 Carbide HP Blind Hole Reamers+X.Cut Internal Cooling 1/100



- Reiben von Grundlöchern
- Geradegenutet, rechtsschneidend
- Kühlmittelaustritt an der Spitze
- Oberfläche X.Cut beschichtet
- △ SONDER: Lieferzeit ca. 15 Tage, keine Rücknahme. Staffelpreise (1-5)!

- Reaming of blind holes
- Straight flutes, right hand cutting
- Coolant exits through top
- With X.Cut coating
- △ SPECIAL: Delivery time approx. 15 working days. No returns. Scale prices!

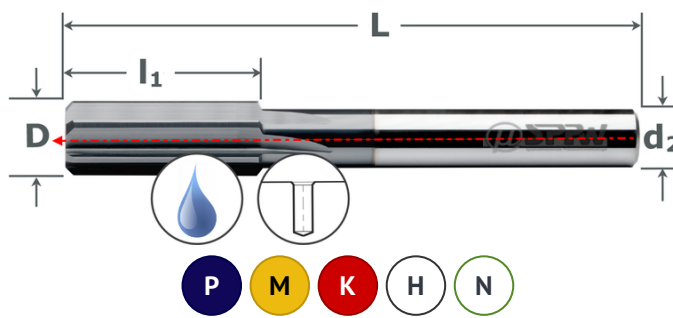

VHM	X Cut
Form A	1/100 H7
z: 6-8	IK cool

ØD +0,004	Ød2 h6	L	l1	z	Art. No.
5,98-6,55	6	60	20	6	613280xxxx
6 H7	6	60	20	6	6132800600H7
6,56-7,05	6	60	20	6	613280xxxx
7,06-7,55	6	60	20	6	613280xxxx
7,56-8,05	6	60	20	6	613280xxxx
8 H7	6	60	20	6	6132800800H7
8,06-8,55	8	75	25	6	613280xxxx
8,56-9,05	8	75	25	6	613280xxxx
9,06-9,55	8	75	25	6	613280xxxx
9,56-10,05	8	75	25	6	613280xxxx

ØD +0,004	Ød2 h6	L	l1	z	Art. No.
10 H7	8	75	25	6	6132801000H7
10,06-10,55	10	75	25	6	613280xxxx
10,56-11,05	10	75	25	6	613280xxxx
11,06-11,55	10	75	25	6	613280xxxx
11,56-12,05	10	75	28	6	613280xxxx
12 H7	10	75	28	6	6132801200H7
12,06-13,05	12	75	28	6	613280xxxx
13,06-14,05	12	100	32	8	613280xxxx
14,06-15,05	12	100	32	8	613280xxxx
15,06-16,05	12	100	32	8	613280xxxx

E

613 281

Hochleistungs-Maschinenreibahlen VHM+X.Cut mit IK 1/100 Carbide HP Machine Reamers+X.Cut Internal Cooling 1/100



- Reiben von Durchgangsbohrungen
- Linksspirale, rechtsschneidend
- Innenkühlung durch die Spannuten
- Oberfläche X.Cut beschichtet
- △ SONDER: Lieferzeit ca. 15 Tage, keine Rücknahme. Staffelpreise!

- Reaming through holes
- Left hand helix, right hand cutting
- Internal cooling through flutes
- With X.Cut coating
- △ SPECIAL: Delivery time approx. 15 working days. No returns. Scale prices!

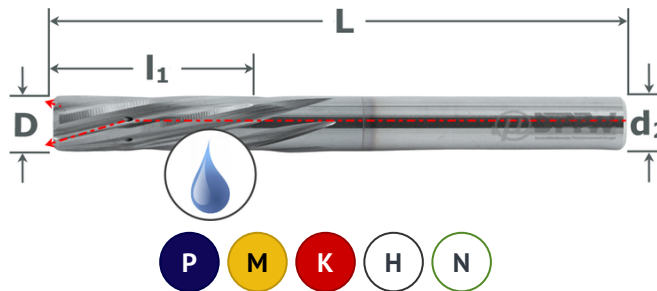

VHM	blank
Form B	1/100 H7
z: 6-8	IK cool

ØD +0,004	Ød2 h6	L	l1	z	l2	Art. No.
5,98-6,55	6	60	20	6		613281xxxx
6 H7	6	60	20	6		6132810600H7
6,56-7,05	6	60	20	6		613281xxxx
5,98-6,03	6	60	20	6		613281xxxx
7 H7	6	60	20	6		6132810700H7
7,06-7,55	6	60	20	6		613281xxxx
7,56-8,05	6	60	20	6		613281xxxx
8 H7	6	60	20	6		6132810800H7
8,06-9,05	8	75	25	6		613281xxxx
7,98-8,03	6	60	20	6		613281xxxx
9 H7	8	75	25	6		6132810900H7
9,06-9,55	8	75	25	6		613281xxxx

ØD +0,004	Ød2 h6	L	l1	z	l2	Art. No.
9,56-10,05	8	75	25	6		613281xxxx
10 H7	8	75	25	6		6132811000H7
10,06-10,55	10	75	25	6		613281xxxx
10,56-11,05	10	75	25	6		613281xxxx
11,06-11,55	10	75	25	6		613281xxxx
11,56-12,05	10	75	28	6		613281xxxx
12 H7	10	75	28	6		6132811200H7
12,06-13,05	12	75	28	6		613281xxxx
13,06-14,05	12	100	32	8		613281xxxx
14,06-15,05	12	100	32	8		613281xxxx
15,06-16,05	12	100	32	8		613281xxxx

613 667

Hochleistungs-Maschinenreibahlen VHM+X.Cut mit IK
Carbide HP Through Hole Reamers+X.Cut with Internal Cooling



- Durchgangsbohrungen Toleranz H7
- Linksspirale, rechtsschneidend
- Oberfläche X.Cut beschichtet
- Lieferzeit ca. 5 Arbeitstage

- Reaming of through holes
- Tolerance H7
- LH-helix, right hand cutting
- With X.Cut coating
- Delivery time 5 working days

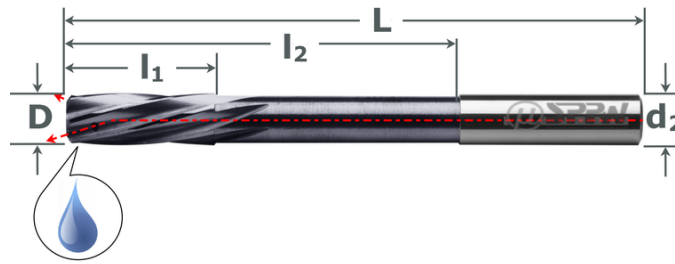

VHM	X Cut
DIN 212	Form B
H7	IK cool



E

ØD H7	Ød2 h6	L	l1	l2	z	Art. No.	ØD H7	Ød2 h6	L	l1	l2	z	Art. No.
3,9	4	75	19	51	6	6136670390	7,6-7,9	8	117	33	86	6	613667xxxx
4 H7	4	75	19	51	6	6136670400	8 H7	8	117	33	86	6	6136670800
4,1-4,2	4	75	19	51	6	613667xxxx	8,1-8,5	8	117	33	86	6	613667xxxx
4,3-4,7	4	75	19	51	6	613667xxxx	8,6-8,9	8	117	33	86	6	613667xxxx
4,8-4,9	5	86	23	60	6	613667xxxx	9 H7	8	117	33	86	6	6136670900
5 H7	5	86	23	60	6	6136670500	9,1-9,5	8	117	33	86	6	613667xxxx
5,1-5,3	5	86	23	60	6	613667xxxx	9,6-9,9	10	133	38	99	6	613667xxxx
5,4-5,8	5	86	23	60	6	613667xxxx	10 H7	10	133	38	99	6	6136671000
5,9	6	101	28	73	6	613667xxxx	10,1-10,9	10	133	38	99	6	613667xxxx
6 H7	6	101	28	73	6	6136670600	11 H7	10	133	38	99	6	6136671100
6,1-6,7	6	101	28	73	6	613667xxxx	11,1-11,3	10	133	38	99	6	613667xxxx
6,8-6,9	6	101	28	73	6	613667xxxx	11,4-11,9	12	151	44	106	6	613667xxxx
7 H7	6	101	28	73	6	6136670700	12 H7	12	151	44	106	6	6136671200
7,1-7,5	6	101	28	73	6	613667xxxx							

613 677

HP-Sackloch-Maschinenreibahlen VHM+X.Cut mit IK
Carbide HP Blind Hole Reamers+X.Cut with Internal Cooling



- Reiben von Grundlochbohrungen
- Rechtsspirale, rechtsschneidend
- Innenkühlung durch die Spannuten
- NC-Schaft Toleranz h6
- Oberfläche X.Cut beschichtet

- Reaming blind (ground) holes
- Right hand helix, right hand cutting
- Internal cooling through center
- With X.Cut coating

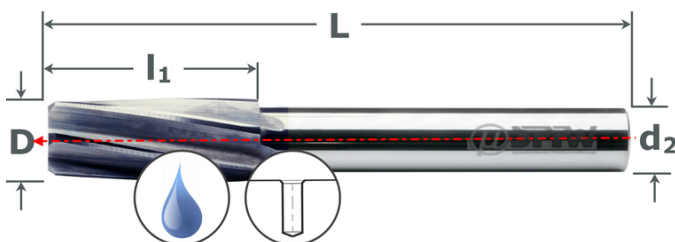

VHM	X Cut
Form D	H7
z:6	IK cool



ØD H7	Ød2 h6	L	l1	z	Art. No.	ØD H7	Ød2 h6	L	l1	z	Art. No.
4 H7	4	56	20	6	6136770400H7	8 H7	6,3	71	25	6	6136770800H7
5 H7	4	63	22	6	6136770500H7	10 H7	8	71	25	6	6136771000H7
6 H7	5	63	22	6	6136770600H7	12 H7	10	80	28	6	6136771200H7



- Anschnitt 45°, Durchgangsbohrungen
- Linkspirale, rechtsschneidend
- Oberfläche blank
- Toleranzen:
 $\varnothing \leq 3 +0,003$, $\varnothing \leq 6 +0,004$, $\varnothing > 6 +0,005$
 \triangle Abmessungen jetzt DIN 212. Wir liefern die alten Abmessungen so lange diese vorrätig sind.

- Chamfer 45°, through holes
- Left hand helix, right hand cutting
- Bright finish
- Tolerances:
 $\varnothing \leq 3 +0,003$, $\varnothing \leq 6 +0,004$, $\varnothing > 6 +0,005$
 \triangle Dimensions now DIN 212. We supply the old dimensions while stocks last.

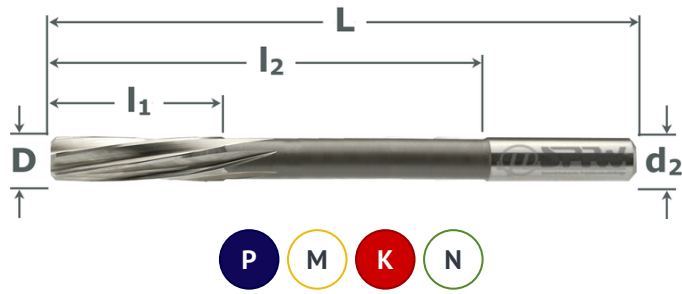

HSS E05	blank
DIN 212	Form B
1/100	z: 4-8
ZYL	

ØD	Ød2 h8	L	l1	l2	z	Art. No.
0,60-0,69	D	33	5	17	4	113270xxxx
0,70-0,79	D	33	5	17	4	113270xxxx
0,80-0,89	D	38	5	22	4	113270xxxx
0,90-1,05	D	38	5	22	4	113270xxxx
1,06-1,44	D	40	7	24	4	113270xxxx
1,45-1,50	D	40	7	24	4	113270xxxx
1,51-1,55 \triangle	D	43	9	24	4	113270xxxx
1,56-1,70	D	43	9	26	4	113270xxxx
1,71-1,79 \triangle	D	46	10	26	4	113270xxxx
1,80-1,90 \triangle	D	46	10	31	4	113270xxxx
1,91-1,95	D	49	11	31	4	113270xxxx
1,96-2,04	D	49	11	31	4	113270xxxx
2,05-2,12	D	49	11	31	4	113270xxxx
2,13-2,36 \triangle	D	53	12	31	4	113270xxxx
2,37-2,65	D	57	14	36	4	113270xxxx
2,66-2,95 \triangle	D	61	15	36	4	113270xxxx
2,96-3,00 \triangle	D	61	15	36	4	113270xxxx
3,01-3,04 \triangle	D	65	16	36	6	113270xxxx
3,05-3,35 \triangle	D	65	16	36	6	113270xxxx
3,36-3,75 \triangle	D	70	18	36	6	113270xxxx
3,76-3,95	4	75	19	47	6	113270xxxx
3,96-4,04	4	75	19	47	6	113270xxxx
4,05-4,25	4	75	19	47	6	113270xxxx
4,26-4,75 \triangle	4,5	80	21	52	6	113270xxxx
4,76-4,95	5	86	23	58	6	113270xxxx
4,96-5,04	5	86	23	58	6	113270xxxx
5,05-5,30	5	86	23	58	6	113270xxxx
5,31-5,80 \triangle	5,6	93	26	58	6	113270xxxx
5,81-5,95 \triangle	5,6	93	26	58	6	113270xxxx
5,96-6,00 \triangle	5,6	93	26	58	6	113270xxxx
6,01-6,04 \triangle	6,3	101	28	65	8	113270xxxx
6,05-6,70 \triangle	6,3	101	28	65	8	113270xxxx
6,71-6,95 \triangle	7,1	109	31	73	8	113270xxxx
6,96-7,04 \triangle	7,1	109	31	73	8	113270xxxx
7,05-7,50 \triangle	7,1	109	31	73	8	113270xxxx
7,51-7,55 \triangle	8	117	33	81	8	113270xxxx
7,56-7,95	8	117	33	81	8	113270xxxx
7,96-8,04	8	117	33	81	8	113270xxxx

ØD	Ød2 h8	L	l1	l2	z	Art. No.
8,05-8,50	8	117	33	81	8	113270xxxx
8,51-8,55 \triangle	9	125	36	85	8	113270xxxx
8,56-8,95	9	125	36	85	8	113270xxxx
8,96-9,04	9	125	36	85	8	113270xxxx
9,05-9,49	9	125	36	85	8	113270xxxx
9,50-9,55 \triangle	10	133	38	93	8	113270xxxx
9,56-9,95	10	133	38	93	8	113270xxxx
9,96-10,04	10	133	38	93	8	113270xxxx
10,05-10,60	10	133	38	93	8	113270xxxx
10,61-10,95 \triangle	10	142	41	102	8	113270xxxx
10,96-11,04 \triangle	10	142	41	102	8	113270xxxx
11,05-11,30 \triangle	10	142	41	102	8	113270xxxx
11,31-11,80 \triangle	10	142	41	102	8	113270xxxx
11,81-11,95 \triangle	10	151	44	111	8	113270xxxx
11,96-12,04 \triangle	10	151	44	111	8	113270xxxx
12,05-12,95 \triangle	10	151	44	111	8	113270xxxx
12,96-13,04	10	151	44	111	8	113270xxxx
13,05-13,20	10	151	44	111	8	113270xxxx
13,21-13,96 \triangle	12,5	162	50	115	8	113270xxxx
13,97-14,05 \triangle	12,5	162	50	117	8	113270xxxx
14,06-14,96 \triangle	12,5	162	50	117	8	113270xxxx
14,97-15,00 \triangle	12,5	162	50	117	8	113270xxxx
15,01-15,05 \triangle	12,5	170	52	125	8	113270xxxx
15,06-16,00 \triangle	12,5	170	52	125	8	113270xxxx
16,01-16,05 \triangle	14	175	54	130	8	113270xxxx
16,06-16,20 \triangle	14	175	54	130	8	113270xxxx
16,97-17,00	14	175	54	130	8	113270xxxx
17,01-17,05	14	182	56	137	8	113270xxxx
17,97-18,00	14	182	56	137	8	113270xxxx
18,01-18,05	16	189	58	141	8	113270xxxx
18,1	16	189	58	141	8	1132701810
18,2	16	189	58	141	8	1132701820
18,97-19,00	16	189	58	141	8	113270xxxx
19,01-19,05 \triangle	16	195	60	147	8	113270xxxx
19,97-20,05	16	195	60	147	8	113270xxxx
20,1	16	195	60	147	8	1132702010
20,2	16	195	60	147	8	1132702020





- Für Passungen nach Vorgabe
- Linkspirale, rechtsschneidend
- Oberfläche blank
- Lieferzeit ca. 5-8 Arbeitstage
- Sonderanfertigung, kein Umtausch
- Special Fit Reamers
- LH-helix, right hand cutting
- Bright finish
- Delivery time 5-8 working days
- Special production, no returns

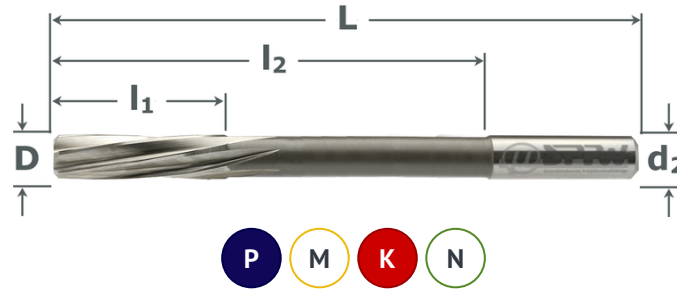

HSS E05	blank
DIN 212	Form B
SPX TOL	ZYL
1/100	

E

ØD	Ød2 h8	L	l1	l2	z	Art. No.	ØD	Ød2 h8	L	l1	l2	z	Art. No.
Ø3,76-4,25	4	75	19	43	6	1131810400	0,61-11,80	10	142	41	96	6	1131811100
Ø4,26-4,75	4,5	80	21	47	6	1131810450	1,81-13,20	12	151	44	105	6	1131811200
Ø4,76-5,30	5	86	23	52	6	1131810500	3,21-14,00	12	160	47	110	8	1131811400
Ø5,31-6,00	6	93	26	57	6	1131810550	4,01-15,00	12	162	50	112	8	1131811500
Ø6,01-6,70	6	101	28	63	6	1131810600	5,01-16,00	12	170	52	120	8	1131811600
Ø6,71-7,50	7	109	31	69	6	1131810700	6,01-17,00	14	175	54	123	8	1131811700
Ø7,51-8,50	8	117	33	75	6	1131810800	7,01-18,00	14	182	56	130	8	1131811800
Ø8,51-9,50	9	125	36	81	6	1131810900	8,01-19,00	16	189	58	131	8	1131811900
9,51-10,60	10	133	38	87	6	1131811000	9,01-20,00	16	195	60	137	8	1131812000

— INFO —

1/100-Reibahlen und Passungsreibahlen | Centesimal and Special Fit Reamers

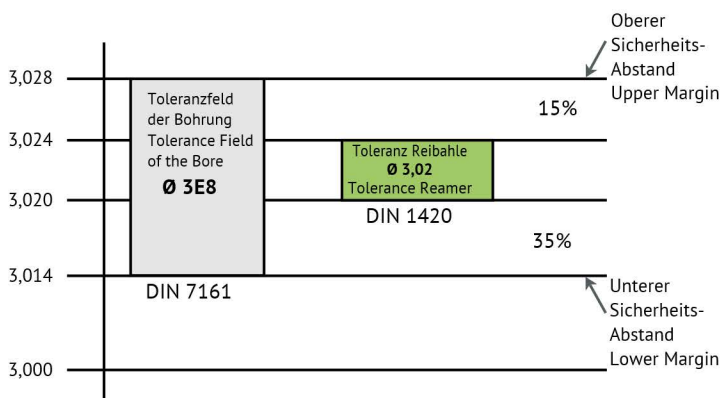

Viele Passungen sind im 1/100-Bereich möglich:

Beispiel: **Ø3 E8 = +25/+20**
 3,020 - 3,025 (Toleranzbereich der Passung)
 + 0/0,003 (+ Toleranzbereich der 1/100-Reibahlen)
 = **3,02** (1/100-Reibahle möglich!)

Centesimal reamers are suited for many special fits :

Example: **Ø3 E8 = +25/+20**
 3.020 - 3.025 (tolerance range of the fit)
 + 0/0.003 (+ tolerance range of 1/100 reamers)
 = **3.02** (1/100 reamer possible!)

113 199

Reibahlen HSS-E05 DIN 208 mit MK-Schaft 1/100

HSS-E05 Machine Reamers DIN 208 with Morse Taper Shank 1/100



- 1/100 und Passungen nach Vorgabe
- 10° Linksspirale, rechtsschneidend
- Oberfläche blank
- Toleranz 0/+0,004
- △ SONDER: Lieferzeit ca. 5-8 Tage, keine Rücknahme. Staffelpreise!

- Centesimal and Special fit reamers
- 10° LH-helix, right hand cutting
- Bright finish
- Tolerance 0/+0,004
- △ SPECIAL: Delivery time approx. 5-8 working days. No returns. Scale prices!

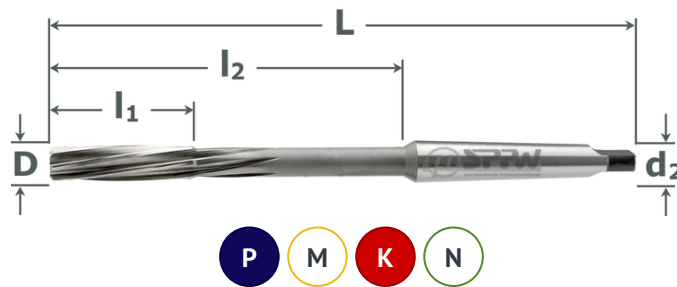

HSS E05	blank
DIN 208	Form B
SPX 1/100	MK MTS

ØD	L	l1	l2	z	MK Nr.	Art. No.
6,01-6,70	144	28	78	6	1	113199xxxx
6,71-7,00	150	31	84	6	1	113199xxxx
7,01-7,50	150	31	84	6	1	113199xxxx
7,51-8,00	156	33	90	6	1	113199xxxx
8,01-8,50	156	33	90	6	1	113199xxxx
8,51-9,00	162	36	96	6	1	113199xxxx
9,01-9,50	162	36	96	6	1	113199xxxx
9,51-10,00	168	38	102	6	1	113199xxxx
10,01-10,60	168	38	102	6	1	113199xxxx
10,61-11,80	175	41	109	6	1	113199xxxx
11,81-13,20	182	44	116	6	1	113199xxxx
13,21-14,00	189	47	123	8	1	113199xxxx
14,01-15,00	204	50	124	8	2	113199xxxx
15,01-16,00	210	52	130	8	2	113199xxxx
16,01-17,00	214	54	134	8	2	113199xxxx
17,01-18,00	219	56	139	8	2	113199xxxx
18,01-19,00	223	58	143	8	2	113199xxxx

ØD	L	l1	l2	z	MK Nr.	Art. No.
19,01-20,00	228	60	148	8	2	113199xxxx
20,01-21,20	232	62	152	8	2	113199xxxx
21,21-22,40	237	64	157	8	2	113199xxxx
22,41-23,00	241	66	161	8	2	113199xxxx
23,01-23,60	241	66	161	8	2	113199xxxx
23,61-25,00	268	68	169	10	3	113199xxxx
25,01-26,50	273	70	174	10	3	113199xxxx
26,51-28,00	277	71	178	10	3	113199xxxx
28,01-30,00	281	73	181	10	3	113199xxxx
30,01-31,50	285	75	187	10	3	113199xxxx
31,51-32,00	290	77	191	10	3	113199xxxx
32,01-35,10	321	78	197	10	4	113199xxxx
35,11-38,10	329	81	205	10	4	113199xxxx
38,11-40,10	329	81	205	12	4	113199xxxx
40,11-45,10	336	83	212	12	4	113199xxxx
45,11-50,10	344	86	220	12	4	113199xxxx

E



- Anschnitt 45°, Durchgangsbohrungen
 - Toleranz H7
 - 10° Linksspirale, rechtsschneidend
 - Oberfläche blank
- △ Abmessungen jetzt DIN 212. Wir liefern alte Abmessungen so lange diese vorrätig sind.

- Chamfer 45°, reaming through holes
 - Tolerance H7
 - 10° LH-helix, right hand cutting
 - Special tolerances of choice
 - Bright finish
- △ Dimensions now DIN 212. We supply the old dimensions while stocks last.

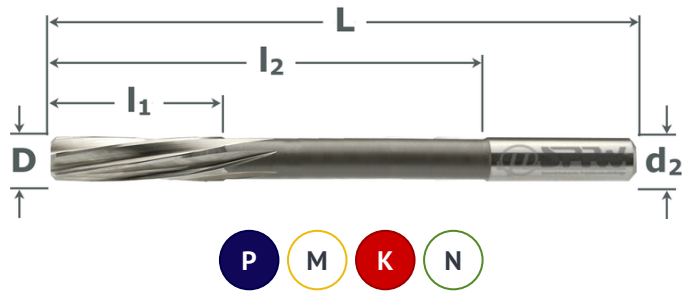

HSS E05	blank
DIN 212	Form B
H7	z: 4-8
ZYL	

E

ØD	Ød2 h8	L	l1	l2	Art. No.	ØD	Ød2 h8	L	l1	l2	Art. No.
1	D	38	5	22	1131800100	8,6-8,9	9	125	36	85	113180xxxx
1,1-1,4	D	40	7	24	113180xxxx	9	9	125	36	85	1131800900
1,5	D	40	7	24	1131800150	9,1-9,4	9	125	36	85	113180xxxx
1,6-1,7	D	43	9	24	113180xxxx	9,5△	10	133	38	93	113180xxxx
1,8-1,9△	D	46	10	31	113180xxxx	9,6-9,9	10	133	38	93	113180xxxx
2	D	49	11	31	1131800200	10	10	133	38	93	1131801000
2,1	D	49	11	31	1131800210	10,1-10,5	10	133	38	93	113180xxxx
2,2-2,3△	D	53	12	31	113180xxxx	10,7-10,9△	10	133	38	93	113180xxxx
2,4-2,6	D	57	14	36	113180xxxx	11,0△	10	142	41	102	113180xxxx
2,7-2,9△	D	61	15	36	113180xxxx	11,1-11,3△	10	142	41	102	113180xxxx
3,0△	D	61	15	36	113180xxxx	11,4-11,8△	10	142	41	102	113180xxxx
3,1-3,3△	D	65	166	36	113180xxxx	11,9△	10	151	44	111	113180xxxx
3,4-3,7△	D	70	18	36	113180xxxx	12,0△	10	151	44	111	113180xxxx
3,8-3,9	4	75	19	47	113180xxxx	12,5△	10	151	44	111	113180xxxx
4	4	75	19	47	1131800400	13,0△	10	151	44	111	113180xxxx
4,1-4,2	4	75	19	47	113180xxxx	13,5△	12,5	162	50	117	113180xxxx
4,3-4,7△	4,5	80	21	52	113180xxxx	14,0△	12,5	162	50	117	113180xxxx
4,8-4,9	5	86	23	58	113180xxxx	14,5△	12,5	162	50	117	113180xxxx
5	5	86	23	58	1131800500	15,0△	12,5	162	50	117	113180xxxx
5,1-5,3	5	86	23	58	113180xxxx	15,5△	12,5	170	52	125	113180xxxx
5,4-5,8△	5,6	93	26	58	113180xxxx	16,0△	12,5	170	52	125	113180xxxx
5,9△	5,6	93	28	58	113180xxxx	16,5△	14	175	54	130	113180xxxx
6,0△	5,6	93	28	58	113180xxxx	17,0△	14	175	54	130	113180xxxx
6,1-6,7△	6,3	101	28	65	113180xxxx	17,5△	14	182	56	137	113180xxxx
6,8-6,9△	7,1	109	31	73	113180xxxx	18,0△	14	182	56	137	113180xxxx
7,0△	7,1	109	31	73	113180xxxx	18,5	16	189	58	141	1131801850
7,1-7,5△	7,1	109	31	73	113180xxxx	19	16	189	58	141	1131801900
7,6-7,9	8	117	33	81	113180xxxx	19,5	16	195	60	147	1131801950
8	8	117	33	81	1131800800	20	16	195	60	147	1131802000
8,1-8,5	8	117	33	81	113180xxxx						



- Anschnitt 45°, Durchgangsbohrungen
- Toleranz H7
- 10° Linksspirale, rechtsschneidend
- Oberfläche X5.Cut beschichtet
△ Abmessungen jetzt DIN 212. Wir liefern alte Abmessungen so lange diese vorrätig sind.

- Chamfer 45°, reaming through holes
- Tolerance H7
- 10° LH-helix, right hand cutting
- With X5.Cut coating
△ Dimensions now DIN 212. We supply the old dimensions while stocks last.

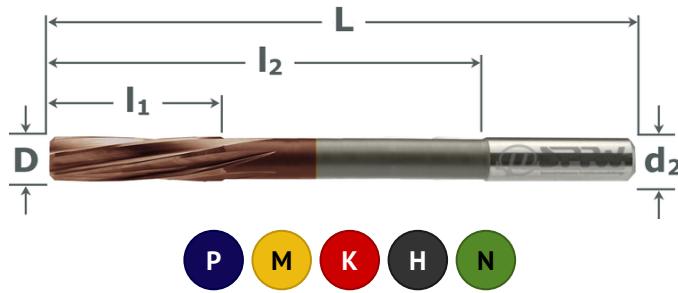

HSS E05	X Cut
DIN 212	Form B
H7	z: 4-8
ZYL	

ØD H7	Ød2 h8	L	l1	l2	Art. No.
1	D	38	5	22	1131870100
1,1-1,4	D	40	7	24	113187xxxx
1,5	D	40	7	24	1131870150
1,6-1,7	D	43	9	24	113187xxxx
1,8-1,9△	D	46	10	31	113187xxxx
2	D	49	11	31	1131870200
2,1	D	49	11	31	1131870210
2,2-2,3△	D	53	12	31	113187xxxx
2,4-2,6	D	57	14	36	113187xxxx
2,7-2,9△	D	61	15	36	113187xxxx
3,0△	D	61	15	36	113187xxxx
3,1-3,3△	D	65	166	36	113187xxxx
3,4-3,7△	D	70	18	36	113187xxxx
3,8-3,9	4	75	19	47	113187xxxx
4	4	75	19	47	1131870400
4,1-4,2	4	75	19	47	113187xxxx
4,3-4,7△	4,5	80	21	52	113187xxxx
4,8-4,9	5	86	23	58	113187xxxx
5	5	86	23	58	1131870500
5,1-5,3	5	86	23	58	113187xxxx
5,4-5,8△	5,6	93	26	58	113187xxxx
5,9△	5,6	93	28	58	113187xxxx

ØD H7	Ød2 h8	L	l1	l2	Art. No.
6,0△	5,6	93	28	58	113187xxxx
6,1-6,7△	6,3	101	28	65	113187xxxx
6,8-6,9△	7,1	109	31	73	113187xxxx
7,0△	7,1	109	31	73	113187xxxx
7,1-7,5△	7,1	109	31	73	113187xxxx
7,6-7,9	8	117	33	81	113187xxxx
8	8	117	33	81	1131870800
8,1-8,5	8	117	33	81	113187xxxx
8,6-8,9	9	125	36	85	113187xxxx
9	9	125	36	85	1131870900
9,1-9,4	9	125	36	85	113187xxxx
9,5△	10	133	38	93	113187xxxx
9,6-9,9	10	133	38	93	113187xxxx
10	10	133	38	93	1131871000
10,1-10,5	10	133	38	93	113187xxxx
10,7-10,9△	10	142	41	93	113187xxxx
11,0△	10	142	41	102	113187xxxx
11,1-11,3△	10	142	41	102	113187xxxx
11,4-11,8△	10	142	41	102	113187xxxx
11,9△	10	151	44	111	113187xxxx
12,0△	10	151	44	111	113187xxxx



113 190

Maschinenreibahlen HSS-E05 DIN 208 mit MK-Schaft H7

HSS-E05 Machine Reamers DIN 208 with Morse Taper Shank H7



- Anschnitt 45°, Durchgangsbohrungen
- Toleranz H7
- Linksspirale, rechtsschneidend
- Passungsmaße 5-8 Arbeitstage
- Oberfläche blank
- Chamfer 45°, reaming through holes
- Tolerance H7
- LH-helix, right hand cutting
- Special tolerances 5-8 working days
- Bright finish

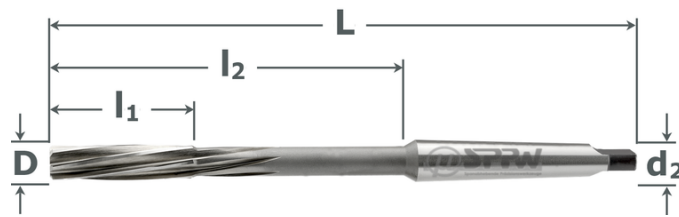

HSS E05	blank
DIN 208	Form B
H7	MK MTS

ØD H7	L	l1	l2	z	MK Nr.	Art. No.
10	168	38	102	6	1	1131901000
11	175	41	109	6	1	1131901100
12	182	44	116	6	1	1131901200
13	182	44	116	8	1	1131901300
14	189	47	123	8	1	1131901400
15	204	50	124	8	2	1131901500
16	210	52	130	8	2	1131901600
17	214	54	134	8	2	1131901700
18	219	56	139	8	2	1131901800
19	223	58	143	8	2	1131901900
20	228	60	148	8	2	1131902000
21	232	62	152	8	2	1131902100
22	237	64	157	8	2	1131902200
23	241	66	161	8	2	1131902300
24	268	68	168	10	3	1131902400
25	268	68	168	10	3	1131902500
26	273	70	173	10	3	1131902600
27	277	71	177	10	3	1131902700
28	277	71	177	10	3	1131902800
29	281	73	181	10	3	1131902900
30	281	73	181	10	3	1131903000
31	281	73	181	10	3	1131903100

ØD H7	L	l1	l2	z	MK Nr.	Art. No.
32	290	77	190	10	3	1131903200
33	321	78	197	10	4	1131903300
34	321	78	197	10	4	1131903400
35	321	78	197	10	4	1131903500
36	329	79	201	10	4	1131903600
37	329	79	201	10	4	1131903700
38	329	81	205	10	4	1131903800
39	329	81	205	12	4	1131903900
40	329	81	205	12	4	1131904000
41	336	83	212	12	4	1131904100
42	336	8	212	12	4	1131904200
43	336	83	212	12	4	1131904300
44	336	83	212	12	4	1131904400
45	336	83	212	12	4	1131904500
46	344	86	220	12	4	1131904600
47	344	86	220	12	4	1131904700
48	344	86	220	12	4	1131904800
49	344	86	220	12	4	1131904900
50	344	86	220	12	4	1131905000
55	344	86	220	12	4	1131905500
60	344	86	220	12	4	1131906000

E

513 110

Maschinenreibahlen HSS-E05 Lang H7 HSS-E05 Machine Reamers Long Series H7



- Anschnitt 45°, Toleranz H7
- Durchgangsbohrungen
- 10° Linksspirale, rechtsschneidend
- Lange Version, bei Zugangsproblemen
- Oberfläche blank

- Chamfer 45°, tolerance H7
- suited for through holes
- 10° LH-helix, right hand cutting
- Long series for difficult access reaming
- Bright finish

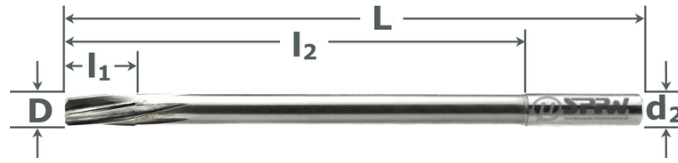

HSS E05	blank
Form B	H7
ZYL	L lang

ØD H7	Ød2 h8	L	l1	l2	z	Art. No.	ØD H7	Ød2 h8	L	l1	l2	z	Art. No.
1,5	1,5	55	12	35	6	5131100150	6,5	6	130	16	100	6	5131100650
2	2	65	14	45	6	5131100200	7	7	140	18	110	6	5131100700
2,5	2,5	75	14	55	6	5131100250	7,5	7	140	18	110	6	5131100750
3	3	90	14	70	6	5131100300	8	8	160	18	130	6	5131100800
3,5	3,5	90	14	70	6	5131100350	8,5	8	160	18	130	6	5131100850
4	4	105	16	80	6	5131100400	9	9	175	18	140	6	5131100900
4,5	4,5	105	16	80	6	5131100450	9,5	9	175	18	140	6	5131100950
5	5	115	16	90	6	5131100500	10	10	190	20	150	6	5131101000
5,5	5,5	115	16	90	6	5131100550	11	11	200	20	160	6	5131101100
6	6	130	16	100	6	5131100600	12	12	210	20	160	6	5131101200

513 120

Maschinenreibahlen HSS-E05 Überlang H7 HSS-E05 Machine Reamers Extra Long Series H7



- Anschnitt 45°, Toleranz H7
- Durchgangsbohrungen
- 10° Linksspirale, rechtsschneidend
- Überlange, bei Zugangsproblemen
- Oberfläche blank

- Chamfer 45°, tolerance H7
- Suited for through holes
- 10°LH-helix, right hand cutting
- Extra long series for difficult access
- Bright finish

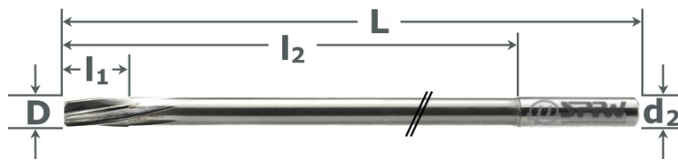

HSS E05	blank
Form B	H7
ZYL	XL

ØD H7	Ød2 h8	L	l1	l2	z	Art. No.	ØD H7	Ød2 h8	L	l1	l2	z	Art. No.
1,5	1,5	65	15	45	6	5131200150	5	5	200	30	175	6	5131200500
2	2	80	20	60	6	5131200200	5,5	5,5	220	30	195	6	5131200550
2,5	2,5	100	25	80	6	5131200250	6	6	250	35	220	6	5131200600
3	3	120	30	100	6	5131200300	7	7	250	35	220	6	5131200700
3,5	3,5	140	30	120	6	5131200350	8	8	250	35	220	6	5131200800
4	4	160	30	135	6	5131200400	9	9	250	35	220	6	5131200900
4,5	4,5	180	30	155	6	5131200450	10	10	250	35	220	6	5131201000

514 110

Maschinenreibahlen HSS-E05 mit MK-Schaft Lang H7

HSS-E05 Machine Reamers with Morse Taper Shank Long Series H7



- Anschnitt 45°, Toleranz H7
- Reiben von Durchgangsbohrungen
- 10° Linksspirale, rechtsschneidend
- Lange Version, bei Zugangsproblemen
- Oberfläche blank

- Chamfer 45°, tolerance H7
- Suited for through holes
- 10° LH-helix, right hand cutting
- Long series for difficult access
- Bright finish

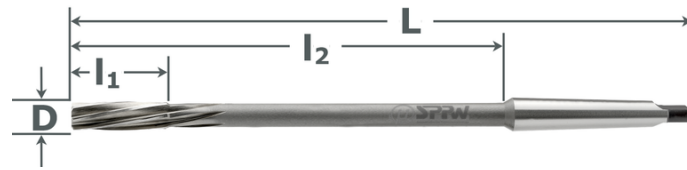

HSS E05	blank
Form B	H7
MK MTS	L lang

ØD H7	L	l1	l2	z	MK Nr.	Art. No.
12,5	245	22	180	8	1	5141101250
12,7	245	22	180	8	1	5141101270
13	245	22	180	8	1	5141101300
14	245	22	180	8	1	5141101400
15	260	22	180	8	2	5141101500
16	260	25	180	8	2	5141101600
18	260	25	180	8	2	5141101800
20	270	28	190	8	2	5141102000
22	280	28	200	8	2	5141102200
24	300	32	200	8	3	5141102400
25	320	32	220	8	3	5141102500

ØD H7	L	l1	l2	z	MK Nr.	Art. No.
26	330	32	230	10	3	5141102600
28	340	32	240	10	3	5141102800
30	350	36	250	10	3	5141103000
32	375	36	250	10	4	5141103200
34	375	36	250	10	4	5141103400
36	375	40	250	10	4	5141103600
38	395	40	270	10	4	5141103800
40	395	40	270	12	4	5141104000
42	405	40	280	12	4	5141104200
45	405	45	280	12	4	5141104500
50	415	45	290	12	4	5141105000

514 120

Maschinenreibahlen HSS-E05 MK-Schaft Überlang H7

HSS-E05 Machine Reamers Morse Taper Shank Extra Long Series H7



- Anschnitt 45°, Toleranz H7
- Durchgangsbohrungen
- 10° Linksspirale, rechtsschneidend
- Überlang, bei Zugangsproblemen
- Oberfläche blank

- Chamfer 45°, tolerance H7
- Suited for through holes
- 10° LH-helix, right hand cutting
- Extra long series for difficult access
- Bright finish

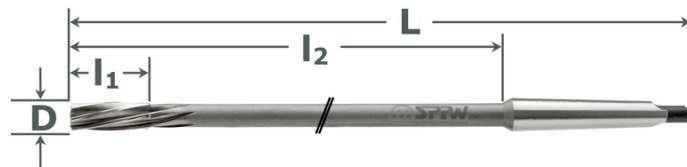

HSS E05	blank
Form B	H7
MK MTS	XL

ØD H7	L	l1	l2	z	MK Nr.	Art. No.
12	315	40	250	6	1	5141201200
14	315	40	250	8	1	5141201400
16	350	45	270	8	2	5141201600
18	350	45	270	8	2	5141201800
20	350	45	270	8	2	5141202000
22	350	45	270	8	2	5141202200
24	450	70	350	8	3	5141202400

ØD H7	L	l1	l2	z	MK Nr.	Art. No.
25	450	70	350	8	3	5141202500
26	450	70	350	10	3	5141202600
28	450	70	350	10	3	5141202800
30	450	70	350	10	3	5141203000
35	475	70	350	10	4	5141203500
40	475	70	350	12	4	5141204000

113 160

Maschinenreibahlen HSS-E05 DIN 212 A H7 HSS-E05 Machine Reamers DIN 212 A H7



- Anschnitt 45°, Grundbohrungen
- Toleranz H7
- Geradegenutet, rechtsschneidend
- Passungsmaße 5-8 Arbeitstagen
- Oberfläche blank
- Chamfer 45°, reaming of blind holes
- Tolerance H7
- Straight flutes, right hand cutting
- Special tolerances 5-8 working days
- Bright finish

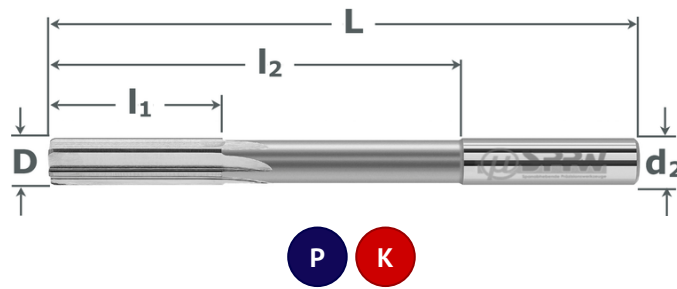

HSS E05	blank
DIN 212	Form A
H7	ZYL

ØD H7	Ød2 h8	L	l1	l2	z	Art. No.
1,5	1,5	40	8	26	4	1131600150
2	2	49	11	24	6	1131600200
2,5	2,5	57	15	29	6	1131600250
3	3	61	15	42	6	1131600300
4	4	75	19	51	6	1131600400
5	5	86	23	60	6	1131600500
6	6	93	26	73	6	1131600600
7	7	109	31	80	6	1131600700
8	8	117	33	86	6	1131600800
9	9	125	36	91	6	1131600900

ØD H7	Ød2 h8	L	l1	l2	z	Art. No.
10	10	133	38	99	6	1131601000
11	10	142	41	99	6	1131601100
12	12	151	44	106	6	1131601200
13	12	151	44	106	8	1131601300
14	12	160	47	110	8	1131601400
15	12	162	50	112	8	1131601500
16	12	170	52	117	8	1131601600
17	14	175	54	122	8	1131601700
18	14	182	56	129	8	1131601800
20	16	195	60	142	8	1131602000

113 200

Maschinenreibahlen HSS-E05 DIN 208 A mit MK-Schaft H7 HSS-E05 Machine Reamers DIN 208 A with Morse Taper Shank H7



- Anschnitt 45°, Grundbohrungen
- Geradegenutet, rechtsschneidend
- Toleranz H7
- Passungsmaße 5-8 Arbeitstagen
- Oberfläche blank
- Chamfer 45°, reaming of blind holes
- Straight flutes, right hand cutting
- Tolerance H7
- Special tolerances 5-8 working days
- Bright finish

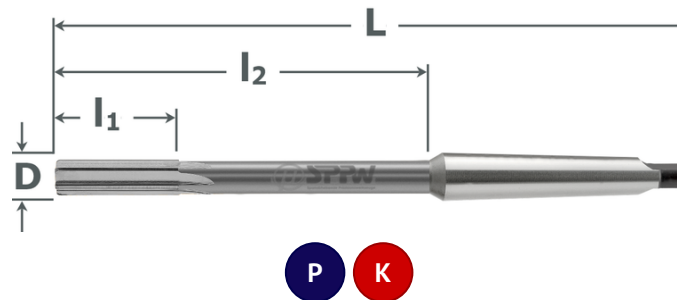

HSS E05	blank
DIN 208	Form A
H7	MK MTS

ØD H7	L	l1	l2	z	MK Nr.	Art. No.
6	138	28	72	6	1	1132000600
8	156	33	90	6	1	1132000800
10	168	38	102	6	1	1132001000
12	182	44	116	6	1	1132001200
13	182	44	116	8	1	1132001300
14	189	47	123	8	1	1132001400
15	204	50	124	8	2	1132001500
16	210	52	130	8	2	1132001600
17	214	54	134	8	2	1132001700
18	219	56	139	8	2	1132001800

ØD H7	L	l1	l2	z	MK Nr.	Art. No.
19	223	58	143	8	2	1132001900
20	228	60	148	8	2	1132002000
21	232	62	152	8	2	1132002100
22	237	64	157	8	2	1132002200
24	268	68	168	8	3	1132002400
25	268	68	168	8	3	1132002500
26	273	70	173	10	3	1132002600
28	277	71	177	10	3	1132002800
30	281	73	181	10	3	1132003000

113 170

Maschinen-Schälreibahnen HSS-E05 DIN 212 C H7 HSS-E05 Machine Reamers DIN 212 C H7



- Schälreibahle mit Zylinderschaft
- Toleranz H7
- Reiben von Durchgangsbohrungen
- Linksspirale, rechtsschneidend
- Passungsmaße 5-8 Arbeitstage
- Oberfläche blank
- Machine reamer with cylindrical shank
- Tolerance H7
- Reaming through holes
- LH-helix, right hand cutting
- Special tolerances 5-8 working days
- Bright finish

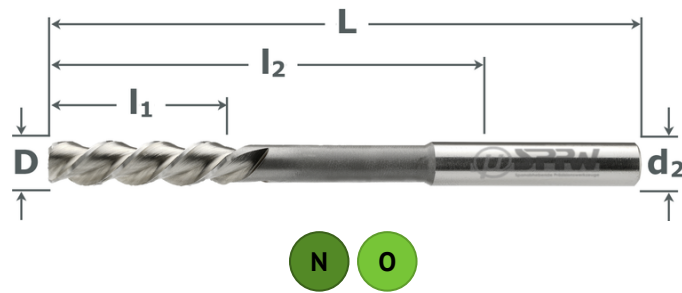

HSS E05	blank
DIN 212	Form C
H7	ZYL

ØD H7	Ød2 h8	L	l1	l2	z	Art. No.
1,5	1,5	40	8	26	3	1131700150
2	2	49	11	31	3	1131700200
2,5	2,5	57	15	38	3	1131700250
3	3	61	15	42	3	1131700300
3,5	3,5	70	18	46	3	1131700350
4	4	75	19	51	3	1131700400
4,5	4,5	80	21	55	3	1131700450
5	5	86	23	60	3	1131700500
5,5	5,5	93	26	66	3	1131700550
6	6	93	26	73	3	1131700600

ØD H7	Ød2 h8	L	l1	l2	z	Art. No.
7	7	109	31	80	3	1131700700
8	8	117	33	86	3	1131700800
9	9	125	36	91	3	1131700900
10	10	133	38	99	3	1131701000
11	10	142	41	99	4	1131701100
12	12	151	44	106	4	1131701200
13	12	151	44	106	4	1131701300
14	12	160	47	110	4	1131701400
15	12	162	50	112	4	1131701500

113 210

Maschinen-Schälreibahnen HSS-E05 DIN 208 C MK-Schaft H7 HSS-E05 Machine Reamers DIN 208 C with Morse Taper Shank H7



- Schälreibahle mit MK-Schaft
- Linksspirale, rechtsschneidend
- Toleranz H7
- Reiben von Durchgangsbohrungen
- Passungsmaße 5-8 Arbeitstagen
- Oberfläche blank
- Reamer with morse taper shank
- LH-helix, right hand cutting
- Tolerance H7
- Reaming through holes
- Special tolerances 5-8 working days
- Bright finish

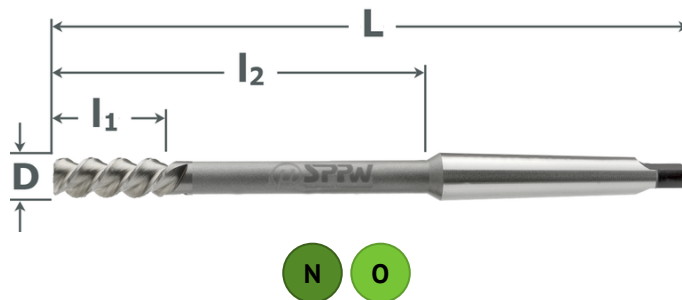

HSS E05	blank
DIN 208	Form C
H7	MK MTS

ØD H7	L	l1	l2	z	MK Nr.	Art. No.
6	138	28	72	3	1	1132100600
8	156	33	90	3	1	1132100800
10	168	38	102	3	1	1132101000
12	182	44	116	4	1	1132101200
14	189	47	123	4	1	1132101400
15	204	50	124	4	2	1132101500
16	210	52	130	6	2	1132101600
18	219	56	139	6	2	1132101800
20	228	60	148	6	2	1132102000
22	237	64	157	6	2	1132102200
24	268	68	168	6	3	1132102400

ØD H7	L	l1	l2	z	MK Nr.	Art. No.
25	268	68	168	6	3	1132102500
26	273	70	173	6	3	1132102600
27	277	71	177	6	3	1132102700
28	277	71	177	6	3	1132102800
29	281	73	181	6	3	1132102900
30	281	73	181	6	3	1132103000
32	290	77	190	8	3	1132103200
34	321	78	197	8	4	1132103400
35	321	78	197	8	4	1132103500
40	329	81	205	8	4	1132104000



- Reibahlen für Anspritzbohrungen
- Linksspirale, rechtsschneidend
- Form A mit Spanbrecher auf Anfrage
- Oberfläche blank
- Reamers for injection nozzles
- Left hand helix, right hand cutting
- Form A with chip breaker on request
- Bright finish

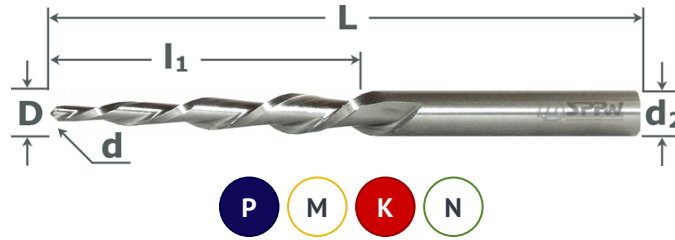

HSS E05	blank
Form C	z:5
ZYL	Konus 5%-10%

114740 - 5% (1:20)

ØD	Ød	Ød2 h8	L	l1	z	Art. No.
6	3	6	110	60	5	1147400600
8	4	8	130	80	5	1147400800
10	5	10	155	100	5	1147401000

ØD	Ød	Ød2 h8	L	l1	z	Art. No.
12	6	12	180	120	5	1147401200
14	7	14	200	140	5	1147401400

114750 - 8% (2:25)

ØD	Ød	Ød2 h8	L	l1	z	Art. No.
6	2	6	100	50	5	1147500600
8	3	8	110	62	5	1147500800
10	4	10	130	75	5	1147501000

ØD	Ød	Ød2 h8	L	l1	z	Art. No.
12	5	12	150	90	5	1147501200
14	6	14	160	100	5	1147501400

114760 - 10% (1:10)

ØD	Ød	Ød2 h8	L	l1	z	Art. No.
4	1,5	4	65	25	3	1147600400
6	2	6	90	40	5	1147600600
8	3	8	100	50	5	1147600800

ØD	Ød	Ød2 h8	L	l1	z	Art. No.
10	4	10	115	60	5	1147601000
12	5	12	130	70	5	1147601200
14	6	14	140	80	5	1147601400

— INFO —

Berechnung der Steigung konischer Reibahlen
Taper Calculation for Conical Reamers

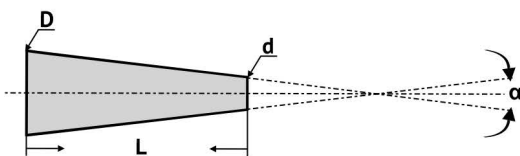

Steigung Taper in % = $\frac{D - d}{L} \cdot 100$

%	Konus Taper	α	%	Konus Taper	α	%	Konus Taper	α
1	1:100	0° 34'	10	1:10	5° 42'	25	1:4	14° 20'
2	1:50	1° 08'	10,5	-	6°	28	-	16°
3	3:100	1° 43'	11	-	6° 20'	30	-	17°
4	1:25	2° 16'	12	3:25	6° 50'	40	-	22° 40'
5	1:20	2° 51'	13	-	7° 25'	50	1:2	28° 05'
5,25	-	3°	14	-	8°	60	-	33° 25'
6	3:50	3° 25'	15	3:20	8° 35'	70	-	38° 35'
6,25	1:16	3° 34'	16	-	9° 10'	80	-	43° 40'
7	7:100	4°	18	-	10° 20'	90	-	48° 30'
8	2:25	4° 34'	20	1:5	11° 30'	100	1:1	53° 10'
9	9:100	5°	21	-	12°			

114 700

Kegel-Handreibahlen HSS Steigung 2% (1:50) HSS Taper Pin Hand Reamers 2% (1:50)



- Konisch 2% (1:50)
- Reiben konischer Bohrungen
- Linksspirale, rechtsschneidend
- Stiftloch-Handreibahle
- Oberfläche blank
- Tapered 2% (1:50)
- Reaming tapered holes
- LH-helix, right hand cutting
- Taper pin hand reamer
- Bright finish



HSS E05	blank
DIN 9	Form A
Hand	1:50 2%

ØD	ØD1	ØD2	Ød2 h9	L	l1	z	Art. No.	ØD	ØD1	ØD2	Ød2 h9	L	l1	z	Art. No.
0,6	0,5	0,9	1	38	20	2	1147000060	5	4,9	6,3	6,3	100	73	3	1147000500
0,8	0,7	1,2	1,2	42	24	2	1147000080	6	5,9	8	8	135	105	3	1147000600
1	0,9	1,4	1,5	46	28	2	1147000100	8	7,9	10,8	10	180	145	3	1147000800
1,2	1,1	1,7	1,8	50	32	2	1147000120	10	9,9	13,4	12,5	215	175	4	1147001000
1,5	1,4	2,1	2,2	57	37	3	1147000150	12	11,8	16	14	255	210	4	1147001200
2	1,9	2,8	3,1	72	48	3	1147000200	16	15,8	20,4	18	280	230	4	1147001600
2,5	2,4	3,3	3,3	72	48	3	1147000250	20	19,8	24,8	22,4	310	250	4	1147002000
3	2,9	4	4	80	58	3	1147000300	25	24,7	30,7	28	370	300	6	1147002500
4	3,9	5,2	5	93	68	3	1147000400	30	29,7	36,1	36,1	400	320	6	1147003000

114 780

Kegel-Maschinenreibahlen HSS für Morsekegel HSS Conical Machine Reamers for Morse Taper



- Schälreibahle für Morsekegel
- Kegelig oder stufig Reiben
- 45° Linksspirale, rechtsschneidend
- Nicht für zylindrische Bohrungen
- Oberfläche blank
- Reamer for morse taper shank
- Reaming tapered or stepped
- 45° LH-helix, right hand cutting
- Not for cylindrical holes
- Bright finish

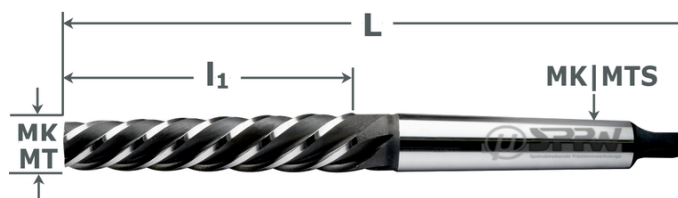

HSS	blank
Form C	MK MTS
for MTS	

for MK	L	l1	Schaft Nr	Art. No.	for MK	L	l1	Schaft Nr	Art. No.
#0	137	61	1	1147800000	#3	212	96	3	1147800300
#1	142	66	1	1147800100	#4	263	119	4	1147800400
#2	173	79	2	1147800200	#5	331	150	5	1147800500

114 785

Kegel-Handreibahlen HSS Steigung 6,25% (1:16)
HSS Conical Hand Reamers Form B 6,25% (1:16)



- Anschnitt 45°, konisch 1:16 (6,25%)
- Reiben konischer Bohrungen
- Linksspirale, rechtsschneidend
- Für Gewinde NPT, BSPT
- Oberfläche blank
- Chamfer 45°, tapered 1:16 (6,25%)
- Reaming tapered holes
- LH-helix, right hand cutting
- For threads NPT, BSPT
- Bright finish

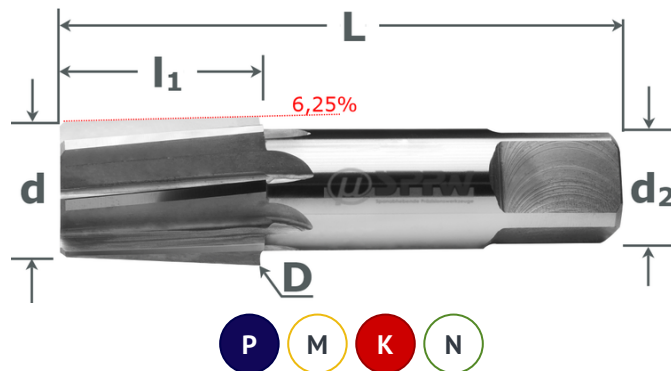

HSS	blank
Form B	Hand
1:16 6,25%	

NPT BSPT	Ød	ØD	Ød2 h9	L	l1	z	Art. No.
1/8"	7,9	9,21	8	59	21	4	1147850125
1/4"	10,7	12,1	10	67	22,5	5	1147850250
3/8"	14	15,62	12,5	75	26	5	1147850375
1/2"	17,2	19,32	16	87	34	6	1147850500

NPT BSPT	Ød	ØD	Ød2 h9	L	l1	z	Art. No.
3/4"	22,7	24,82	20	96	34	7	1147850750
1"	28,4	30,8	25	109	38,5	7	1147851000
1"1/4	37,2	39,82	31,5	119	42	9	1147851250
1"1/2	43,1	45,72	35,5	125	42	9	1147851500

E

613 150

Aviation Handreibahlen VHM H7
Aviation Carbide Hand Reamers H7



- Anschnitt 45°, Durchgangsbohrungen
- Toleranz H7
- 1/3 der Schneide 1:100 konisch
- Linksspirale, rechtsschneidend
- Oberfläche blank
- Chamfer 45°, reaming through holes
- Tolerance H7
- First part of flute tapered 1:100
- LH-helix, right hand cutting
- Bright finish

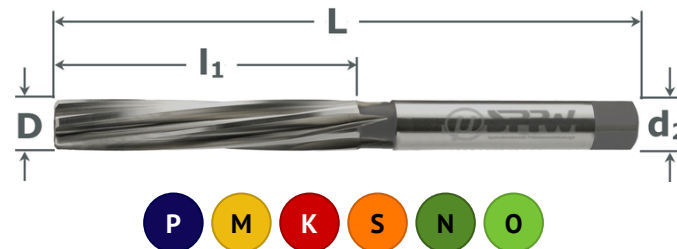

VHM	blank
Form B	H7
z:6	ZYL
Hand	

ØD H7	L	l1	Art. No.
3,98-3,99	100	60	613150xxxx
4	100	60	6131500400
4,01-4,02	100	60	613150xxxx
4,98-4,99	100	60	613150xxxx
5	100	60	6131500500
5,01-5,02	100	60	613150xxxx
5,98-5,99	100	60	613150xxxx
6	100	60	6131500600
6,01-6,02	100	60	613150xxxx

ØD H7	L	l1	Art. No.
7,98-7,99	100	60	613150xxxx
8	100	60	6131500800
8,01-8,02	100	60	613150xxxx
9,98-9,99	100	60	613150xxxx
10	100	60	6131501000
10,01-10,02	100	60	613150xxxx
11,98-11,99	100	60	613150xxxx
12	100	60	6131501200
12,01-12,02	100	60	613150xxxx



- Toleranz H7
- 1/3 der Schneide 1:100 steigend
- Reiben von Durchgangsbohrungen
- Linksspirale, rechtsschneidend
- Oberfläche blank
- First third of flute is tapered 1:100
- Tolerance H7
- Reaming through holes
- LH-helix, right hand cutting
- Bright finish

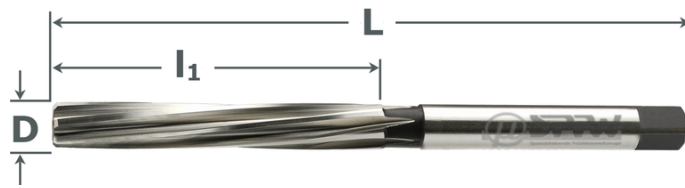

HSS	blank
DIN 206	Form B
H7	HAND



E

ØD H7	L	l1	z	Art. No.
1	34	13	3	1131500100
1,1-1,3	34	13	3	113150xxxx
1,4-1,5	41	20	3	113150xxxx
1,6-1,7	44	21	3	113150xxxx
1,8-1,9	47	23	4	113150xxxx
2	50	25	4	1131500200
2,1-2,3	52	26	4	113150xxxx
2,4-2,6	58	29	4	113150xxxx
2,7-2,9	58	29	6	113150xxxx
3	58	31	6	1131500300
3,1-3,3	66	33	6	113150xxxx
3,4-3,7	71	35	6	113150xxxx
3,8-3,9	76	38	6	113150xxxx
4	76	38	6	1131500400
4,1-4,2	76	38	6	113150xxxx
4,3-4,7	81	41	6	113150xxxx
4,8-4,9	87	44	6	113150xxxx
5	87	44	6	1131500500
5,1-5,3	87	44	6	113150xxxx
5,4-5,9	93	47	6	113150xxxx
6	93	47	6	1131500600
6,1-6,7	100	50	6	113150xxxx
6,8-6,9	107	54	6	113150xxxx
7	107	54	6	1131500700
7,1-7,5	107	54	6	113150xxxx
7,6-7,9	115	58	6	113150xxxx
8	115	58	6	1131500800
8,1-8,5	115	58	6	113150xxxx
8,6-8,9	124	62	6	113150xxxx
9	124	62	6	1131500900
9,1-9,5	124	62	6	113150xxxx
9,6-9,9	133	66	6	113150xxxx
10	133	66	6	1131501000
10,1-10,5	133	66	6	113150xxxx

ØD H7	L	l1	z	Art. No.
10,6-10,9	142	71	6	113150xxxx
11	142	71	6	1131501100
11,1-11,7	142	71	6	113150xxxx
11,8-11,9	152	76	6	113150xxxx
12	152	76	6	1131501200
12,5	152	76	6	1131501250
13	152	76	6	1131501300
13,5	163	81	8	1131501350
14	163	81	8	1131501400
14,5	163	81	8	1131501450
15	163	81	8	1131501500
15,5	175	87	8	1131501550
16	175	87	8	1131501600
16,5	175	87	8	1131501650
17	175	87	8	1131501700
17,5	188	93	8	1131501750
18	188	93	8	1131501800
18,5	188	93	8	1131501850
19	188	93	8	1131501900
19,5	201	100	8	1131501950
20	201	100	8	1131502000
21	215	107	8	1131502100
22	215	107	8	1131502200
23	215	107	8	1131502300
24	231	115	8	1131502400
25	231	115	8	1131502500
26	231	115	10	1131502600
27	247	124	10	1131502700
28	247	124	10	1131502800
29	247	124	10	1131502900
30	247	124	10	1131503000
31	265	133	10	1131503100
32	265	133	10	1131503200



Spanabhebende Präzisionswerkzeuge

[DE] **Senken**

[EN] **Sinking**



passion for precision

[Leidenschaft für Präzision]



HPC-Kegelsenker VHM

Carbide HPC Counter Sinks

Art.No./Page

● ● ● ● ●		VHM	X Cut	DIN 335C	90°	z:3	ZYL	60 HRC	654 607 Seite F 1
● ● ● ● ●		VHM	X Cut	~DIN 335C	90°	z:3	ZYL	L lang	654 304 Seite F 1
● ● ● ● ● ● ●		VHM	blank	DIN 335C	90°	z:3	ZYL	HPC	654 600 Seite F 2
● ● ● ● ● ● ●		VHM	blank	~DIN 335C	90°	z:3	ZYL	L lang	654 303 Seite F 2
● ● ● ● ●		VHM	X Cut	DIN 334C	60°	z:3	ZYL	60 HRC	654 657 Seite F 3
● ● ● ● ● ● ●		VHM	blank	DIN 334C	60°	z:3	ZYL	HPC	654 650 Seite F 3
● ● ● ● ●		VHM	X Cut	~DIN 335C	82°	z:3	ZYL	60 HRC	654 667 Seite F 4
○ ● ● ● ● ● ●		VHM	blank	~DIN 335C	82°	z:3	ZYL	HPC	654 660 Seite F 4
● ● ● ● ● ● ●		VHM	X Cut	~DIN 335C	100°	z:3	ZYL	60 HRC	654 917 Seite F 5
○ ● ● ● ● ● ●		VHM	blank	~DIN 335C	100°	z:3	ZYL	HPC	654 910 Seite F 5

Kegelsenker VHM

Carbide Counter Sinks

Art.No./Page

● ● ● ● ● ● ●		VHM	blank	~DIN 335C	90°	z:3	ZYL		652 300 Seite F 6
● ● ● ● ● ● ●		VHM	blank	~DIN 334C	60°	z:3	ZYL		653 300 Seite F 6

Kegelsenker HSS-E05/-E08 - 3 Schneiden

HSS-E05/-E08 Counter Sinks - 3 Flutes

Art.No./Page







● ● ● ● ●		HSS E05	blank	DIN 335C	90°	z:3	ZYL	Anti Vibe	155 600 Seite F 7
● ● ● ● ●		HSS E05	X Cut	DIN 335C	90°	z:3	ZYL	Anti Vibe	155 607 Seite F 8
● ● ● ● ●		HSS E05	X Cut	DIN 335C	90°	z:3	3 FLATS	Anti Vibe	155 608 Seite F 8
● ● ● ● ● ●		HSS E08	X Cut	DIN 335C	90°	z:3	ZYL		154 620 Seite F 9
● ● ● ● ● ●		HSS E08	blank	DIN 335C	90°	z:3	ZYL		154 610 Seite F 9

●	●	●	○	○							HSS E05	X Cut	DIN 335C	90°	z:3	ZYL	154 607 Seite F 10
●	●	●	○	○							HSS E05	X Cut	90°	z:3	ZYL	L lang	154 304 Seite F 10
●	●										HSS E05	A Cut	DIN 335C	90°	z:3	ZYL	154 700 Seite F 11
●	●	○		○							HSS E05	blank	90°	z:3	ZYL	L lang	154 303 Seite F 11
●	●	○		○							HSS E05	blank	DIN 335C	90° etc.	z:3	ZYL	154 600 Seite F 12
●	●	○		○							HSS E05	blank	30°	z:3	ZYL	154 630 Seite F 12	
●	●	○		○							HSS E05	blank	DIN 334	60°	z:3	ZYL	154 650 Seite F 12
●	●	○		○							HSS E05	blank	82°	z:3	ZYL	154 660 Seite F 13	
●	●	○		○							HSS E05	blank	100°	z:3	ZYL	154 910 Seite F 13	
●	●	○		○							HSS E05	blank	120°	z:3	ZYL	154 800 Seite F 13	

Querlochsenker HSS-E05

HSS-E05 Counter Sinks with Hole

Art.No./Page

				●	●						HSS E05	blank	90° etc.	QL hole	ZYL	153 000 Seite F 14
				●	●						HSS E05	blank	60°	ZYL	153 300 Seite F 14	
				●	●						HSS E05	blank	82°	ZYL	153 080 Seite F 14	
				●	●						HSS E05	blank	100°	ZYL	153 010 Seite F 14	
				●	●						HSS E05	blank	120°	ZYL	153 400 Seite F 14	
				●	●						HSS E05	A Cut	90°	ZYL	153 700 Seite F 15	

Kegelsenker HSS-E05 - 1 Schneide

HSS-E05 Counter Single Flute Sinks

Art.No./Page





○		●		○							HSS E05	blank	90° etc.	z:1	ZYL	153 900 Seite F 16
○		●		○							HSS E05	blank	30°	z:1	ZYL	154 030 Seite F 16

<input type="radio"/>	<input checked="" type="radio"/>	<input type="radio"/>	<input type="radio"/>	<input type="radio"/>	<input type="radio"/>		HSS E05	blank	45°	z:1	ZYL	154 045 Seite F 16
<input type="radio"/>	<input checked="" type="radio"/>	<input type="radio"/>	<input type="radio"/>	<input type="radio"/>	<input type="radio"/>		HSS E05	blank	60°	z:1	ZYL	153 950 Seite F 16
<input type="radio"/>	<input checked="" type="radio"/>	<input type="radio"/>	<input type="radio"/>	<input type="radio"/>	<input type="radio"/>		HSS E05	blank	82°	z:1	ZYL	153 980 Seite F 17
<input type="radio"/>	<input checked="" type="radio"/>	<input type="radio"/>	<input type="radio"/>	<input type="radio"/>	<input type="radio"/>		HSS E05	blank	120°	z:1	ZYL	154 100 Seite F 17

Zapfensenker HSS-E05 und VHM

Counter Sinks and Bores

Art.No./Page

<input checked="" type="radio"/>	<input checked="" type="radio"/>	<input checked="" type="radio"/>	<input type="radio"/>	<input type="radio"/>	<input type="radio"/>		VHM	blank	DIN 373	180°	z:3	ZYL	655 200 Seite F 18
<input checked="" type="radio"/>	<input checked="" type="radio"/>	<input type="radio"/>	<input type="radio"/>	<input type="radio"/>	<input type="radio"/>		HSS E05	A Cut	DIN 373	180°	z:3	ZYL	155 206 Seite F 18
<input checked="" type="radio"/>	<input checked="" type="radio"/>	<input type="radio"/>	<input type="radio"/>	<input type="radio"/>	<input type="radio"/>		HSS E05	blank	DIN 373	180°	z:3	ZYL	155 200 Seite F 19
<input checked="" type="radio"/>	<input checked="" type="radio"/>	<input type="radio"/>	<input type="radio"/>	<input type="radio"/>	<input type="radio"/>		HSS E05	A Cut	DIN 1866	90°	z:3	ZYL	155 806 Seite F 20
<input checked="" type="radio"/>	<input checked="" type="radio"/>	<input type="radio"/>	<input type="radio"/>	<input type="radio"/>	<input type="radio"/>		HSS E05	blank	DIN 1866	90°	z:3	ZYL	155 800 Seite F 20

654 607

Hochleistungs-Kegelsenker VHM+X.Cut 90°
Carbide High Performance Counter Sinks+X.Cut 90°



- Für den Einsatz auf CNC-Maschinen
- Monobloc, weniger Vibrationen
- Exzentrisch hinterschleifen
- Konstantes Profil
- Oberfläche X.Cut beschichtet
- Especially for CNC machines
- Monobloc carbide, less vibrations
- Excentric relief
- Constant profile
- With X.Cut coating

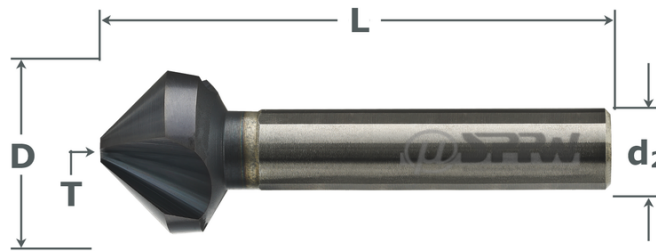

VHM	X Cut
DIN 335C	90°
z:3	ZYL
60 HRC	

ØD z9	Ød2 h9	ØT max.	L	z	Art. No.	ØD z9	Ød2 h9	ØT max.	L	z	Art. No.
4,3	4	1,3	40	3	6546070430	12,4	8	2,8	56	3	6546071240
5,3	4	1,5	40	3	6546070530	16,5	10	3,2	60	3	6546071650
6,3	5	1,5	45	3	6546070630	20,5	10	3,5	63	3	6546072050
8,3	6	2	50	3	6546070830	25	10	3,8	67	3	6546072500
10,4	6	2,5	50	3	6546071040	31	12	4,2	71	3	6546073100

654 304

Hochleistungs-Kegelsenker VHM+X.Cut 90° Lang
Carbide High Performance Counter Sinks+X.Cut 90° Long Series



- Lange Ausführung
- Verstärkter Zylinderschaft
- Monobloc, weniger Vibrationen
- Exzentrisch hinterschleifen
- Konstantes Profil
- Oberfläche X.Cut beschichtet
- Long series
- Reinforced cylindrical shank
- Monobloc carbide, less vibrations
- Excentric relief
- Constant profile
- With X.Cut coating



VHM	X Cut
~DIN 335C	90°
z:3	ZYL
L lang	

ØD z9	Ød2 h9	ØT max.	L	z	Art. No.	ØD z9	Ød2 h9	ØT max.	L	z	Art. No.
6,3	6	1,5	84	3	6543040630	12,4	10	2,8	108	3	6543041240
8,3	8	2	85	3	6543040830	16,5	12	3,2	112	3	6543041650
10,4	10	2,5	87	3	6543041040	20,5	12	3,5	115	3	6543042050

654 600

Hochleistungs-Kegelsenker VHM 90° Carbide High Performance Counter Sinks 90°



- Für den Einsatz auf CNC-Maschinen
- Monobloc, weniger Vibrationen
- Exzentrisch hinterschliffen
- Konstantes Profil
- Oberfläche blank

- Especially for CNC machines
- Monobloc carbide, less vibrations
- Excentric relief
- Constant profile
- Bright finish

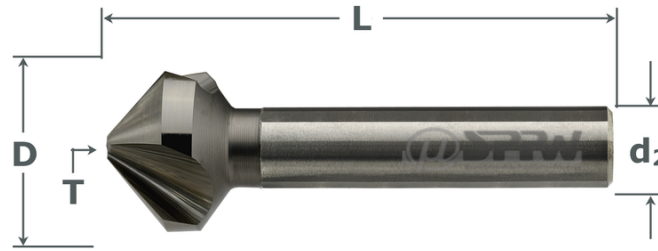

VHM	blank
DIN 335C	90°
z:3	ZYL
HPC	

ØD z9	Ød2 h9	ØT max.	L	z	Art. No.	ØD z9	Ød2 h9	ØT max.	L	z	Art. No.
4,3	4	1,3	40	3	6546000430	12,4	8	2,8	56	3	6546001240
5,3	4	1,5	40	3	6546000530	16,5	10	3,2	60	3	6546001650
6,3	5	1,5	45	3	6546000630	20,5	10	3,5	63	3	6546002050
8,3	6	2	50	3	6546000830	25	10	3,8	67	3	6546002500
10,4	6	2,5	50	3	6546001040	31	12	4,2	71	3	6546003100

654 303

Hochleistungs-Kegelsenker VHM 90° Lang Carbide High Performance Counter Sinks 90° Long Series



- Lange Ausführung
- Verstärkter Zylinderschaft
- Monobloc, weniger Vibrationen
- Exzentrisch hinterschliffen
- Konstantes Profil
- Oberfläche blank

- Long series
- Reinforced cylindrical shank
- Monobloc carbide, less vibrations
- Excentric relief
- Constant profile
- Bright finish



VHM	blank
~DIN 335C	90°
z:3	ZYL
L lang	

ØD z9	Ød2 h9	ØT max.	L	z	Art. No.	ØD z9	Ød2 h9	ØT max.	L	z	Art. No.
6,3	6	1,5	84	3	6543030630	12,4	10	2,8	108	3	6543031240
8,3	8	2	85	3	6543030830	16,5	12	3,2	112	3	6543031650
10,4	10	2,5	87	3	6543031040	20,5	12	3,5	115	3	6543032050

654 657

Hochleistungs-Kegelsenker VHM+X.Cut 60°
Carbide High Performance Counter Sinks+X.Cut 60°



- Harte und abrasive Werkstoffe
- Monobloc, weniger Vibrationen
- Exzentrisch hinterschleifen
- Konstantes Profil
- Oberfläche X.Cut beschichtet
- Hard and abrasive materials
- Monobloc carbide, less vibrations
- Excentric relief
- Constant profile
- With X.Cut coating

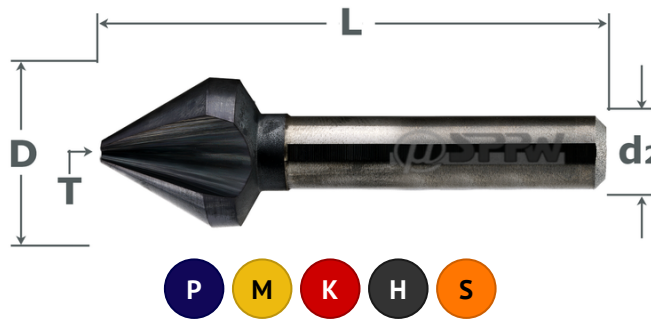

VHM	X Cut
DIN 334C	60°
z:3	ZYL
60 HRC	

ØD z9	Ød2 h9	ØT max.	L	z	Art. No.
6,3	5	1,5	47	3	6546570630
8,3	6	2	52	3	6546570830
10,4	6	2,5	53	3	6546571040
12,4	8	2,8	60	3	6546571240

ØD z9	Ød2 h9	ØT max.	L	z	Art. No.
16,5	10	3,2	65	3	6546571650
20,5	10	3,5	69	3	6546572050
25	10	3,8	75	3	6546572500
31	12	4,2	81	3	6546573100

654 650

Hochleistungs-Kegelsenker VHM 60°
Carbide High Performance Counter Sinks 60°



- Harte und abrasive Werkstoffe
- Monobloc, weniger Vibrationen
- Exzentrisch hinterschleifen
- Konstantes Profil
- Oberfläche blank
- Hard and abrasive materials
- Monobloc carbide, less vibrations
- Excentric relief
- Constant profile
- Bright finish

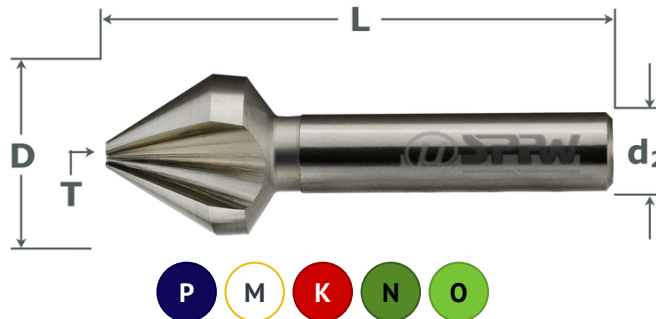

VHM	blank
DIN 334C	60°
z:3	ZYL
HPC	

ØD z9	Ød2 h9	ØT max.	L	z	Art. No.
6,3	5	1,5	47	3	6546500630
8,3	6	2	52	3	6546500830
10,4	6	2,5	53	3	6546501040
12,4	8	2,8	60	3	6546501240

ØD z9	Ød2 h9	ØT max.	L	z	Art. No.
16,5	10	3,2	65	3	6546501650
20,5	10	3,5	69	3	6546502050
25	10	3,8	75	3	6546502500
31	12	4,2	81	3	6546503100

654 667

Aviation Hochleistungs-Kegelsenker VHM+X.Cut 82°
Carbide High Performance Counter Sinks+X.Cut 82°



- Für den Einsatz im Flugzeugbau
- Monobloc, weniger Vibrationen
- Exzentrisch hinterschleifen
- Konstantes Profil
- Oberfläche X.Cut beschichtet
- Especially for aviation applications
- Monobloc carbide, less vibrations
- Excentric relief
- Constant profile
- With X.Cut coating

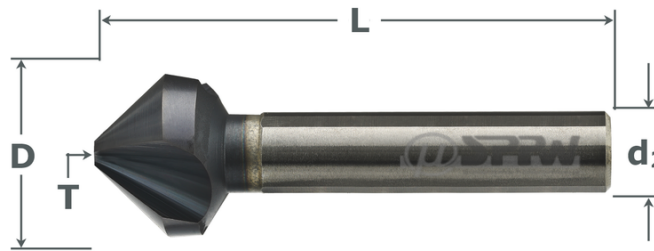

VHM	X Cut
~DIN 335C	82°
z:3	ZYL
60 HRC	

ØD z9	Ød2 h9	ØT max.	L	z	Art. No.	ØD z9	Ød2 h9	ØT max.	L	z	Art. No.
10,4	6	2,5	50	3	6546671040	20,5	10	3,5	64	3	6546672050
12,4	8	2,8	56	3	6546671240	25,0	10	3,8	68	3	6546672500
16,5	10	3,2	61	3	6546671650						

F

654 660

Aviation Hochleistungs-Kegelsenker VHM 82°
Carbide High Performance Counter Sinks 82°



- Für den Einsatz im Flugzeugbau
- Monobloc, weniger Vibrationen
- Exzentrisch hinterschleifen
- Konstantes Profil
- Oberfläche blank
- Especially for aviation applications
- Monobloc carbide, less vibrations
- Excentric relief
- Constant profile
- Bright finish

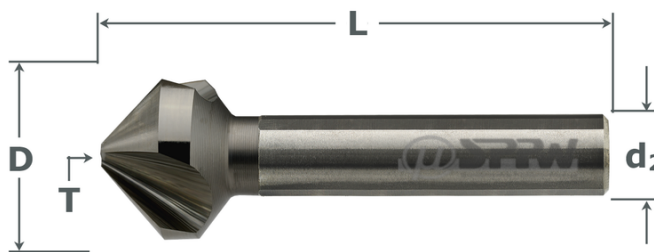

VHM	blank
~DIN 335C	82°
z:3	ZYL
HPC	

ØD z9	Ød2 h9	ØT max.	L	z	Art. No.	ØD z9	Ød2 h9	ØT max.	L	z	Art. No.
10,4	6	2,5	50	3	6546601040	20,5	10	3,5	64	3	6546602050
12,4	8	2,8	56	3	6546601240	25,0	10	3,8	68	3	6546602500
16,5	10	3,2	61	3	6546601650						

654 917

Aviation Hochleistungs-Kegelsenker VHM+X.Cut 100°
Carbide High Performance Counter Sinks+X.Cut 100°



- Speziell für den Flugzeugbau
- Monobloc, weniger Vibrationen
- Exzentrisch hinterschliffen
- Konstantes Profil
- Oberfläche X.Cut beschichtet
- Especially for aviation applications
- Monobloc carbide, less vibrations
- Excentric relief
- Constant profile
- With X.Cut coating

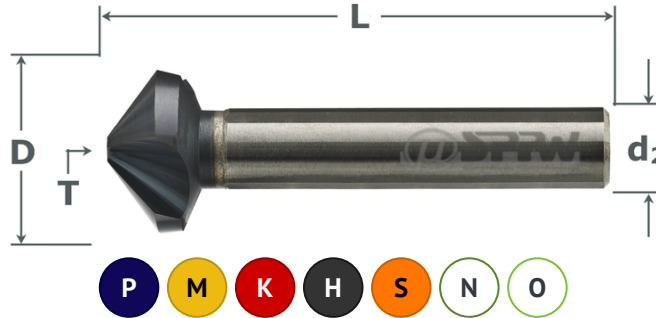

VHM	X Cut
~DIN 335C	100°
z:3	ZYL
60 HRC	

ØD z9	Ød2 h9	ØT max.	L	z	Art. No.	ØD z9	Ød2 h9	ØT max.	L	z	Art. No.
6,3	5	1,5	44	3	6549170630	12,4	8	2,8	55	3	6549171240
8,3	6	2	49	3	6549170830	16,5	10	3,2	59	3	6549171650
10,4	6	2,5	49	3	6549171040	20,5	10	3,5	62	3	6549172050

F

654 910

Aviation Hochleistungs-Kegelsenker VHM 100°
Carbide High Performance Counter Sinks 100°



- Für den Einsatz im Flugzeugbau
- Monobloc, weniger Vibrationen
- Exzentrisch hinterschliffen
- Konstantes Profil
- Oberfläche blank
- Especially for aviation applications
- Monobloc carbide, less vibrations
- Excentric relief
- Constant profile
- Bright finish



VHM	blank
~DIN 335C	100°
z:3	ZYL
HPC	

ØD z9	Ød2 h9	ØT max.	L	z	Art. No.	ØD z9	Ød2 h9	ØT max.	L	z	Art. No.
6,3	5	1,5	44	3	6549100630	12,4	8	2,8	55	3	6549101240
8,3	6	2	49	3	6549100830	16,5	10	3,2	59	3	6549101650
10,4	6	2,5	49	3	6549101040	20,5	10	3,5	62	3	6549102050

652 300

Kegelsenker VHM 3 Schneiden 90° Carbide Counter Sinks 3 Flutes 90°



- Ab Ø8,3 mit HM-Kopf, HSS Schaft
- 3 Schneiden und Zylinderschaft
- Senkwinkel 90°
- Oberfläche blank
- Ø8,3 and up with carbide head
- With 3 flutes and cylindrical shank
- Chamfering angle 90°
- Bright finish

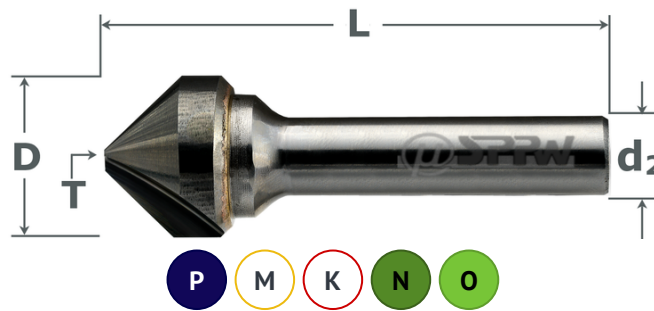

VHM	blank
~DIN 335C	90°
z:3	ZYL

ØD	Ød2 h9	L	z	Art. No.	ØD	Ød2 h9	L	z	Art. No.
4,3	6	50	3	6523000430	16,5	10	58	3	6523001650
6,3	6	51	3	6523000630	20,5	10	61	3	6523002050
8,3	6	52	3	6523000830	25,5	10	64	3	6523002500
10,4	6	53	3	6523001040	31,5	10	68	3	6523003100
12,4	8	55	3	6523001240					

653 300

Kegelsenker VHM 3 Schneiden 60° Carbide Counter Sinks 3 Flutes 60°



- Ab Ø8,3 mit HM-Kopf, HSS Schaft
- 3 Schneiden und Zylinderschaft
- Senkwinkel 60°
- Oberfläche blank
- Ø8,3 and up with carbide head
- With 3 flutes and cylindrical shank
- Chamfering angle 60°
- Bright finish

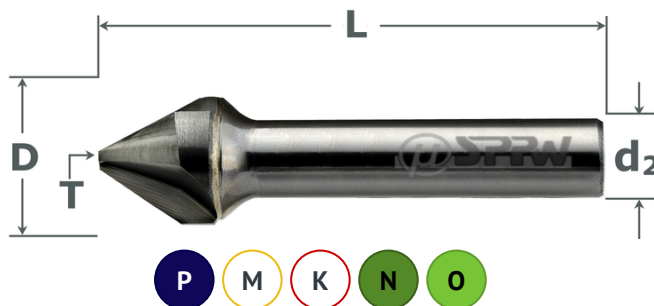

VHM	blank
~DIN 334C	60°
z:3	ZYL

ØD	Ød2 h9	L	z	Art. No.	ØD	Ød2 h9	L	z	Art. No.
4,3	6	50	3	6533000430	16,5	10	63	3	6533001650
6,3	6	51	3	6533000630	20,5	10	67	3	6533002050
8,3	6	55	3	6533000830	25,5	10	73	3	6533002500
10,4	6	56	3	6533001040	31,5	10	79	3	6533003100
12,4	8	59	3	6533001240					

155 600

Anti-Vibration Kegelsenker HSS-E05 90°
HSS-E05 Counter Sinks 90°



- Ungleichmäßige Schneidaufteilung
- Vibrationsfrei für bessere Oberflächen
- Exzentrischer Hinterschliff
- Konstantes Profil
- Hochpositiver Schnitt, hohe Laufruhe
- Senkwinkel 90°, Oberfläche blank
- Unequal division of flutes
- No vibrations, better surface quality
- Excentric relief, constant profile
- High positive cut, chatter free working
- Chamfering angle 90°, Bright finish

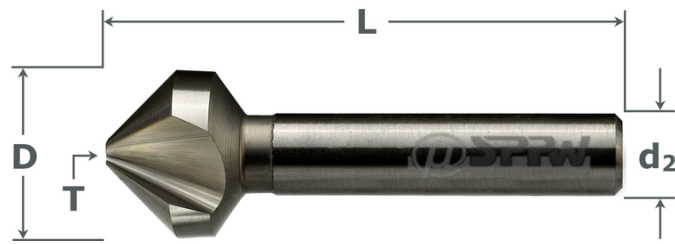

HSS E05	blank
DIN 335C	90°
z:3	ZYL
Anti Vibe	

ØD z9	Ød2 h9	L	z	T	Art. No.
4,3	4	40	3	1,3	1556000430
5,3	4	40	3	1,5	1556000530
6	5	45	3	1,5	1556000600
6,3	5	45	3	1,5	1556000630
8	6	50	3	2	1556000800
8,3	6	50	3	2	1556000830
9,4	6	50	3	2,2	1556000940
10	6	50	3	2,5	1556001000
10,4	6	50	3	2,5	1556001040
11,5	8	56	3	2,8	1556001150

ØD z9	Ød2 h9	L	z	T	Art. No.
12	8	56	3	2,8	1556001200
12,4	8	56	3	2,8	1556001240
15	10	60	3	3,2	1556001500
16,5	10	60	3	3,2	1556001650
20,5	10	63	3	3,5	1556002050
25	10	67	3	3,8	1556002500
28	12	71	3	4	1556002800
30	12	71	3	4,2	1556003000
31	12	71	3	4,2	1556003100



— INFO —

Kegelsenker mit ungleicher Teilung | Counter Sinks with Unequal Division

Spezielle ANTI VIBRATION Geometrie mit ungleicher Teilung
= beste Oberflächenqualität
Special ANTI VIBRATION geometry
= unmatched finish

HSS-E05 + X.Cut Beschichtung
3500 HV = bessere Performance
HSS-E05 + X.Cut Coating
3500 HV = better performance

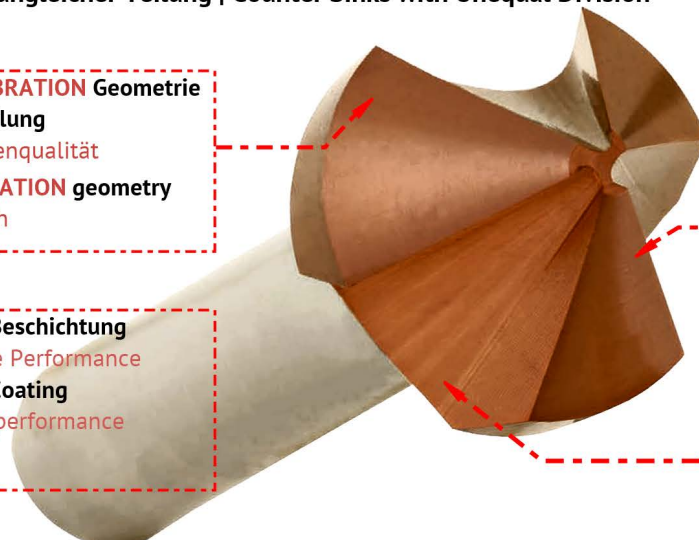

Konstant hinterschliffenes Profil
= mehrfaches Nachschleifen
Constant relief profile
= multiple regrinds

Weit geöffnete Spannuten
= bessere Spanabfuhr
Wide open grooves
= improved chip removal

155 607**Anti-Vibration Kegelsenker HSS-E05+X.Cut 90°
HSS-E05 Counter Sinks+X.Cut 90°**

- Ungleichmäßige Schneidaufteilung
- Vibrationsfrei für bessere Oberflächen
- Exzentrischer Hinterschliff
- Konstantes Profil
- Hochpositiver Schnitt, hohe Laufruhe
- Senkwinkel 90°
- Oberfläche X5.Cut beschichtet
- Unequal division of flutes
- No vibrations, better surface quality
- Excentric relief, constant profile
- High positive cut, chatter free working
- Chamfering angle 90°
- With X5.Cut coating

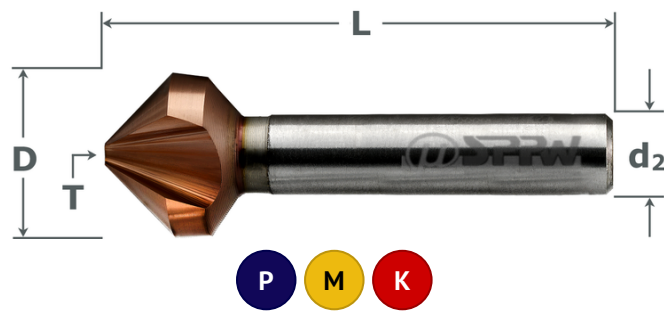

HSS E05	X Cut
DIN 335C	90°
z:3	ZYL
Anti Vibe	

ØD z9	Ød2 h9	L	z	T	Art. No.	ØD z9	Ød2 h9	L	z	T	Art. No.
4,3	4	40	3	1,3	1556070430	12	8	56	3	2,8	1556071200
5,3	4	40	3	1,5	1556070530	12,4	8	56	3	2,8	1556071240
6	5	45	3	1,5	1556070600	15	10	60	3	3,2	1556071500
6,3	5	45	3	1,5	1556070630	16,5	10	60	3	3,2	1556071650
8	6	50	3	2	1556070800	20,5	10	63	3	3,5	1556072050
8,3	6	50	3	2	1556070830	25	10	67	3	3,8	1556072500
9,4	6	50	3	2,2	1556070940	28	12	71	3	4	1556072800
10	6	50	3	2,5	1556071000	30	12	71	3	4,2	1556073000
10,4	6	50	3	2,5	1556071040	31	12	71	3	4,2	1556073100
11,5	8	56	3	2,8	1556071150						

155 608**Anti-Vibration Kegelsenker HSS-E05+X.Cut 90° 3-FL-Schaft
HSS-E05 Counter Sinks+X.Cut 90° 3-FL-Shank**

- Ungleichmäßige Schneidaufteilung
- Schaft mit 3 Spannflächen
- Vibrationsfrei für bessere Oberflächen
- Hochpositiver Schnitt, hohe Laufruhe
- Senkwinkel 90°
- Oberfläche X5.Cut beschichtet
- Unequal division of flutes
- Shank with 3 flats
- No vibrations, better surface quality
- High positive cut, chatter free working
- Chamfering angle 90°
- With X5.Cut coating

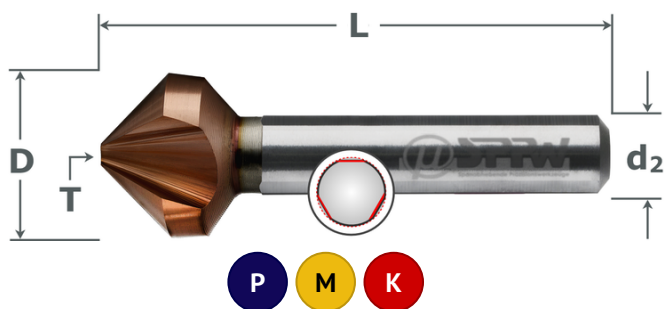

HSS E05	X Cut
DIN 335C	90°
z:3	3 FLATS
Anti Vibe	

ØD z9	Ød2 h9	L	z	T	Art. No.	ØD z9	Ød2 h9	L	z	T	Art. No.
10,4	6	50	3	2,5	1556081040	20,5	10	63	3	3,5	1556082050
12,4	8	56	3	2,8	1556081240	25	10	67	3	3,8	1556082500
16,5	10	60	3	3,2	1556081650	31	12	71	3	4,2	1556083100

154 620

Hochleistungs-Kegelsenker HSS-E08+X.Cut 3 Schneiden 90°
HSS-E08 High Performance Counter Sinks+X.Cut 3 Flutes 90°



- Harte/zähe Werkstoffe, Ni/Co
- 8% Co, mehr Härte/Hitzebeständigkeit
- Exzentrischer Hinterschliff
- Konstantes Profil
- Hochpositiver Schnitt, hohe Laufruhe
- Oberfläche X5.Cut beschichtet
- Hard/ductile materials, Ni/Co
- 8% Co, better heat resistance
- Excentric relief
- Constant profile
- High positive cut, chatter free working
- With X5.Cut coating

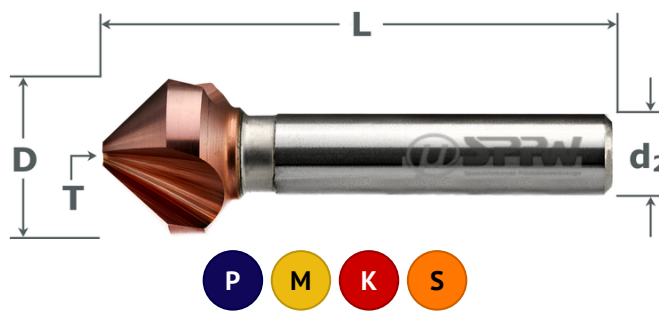

HSS E08	X Cut
DIN 335C	90°
z:3	ZYL

ØD z9	Ød2 h9	ØT max.	L	z	Art. No.
6,3	5	1,5	45	3	1546200630
8,3	6	2	50	3	1546200830
10,4	6	2,5	50	3	1546201040
12,4	8	2,8	56	3	1546201240
16,5	10	3,2	60	3	1546201650

ØD z9	Ød2 h9	ØT max.	L	z	Art. No.
20,5	10	3,5	63	3	1546202050
25	10	3,8	67	3	1546202500
31	12	4,2	71	3	1546203100
50	16	5	126	3	1546205000

154 610

Hochleistungs-Kegelsenker HSS-E08 3 Schneiden 90°
HSS-E08 High Performance Counter Sinks 3 Flutes 90°



- Harte/zähe Werkstoffe, Ni/Co
- 8%Co -höhere Hitzebeständigkeit
- Exzentrischer Hinterschliff
- Konstantes Profil
- Hochpositiver Schnitt, hohe Laufruhe
- Oberfläche blank
- Hard and ductile materials, Ni/Co
- 8% co ,better heat resistance
- Excentric relief and constant profile
- High positive cut, chatter free working
- Bright finish

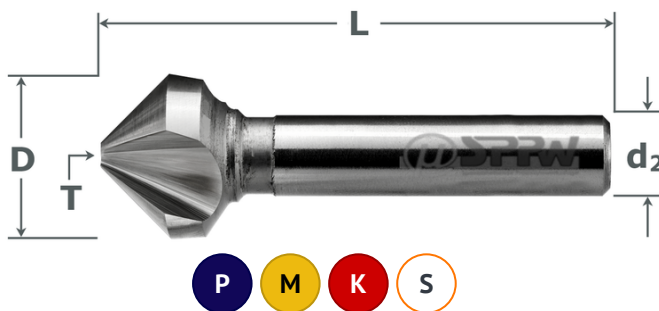

HSS E08	blank
DIN 335C	90°
z:3	ZYL

ØD z9	Ød2 h9	ØT max.	L	z	Art. No.
6,3	5	1,5	45	3	1546100630
8,3	6	2	50	3	1546100830
10,4	6	2,5	50	3	1546101040
12,4	8	2,8	56	3	1546101240
16,5	10	3,2	60	3	1546101650

ØD z9	Ød2 h9	ØT max.	L	z	Art. No.
20,5	10	3,5	63	3	1546102050
25	10	3,8	67	3	1546102500
31	12	4,2	71	3	1546103100
50	16	5	126	3	1546105000

154 607

Kegelsenker HSS-E05+X.Cut 3 Schneiden 90° HSS-E05 Counter Sinks+X.Cut 3 Flutes 90°



- Exzentrischer Hinterschliff
- Konstantes Profil
- Hochpositiver Schnitt, hohe Laufruhe
- Senkwinkel 90°
- Oberfläche X5.Cut beschichtet
- Excentric relief
- Constant profile
- High positive cut, chatter free working
- Chamfering angle 90°
- With X5.Cut coating

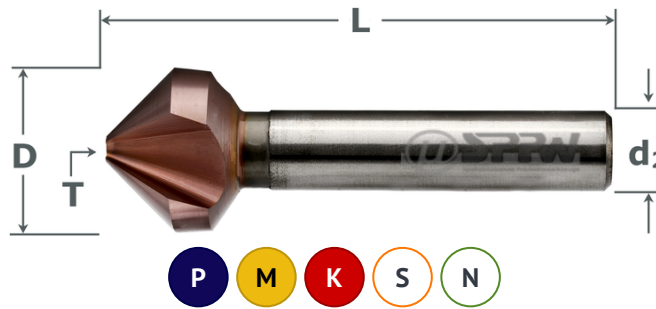

HSS E05	X Cut
DIN 335C	90°
z:3	ZYL

ØD z9	Ød2 h9	ØT max.	L	z	Art. No.	ØD z9	Ød2 h9	ØT max.	L	z	Art. No.
4,3	4	1,3	40	3	1546070430	14,4	8	2,9	56	3	1546071440
6,3	5	1,5	45	3	1546070630	16,5	10	3,2	60	3	1546071650
8,3	6	2	50	3	1546070830	20,5	10	3,5	63	3	1546072050
9,4	6	2,2	50	3	1546070940	25	10	3,8	67	3	1546072500
10,4	6	2,5	50	3	1546071040	31	12	4,2	71	3	1546073100
11,5	8	2,8	56	3	1546071150	35	16	4,5	103	3	1546073500
12,4	8	2,8	56	3	1546071240	40	16	4,5	118	3	1546074000
13,4	8	2,9	56	3	1546071340	50	16	5	126	3	1546075000

154 304

Kegelsenker HSS-E05+X.Cut 3 Schneiden Lang HSS-E05 Counter Sinks+X.Cut 3 Flutes Long Series



- Lange Ausführung, verstärkter Schaft
- Exzentrisch hinterschliffen
- Konstantes Profil
- Hochpositiver Schnitt, hohe Laufruhe
- Oberfläche X5.Cut beschichtet
- Long series, reinforced shank
- Excentric relief
- Constant profile
- High positive cut, chatter free working
- With X5.Cut coating

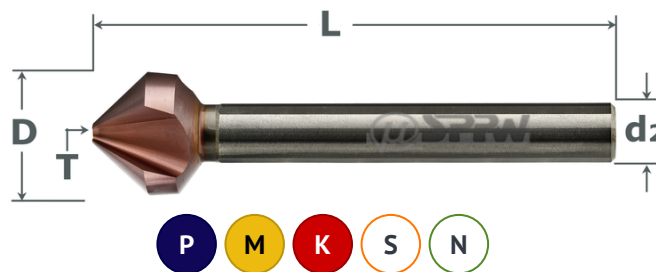

HSS E05	X Cut
90°	z:3
ZYL	L lang

ØD z9	Ød2 h9	ØT max.	L	z	Art. No.	ØD z9	Ød2 h9	ØT max.	L	z	Art. No.
6,3	6	1,5	84	3	1543040630	16,5	12	3,2	112	3	1543041650
8,3	8	2	85	3	1543040830	20,5	12	3,5	115	3	1543042050
10,4	10	2,5	87	3	1543041040	25	12	3,8	118	3	1543042500
12,4	10	2,8	108	3	1543041240						

154 700

Kegelsenker HSS-E05+A.Cut 3 Schneiden 90° HSS-E05 Counter Sinks+A.Cut 3 Flutes 90°



- Exzentrischer Hinterschliff
- Konstantes Profil
- Hochpositiver Schnitt, hohe Laufruhe
- Senkwinkel 90°
- Oberfläche A.Cut
- Excentric relief
- Constant profile
- High positive cut, chatter free working
- Chamfering angle 90°
- With A.Cut coating

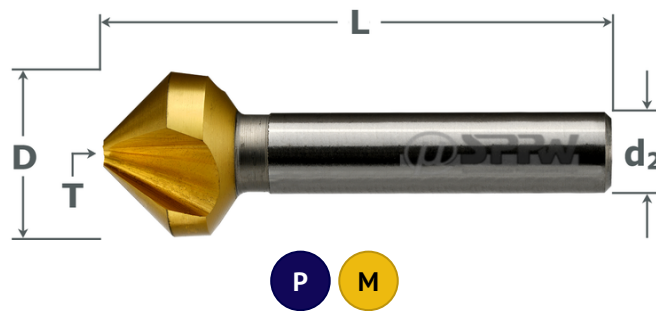

HSS E05	A Cut
DIN 335C	90°
z:3	ZYL

ØD z9	Ød2 h9	ØT max.	L	z	Art. No.	ØD z9	Ød2 h9	ØT max.	L	z	Art. No.
4,3	4	1,3	40	3	1547000430	13,4	8	2,9	56	3	1547001340
5	4	1,5	40	3	1547000500	14,4	8	2,9	56	3	1547001440
5,3	4	1,5	40	3	1547000530	15	10	3,2	60	3	1547001500
5,8	5	1,5	45	3	1547000580	16,5	10	3,2	60	3	1547001650
6	5	1,5	45	3	1547000600	19	10	3,5	63	3	1547001900
6,3	5	1,5	45	3	1547000630	20,5	10	3,5	63	3	1547002050
7	6	1,8	50	3	1547000700	23	10	3,8	67	3	1547002300
7,3	6	1,8	50	3	1547000730	25	10	3,8	67	3	1547002500
8	6	2	50	3	1547000800	26	10	3,8	67	3	1547002600
8,3	6	2	50	3	1547000830	28	12	4	71	3	1547002800
9	6	2,2	50	3	1547000900	30	12	4,2	71	3	1547003000
9,4	6	2,2	50	3	1547000940	31	12	4,2	71	3	1547003100
10	6	2,5	50	3	1547001000	35	16	4,5	103	3	1547003500
10,4	6	2,5	50	3	1547001040	40	16	4,5	118	3	1547004000
11,5	8	2,8	56	3	1547001150	50	16	5	126	3	1547005000
12	8	2,8	56	3	1547001200	63	16	10	140	3	1547006300
12,4	8	2,8	56	3	1547001240	80	16	14	166	3	1547008000

154 303

Kegelsenker HSS-E05 3 Schneiden Lang HSS-E05 Counter Sinks 3 Flutes Long Series



- Lange Ausführung, verstärkter Schaft
- Exzentrisch hinterschliffen
- Konstantes Profil
- Hochpositiver Schnitt, hohe Laufruhe
- Oberfläche blank

- Long series, reinforced shank
- Excentric relief and constant profile
- High positive cut, chatter free
- Bright finish



HSS E05	blank
90°	z:3
ZYL	L lang

ØD z9	Ød2 h9	ØT max.	L	z	Art. No.	ØD z9	Ød2 h9	ØT max.	L	z	Art. No.
6,3	6	1,5	84	3	1543030630	16,5	12	3,2	112	3	1543031650
8,3	8	2	85	3	1543030830	20,5	12	3,5	115	3	1543032050
10,4	10	2,5	87	3	1543031040	25	12	3,8	118	3	1543032500
12,4	10	2,8	108	3	1543031240						



- Exzentrischer Hinterschliff
- Konstantes Profil
- Hochpositiver Schnitt, hohe Laufruhe
- Senkwinkel 90°
- Oberfläche blank
- Excentric relief
- Constant profile
- High positive cut, chatter free working
- Chamfering angle 90°
- Bright finish

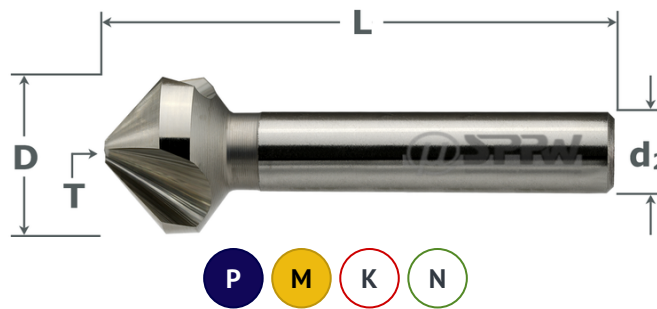

HSS E05	blank
DIN 335C	90° etc.
z3	ZYL

154600 - 90°

ØD z9	Ød2 h9	ØT max.	L	z	Art. No.	ØD z9	Ød2 h9	ØT max.	L	z	Art. No.
4,3	4	1,3	40	3	1546000430	13,4	8	2,9	56	3	1546001340
5	4	1,5	40	3	1546000500	14,4	8	2,9	56	3	1546001440
5,3	4	1,5	40	3	1546000530	15	10	3,2	60	3	1546001500
5,8	5	1,5	45	3	1546000580	16,5	10	3,2	60	3	1546001650
6	5	1,5	45	3	1546000600	19	10	3,5	63	3	1546001900
6,3	5	1,5	45	3	1546000630	20,5	10	3,5	63	3	1546002050
7	6	1,8	50	3	1546000700	23	10	3,8	67	3	1546002300
7,3	6	1,8	50	3	1546000730	25	10	3,8	67	3	1546002500
8	6	2	50	3	1546000800	26	10	3,8	67	3	1546002600
8,3	6	2	50	3	1546000830	28	12	4	71	3	1546002800
9	6	2,2	50	3	1546000900	30	12	4,2	71	3	1546003000
9,4	6	2,2	50	3	1546000940	31	12	4,2	71	3	1546003100
10	6	2,5	50	3	1546001000	35	16	4,5	103	3	1546003500
10,4	6	2,5	50	3	1546001040	40	16	4,5	118	3	1546004000
11,5	8	2,8	56	3	1546001150	50	16	5	126	3	1546005000
12	8	2,8	56	3	1546001200	63	16	10	140	3	1546006300
12,4	8	2,8	56	3	1546001240	80	16	14	166	3	1546008000

154630 - 30°

ØD z9	Ød2 h9	ØT max.	L	z	Art. No.	ØD z9	Ød2 h9	ØT max.	L	z	Art. No.
6,3	5	2	50	3	1546300630	16,5	10	4	76	3	1546301650
12,4	8	3	65	3	1546301240	25	10	6	90	3	1546302500

154650 - 60°

ØD z9	Ød2 h9	ØT max.	L	z	Art. No.	ØD z9	Ød2 h9	ØT max.	L	z	Art. No.
6,3	5	1,5	47	3	1546500630	16,5	10	3,2	65	3	1546501650
8,3	6	2	52	3	1546500830	20,5	10	3,5	69	3	1546502050
10,4	6	2,5	53	3	1546501040	25	10	3,8	75	3	1546502500
12,4	8	2,8	60	3	1546501240	31	12	4,2	81	3	1546503100



- Exzentrischer Hinterschliff
- Konstantes Profil
- Hochpositiver Schnitt, hohe Laufruhe
- Senkwinkel 90°
- Oberfläche blank
- Excentric relief
- Constant profile
- High positive cut, chatter free working
- Chamfering angle 90°
- Bright finish



HSS E05	blank
DIN 335C	90° etc.
z:3	ZYL

154660 - 82° Aviation

ØD z9	Ød2 h9	ØT max.	L	z	Art. No.
6,3	5	1,5	45	3	1546600630
8,3	6	2	50	3	1546600830
10,4	6	2,5	50	3	1546601040
12,4	8	2,8	56	3	1546601240

ØD z9	Ød2 h9	ØT max.	L	z	Art. No.
16,5	10	3,2	61	3	1546601650
20,5	10	3,5	64	3	1546602050
25	10	3,8	68	3	1546602500
31	12	4,2	73	3	1546603100

154910 - 100° Aviation

ØD z9	Ød2 h9	ØT max.	L	z	Art. No.
6,3	5	1,5	44	3	1549100630
8,3	6	2	49	3	1549100830
10,4	6	2,5	49	3	1549101040
12,4	8	2,8	55	3	1549101240

ØD z9	Ød2 h9	ØT max.	L	z	Art. No.
16,5	10	3,2	59	3	1549101650
20,5	10	3,5	62	3	1549102050
25	10	3,8	65	3	1549102500
31	12	4,2	68	3	1549103100

154800 - 120°

ØD z9	Ød2 h9	ØT max.	L	z	Art. No.
6,3	5	1,5	43	3	1548000630
8,3	6	2	48	3	1548000830
10,4	6	2,5	48	3	1548001040
12,4	8	2,8	54	3	1548001240

ØD z9	Ød2 h9	ØT max.	L	z	Art. No.
16,5	10	3,2	57	3	1548001650
20,5	10	3,5	59	3	1548002050
25	10	3,8	62	3	1548002500
31	12	4,2	65	3	1548003100

INFO



Kegelsenker aus HSS-E mit 3 Schneiden in Sätzen

- Senkwinkel 60° - 82° - 90° - 100° und 120°
- Blank, A.Cut oder X.Cut beschichtet
- Verschiedene Zusammenstellungen

HSS-E Counter Sinks with 3 Flutes in Sets

- Chamfering angles 60° - 82° - 90° - 100° and 120°
- Uncoated, A.Cut or X.Cut coating
- Different compositions





- Entgratarbeiten und kleine Fasen
- Leichtmetalle und Kunststoffe
- Glatte und gratfreie Oberflächen
- Senkwinkel 90°
- Oberfläche blank/A.Cut beschichtet
- Deburring small chamfers
- Light alloys and plastics
- Surface obtained is smooth, burr free
- Chamfering angle 90°
- Bright finish/A.Cut coating

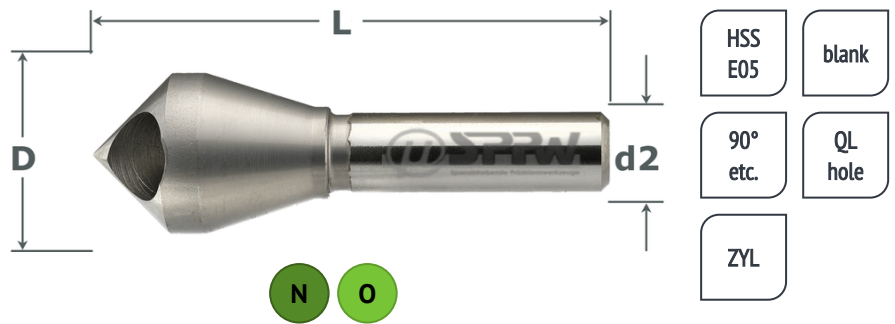

153000 - 90°

ØD 0.3	Ød2 h9	Bereich capacity	L	Art. No.
10	6	2-5	45	1530001000
15	6	6-14	48	1530001500
20	10	8-18	65	1530002000
25	12	10-23	78	1530002500
28	12	11-26	78	1530002800

ØD 0.3	Ød2 h9	Bereich capacity	L	Art. No.
30	12	12-28	87	1530003000
35	16	14-33	106	1530003500
40	16	16-38	121	1530004000
50	16	20-48	130	1530005000

153300 - 60°

ØD 0.3	Ød2 h9	Bereich capacity	L	Art. No.
10	6	5-9	49	1533001000
15	8	8-14	60	1533001500
20	10	10-18	71	1533002000

ØD 0.3	Ød2 h9	Bereich capacity	L	Art. No.
25	12	12-23	85	1533002500
30	12	15-28	96	1533003000
35	16	17-33	117	1533003500

153080 - 82° Aviation

ØD 0.3	Ød2 h9	Bereich capacity	L	Art. No.
10	6	4-9	46	1530801000
15	8	6-14	56	1530801500
20	10	8-18	66	1530802000

ØD 0.3	Ød2 h9	Bereich capacity	L	Art. No.
25	12	10-23	76	1530802500
30	12	12-28	89	1530803000
35	16	14-33	108	1530803500

153010 - 100° Aviation

ØD 0.3	Ød2 h9	Bereich capacity	L	Art. No.
10	6	4-9	44	1530101000
15	8	6-14	54	1530101500
20	10	7-18	63	1530102000

ØD 0.3	Ød2 h9	Bereich capacity	L	Art. No.
25	12	9-23	76	1530102500
30	12	11-28	85	1530103000
35	16	13-33	103	1530103500

153400 - 120°

ØD 0.3	Ød2 h9	Bereich capacity	L	Art. No.
10	6	4-9	43	1534001000
15	8	5-14	52	1534001500
20	10	6-18	61	1534002000

ØD 0.3	Ød2 h9	Bereich capacity	L	Art. No.
25	12	8-23	68	1534002500
30	12	10-28	82	1534003000
35	16	12-33	99	1534003500

153 700

Querlochsenker HSS-E05+A.Cut 90° HSS-E05 Hole Counter Sinks+A.Cut 90°



- Entgratarbeiten und kleine Fasen
- Leichtmetalle und Kunststoffe
- Glatte, gratfreie Oberflächen
- Senkwinkel 90°
- Oberfläche A.Cut beschichtet
- Deburring and small chamfers
- Light alloys and plastics
- Surface obtained is smooth, burr free
- Chamfering angle 90°
- With A.Cut coating

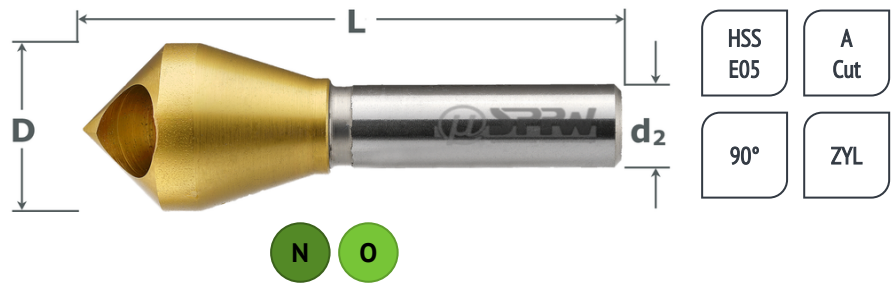

ØD	Ød2	Bereich	L	Art. No.	ØD	Ød2	Bereich	L	Art. No.
0.3	h9	capacity			0.3	h9	capacity		
10	6	2-5	45	1537001000	30	12	12-28	87	1537003000
15	6	6-14	48	1537001500	35	16	14-33	106	1537003500
20	10	8-18	65	1537002000	40	16	16-38	121	1537004000
25	12	10-23	78	1537002500	50	16	20-48	130	1537005000
28	12	11-26	78	1537002800					

F

INFO



Kegelsenker aus HSS-E mit Querloch in Sätzen

- Senkwinkel 60° - 82° - 90° - 100° und 120°
- Blank oder mit A.Cut Beschichtung
- Verschiedene Zusammenstellungen

HSS-E Counter Sinks with Hole in Sets

- Chamfering angles 60° - 82° - 90° - 100° and 120°
- Uncoated or with A.Cut coating
- Different compositions





- Bohren, Senken in dünnem Material
- Laminates, Aluminium, Holz
- Mehrmaliges Nachschleifen möglich
- Senkwinkel 90°
- Oberfläche blank

- Drilling and sinking in thin Material
- Laminates, aluminum, wood
- Multiple easy regrinds possible
- Chamfering angles 90°
- Bright finish



HSS E05	blank
90° etc.	z:1
ZYL	

153900 - 90°

ØD 0.3	Ød1	Ød2 h9	L	Art. No.
4	1	4	40	1539000400
5	1	5	40	1539000500
6	1	6	40	1539000600
8	1	6	40	1539000800
10	1	6	45	1539001000
12	2	8	50	1539001200
15	2	8	55	1539001500

ØD 0.3	Ød1	Ød2 h9	L	Art. No.
20	2	10	65	1539002000
25	3	12	78	1539002500
30	3	12	88	1539003000
35	4	16	103	1539003500
40	5	16	118	1539004000
50	12	16	126	1539005000

154030 - 30°

ØD 0.3	Ød1	Ød2 h9	L	Art. No.
10	5,5	6	49	1540301000
15	8,5	8	60	1540301500
20	11	10	72	1540302000

ØD 0.3	Ød1	Ød2 h9	L	Art. No.
25	13,5	12	78	1540302500
30	16,5	12	99	1540303000

154045 - 45°

ØD 0.3	Ød1	Ød2 h9	L	Art. No.
6	2	6	43	1540450600
10	3	6	49	1540451000
15	4,5	8	61	1540451500

ØD 0.3	Ød1	Ød2 h9	L	Art. No.
20	6	10	72	1540452000
25	7,5	12	87	1540452500
30	9	12	99	1540453000

153950 - 60°

ØD 0.3	Ød1	Ød2 h9	L	Art. No.
6	1	6	43	1539500600
10	1	6	49	1539501000
12	2	8	54	1539501200
15	2	8	60	1539501500

ØD 0.3	Ød1	Ød2 h9	L	Art. No.
20	2	10	72	1539502000
25	3	12	78	1539502500
30	3	12	99	1539503000

KGS z1

Kegelsenker HSS-E05 1 Schneide HSS-E05 Counter Sinks Single Flute 90°



- Bohren, Senken in dünnem Material
- Laminat, Aluminium, Holz
- Mehrmaliges Nachschleifen möglich
- Senkwinkel 90°
- Oberfläche blank

- Drilling and sinking in thin Material
- Laminates, aluminum, wood
- Multiple easy regrinds possible
- Chamfering angles 90°
- Bright finish

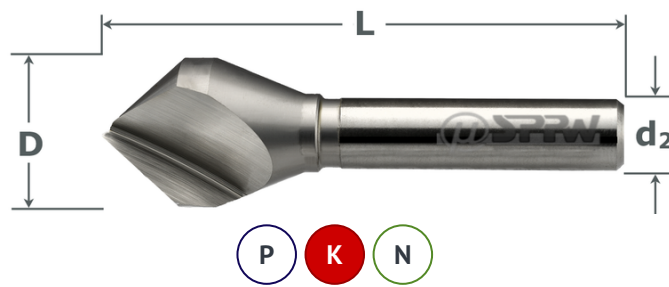

HSS E05	blank
90° etc.	z:1
ZYL	



153980 - 82° Aviation

ØD	Ød1	Ød2	L	Art. No.
0.3		h9		
6	1	6	41	1539800600
10	1	6	46	1539801000
12	2	8	51	1539801200
15	2	8	56	1539801500

ØD	Ød1	Ød2	L	Art. No.
0.3		h9		
20	2	10	66	1539802000
25	3	12	80	1539802500
30	3	12	90	1539803000

154100 - 120°

ØD	Ød1	Ød2	L	Art. No.
0.3		h9		
10	1	6	43	1541001000
12	2	8	47	1541001200
15	2	8	52	1541001500

ØD	Ød1	Ød2	L	Art. No.
0.3		h9		
20	2	10	61	1541002000
25	3	12	73	1541002500
30	3	12	66	1541003000

INFO



Kegelsenker aus HSS-E mit 1 Schneide in Sätzen

- Senkwinkel 30° - 45° - 60° - 82° - 90° - 100° und 120°
- Blank oder mit A.Cut Beschichtung
- Verschiedene Zusammenstellungen

HSS-E Single Flute Counter Sinks in Sets

- Chamfering angles 30° - 45° - 60° - 82° - 90° - 100° - 120°
- Uncoated or with A.Cut coating
- Different compositions



655 200

Flachsenker VHM 180°
Carbide Piloted Counter Bores 180°



- Flachsenker mit Führungszapfen
- Innensechskant-, Zylinderschrauben
- Für Durchgangsbohrungen (Fein)
- Senkwinkel 180°
- Oberfläche blank

- Counter bores with fixed pilot
- For cheese, fillister screw caps
- For through holes (Fine)
- Chamfering angle 180°
- Bright finish

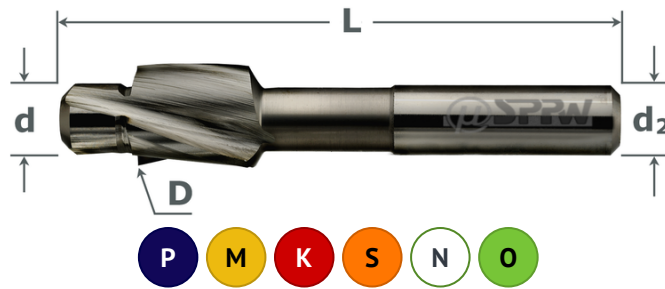

VHM	blank
DIN 373	180°
z:3	ZYL

ØM	ØD z9	Ød e8	Ød2	L	Art. No.	ØM	ØD z9	Ød e8	Ød2	L	Art. No.
3,0	6,0	3,2	6	71	655200030F	8,0	15,0	8,4	12,5	100	655200080F
4,0	8,0	4,3	8	71	655200040F	10,0	18,0	10,5	12,5	100	655200100F
5,0	10,0	5,3	10	80	655200050F	12,0	20,0	13,0	12,5	100	655200120F
6,0	11,0	6,4	11	80	655200060F						

F

155 206

Flachsenker HSS-E05+A.Cut 180°
HSS-E05 Piloted Counter Bores+A.Cut 180°



- Flachsenker mit Führungszapfen
- Innensechskant-, Zylinderschraube
- Für Durchgangsbohrungen (F,M)
- Gewindekernlöcher (K)
- Senkwinkel 180°
- Oberfläche A.Cut Beschichtung

- Counter bores with fixed pilot
- For cheese, fillister screw caps
- For through holes (Fine, Medium)
- Tapping holes (K)
- Chamfering angle 180°
- With A.Cut coating

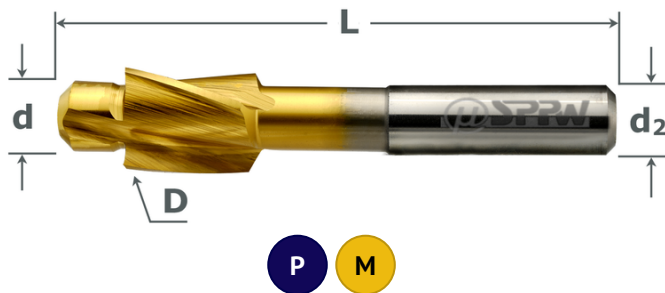

HSS E05	A Cut
DIN 373	180°
z:3	ZYL

ØM	ØD z9	Ød e8	Ød2 z9	L	z	Typ	Art. No.	ØM	ØD z9	Ød e8	Ød2 z9	L	z	Typ	Art. No.
2	4,3	2,2	4,3	56	3	F	155206020F	5	10	5,5	10	80	3	M	155206050M
2	4,3	2,4	4,3	56	3	M	155206020M	6	11	6,4	11	80	3	F	155206060F
2,5	5	2,7	5	56	3	F	155206025F	6	11	6,6	11	80	3	M	155206060M
2,5	5	2,9	5	56	3	M	155206025M	8	15	8,4	12,5	100	3	F	155206080F
3	6	3,2	6	71	3	F	155206030F	8	15	9	12,5	100	3	M	155206080M
3	6	3,4	6	71	3	M	155206030M	10	18	10,5	12,5	100	3	F	155206100F
4	8	4,3	8	71	3	F	155206040F	10	18	11	12,5	100	3	M	155206100M
4	8	4,5	8	71	3	M	155206040M	12	20	13	12,5	100	3	F	155206120F
5	10	5,3	10	80	3	F	155206050F	12	20	14	12,5	100	3	M	155206120M

155 200

Flachsenker HSS-E05 180°
HSS-E05 Piloted Counter Bores 180°



- Flachsenker mit Führungszapfen
- Innensechskant-, Zylinderschraube
- Für Durchgangsbohrungen (F,M)
- Gewindekernlöcher (K)
- Senkwinkel 180°
- Oberfläche blank

- Counter bores with fixed pilot
- For cheese, fillister screw caps
- For through holes (Fine, Medium)
- Tapping holes (K)
- Chamfering angle 180°
- Bright finish



HSS E05	blank
DIN 373	180°
z:3	ZYL



ØM	ØD	Ød	Ød2	L	z	Typ	Art. No.
	z9	e8	z9				
1	2,2	1,1	2,2	45	3	F	155200010F
1,2	2,5	1,3	2,5	45	3	F	155200012F
1,4	2,8	1,5	2,8	45	3	F	155200014F
1,6	3,3	1,7	3,3	56	3	F	155200016F
1,7	3,8	1,8	3,8	56	3	F	155200017F
2	4,3	2,2	4,3	56	3	F	155200020F
2	4,3	2,4	4,3	56	3	M	155200020M
2,2	4,6	2,4	4,6	56	3	F	155200022F
2,5	5	2,7	5	56	3	F	155200025F
2,5	5	2,9	5	56	3	M	155200025M
2,6	5,5	2,8	5,5	71	3	F	155200026F
2,6	5,5	3	5,5	71	3	M	155200026M
3	6	3,2	6	71	3	F	155200030F
3	6	2,5	6	71	3	K	155200030K
3	6	3,4	6	71	3	M	155200030M
3,5	6,5	3,7	6,5	71	3	F	155200035F
3,5	6,5	2,9	6,5	71	3	K	155200035K
3,5	6,5	3,9	6,5	71	3	M	155200035M

ØM	ØD	Ød	Ød2	L	z	Typ	Art. No.
	z9	e8	z9				
4	8	4,3	8	71	3	F	155200040F
4	8	3,3	8	71	3	K	155200040K
4	8	4,5	8	71	3	M	155200040M
5	10	5,3	10	80	3	F	155200050F
5	10	4,2	10	80	3	K	155200050K
5	10	5,5	10	80	3	M	155200050M
6	11	6,4	11	80	3	F	155200060F
6	11	5	11	80	3	K	155200060K
6	11	6,6	11	80	3	M	155200060M
8	15	8,4	12,5	100	3	F	155200080F
8	15	6,8	12,5	100	3	K	155200080K
8	15	9	12,5	100	3	M	155200080M
10	18	10,5	12,5	100	3	F	155200100F
10	18	8,5	12,5	100	3	K	155200100K
10	18	11	12,5	100	3	M	155200100M
12	20	13	12,5	100	3	F	155200120F
12	20	10,2	12,5	100	3	K	155200120K
12	20	14	12,5	100	3	M	155200120M



— INFO —



Zapfensenker aus HSS-E in Sätzen

- Senkwinkel 90° - 180°
- Blank oder mit A.Cut Beschichtung
- Verschiedene Zusammenstellungen

HSS-E Piloted Counter Sinks in Sets

- Chamfering angles 90° - 180°
- Uncoated or with A.Cut coating
- Different compositions



155 806

Zapfensenker HSS-E05+A.Cut 90°
HSS-E05 Piloted Counter Bores+A.Cut 90°



- Senker mit Führungszapfen
- Versenken von Schrauben
- Für Durchgangsbohrungen (F, M)
- Mit A.Cut Beschichtung
- Counter bores with fixed pilot
- Designed to bore holes
- For through holes (Fine, Medium)
- With A.Cut coating

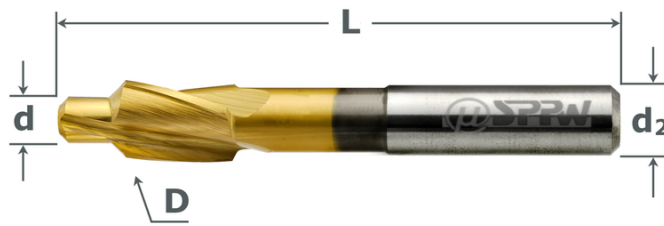

HSS E05	A Cut
DIN 1866	90°
z:3	ZYL



ØM	ØD	Ød	Ød2	L	z	Typ	Art. No.
	z9	e8	z9				
2	4,3	2,2	4,3	56	3	F	155806020F
2,5	5	2,7	5	56	3	F	155806025F
3	6	3,2	6	71	3	F	155806030F
3	6,5	3,4	6,5	71	3	M	155806030M
4	8	4,3	8	71	3	F	155806040F
4	8,6	4,5	8,6	71	3	M	155806040M
5	10	5,3	10	80	3	F	155806050F

ØM	ØD	Ød	Ød2	L	z	Typ	Art. No.
	z9	e8	z9				
5	10,4	5,5	10,4	80	3	M	155806050M
6	11,5	6,4	11,5	80	3	F	155806060F
6	12,4	6,6	12,4	80	3	M	155806060M
8	15	8,4	12,5	100	3	F	155806080F
8	16,4	9	12,5	100	3	M	155806080M
10	19	10,5	12,5	100	3	F	155806100F
10	20,4	11	12,5	100	3	M	155806100M

F

155 800

Zapfensenker HSS-E05 90°
HSS-E05 Piloted Counter Bores 90°



- Senker mit Führungszapfen
- Versenken von Schrauben
- Für Durchgangsbohrungen (F,M)
- Gewindekernlöcher (K)
- Senkwinkel 90°
- Oberfläche blank
- Counter bores with fixed pilot
- Designed to bore holes
- For through holes (Fine, Medium)
- Tapping holes (K)
- Chamfering angle 90°
- Bright finish



HSS E05	blank
DIN 1866	90°
z:3	ZYL



ØM	ØD	Ød	Ød2	L	z	Typ	Art. No.
	z9	e8	z9				
1	2	1,1	2	45	3	F	155800010F
1,2	2,5	1,3	2,5	45	3	F	155800012F
1,4	2,8	1,5	2,8	45	3	F	155800014F
1,6	3,3	1,7	3,3	56	3	F	155800016F
1,8	3,8	1,9	3,8	56	3	F	155800018F
1,8	4,2	2	4,2	56	3	M	155800018M
2	4,3	2,2	4,3	56	3	F	155800020F
2	4,6	2,4	4,6	56	3	M	155800020M
2,5	5	2,7	5	56	3	F	155800025F
2,5	5,7	2,9	5,7	56	3	M	155800025M
3	6	3,2	6	71	3	F	155800030F
3	6	2,5	6	71	3	K	155800030K
3	6,5	3,4	6,5	71	3	M	155800030M
3,5	7	3,7	7	71	3	F	155800035F
3,5	7	2,9	7	71	3	K	155800035K
3,5	7,6	3,9	7,6	71	3	M	155800035M

ØM	ØD	Ød	Ød2	L	z	Typ	Art. No.
	z9	e8	z9				
4	8	4,3	8	71	3	F	155800040F
4	8	3,3	8	71	3	K	155800040K
4	8,6	4,5	8,6	71	3	M	155800040M
5	10	5,3	10	80	3	F	155800050F
5	10	4,2	10	80	3	K	155800050K
5	10,4	5,5	10,4	80	3	M	155800050M
6	11,5	6,4	11,5	80	3	F	155800060F
6	11,5	5	11,5	80	3	K	155800060K
6	12,4	6,6	12,4	80	3	M	155800060M
8	15	8,4	12,5	100	3	F	155800080F
8	15	6,8	12,5	100	3	K	155800080K
8	16,4	9	12,5	100	3	M	155800080M
10	19	10,5	12,5	100	3	F	155800100F
10	19	8,5	12,5	100	3	K	155800100K
10	20,4	11	12,5	100	3	M	155800100M



[DE] **Multifunktion**
[EN] **Multifunction**

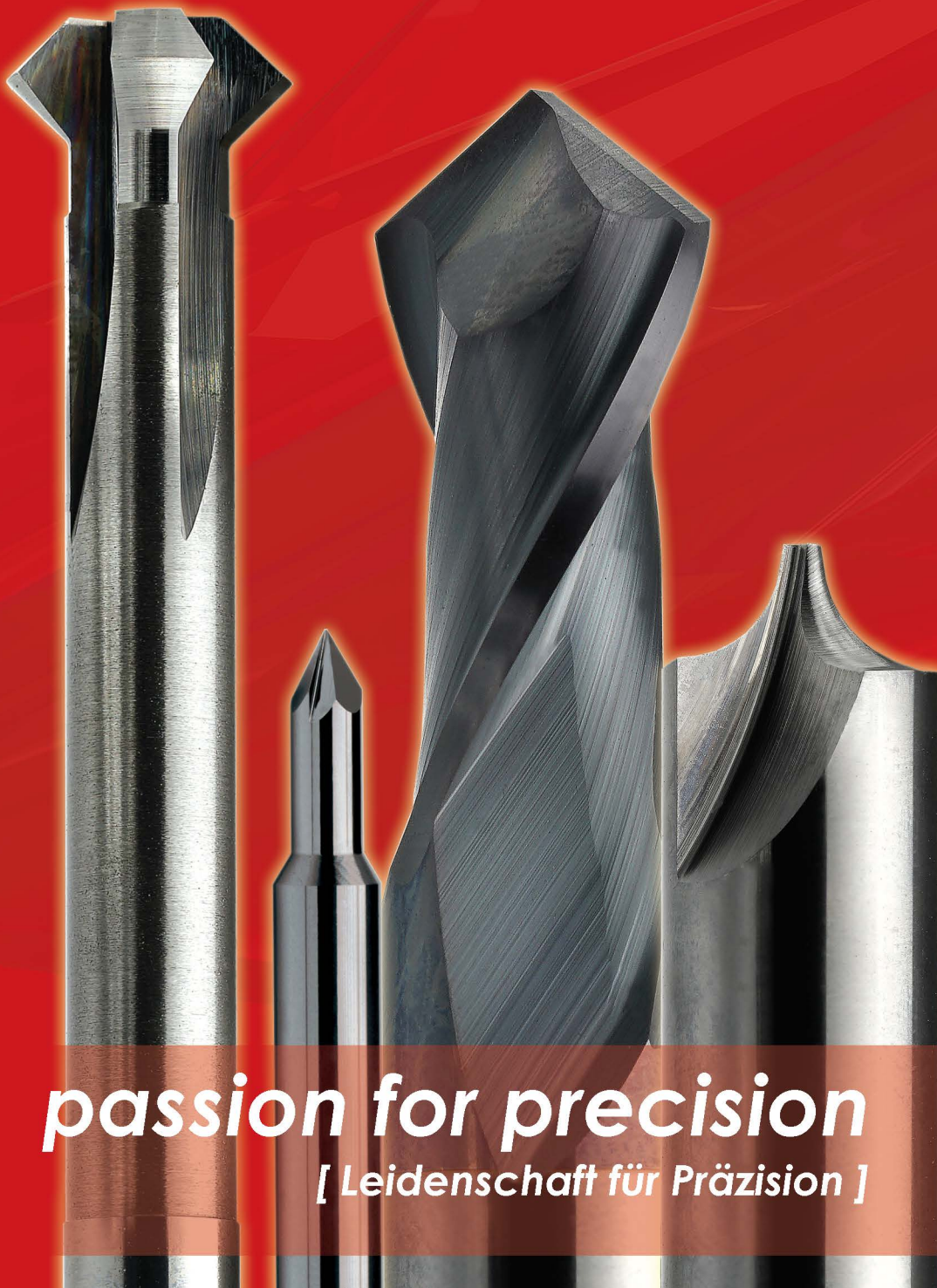

passion for precision
[Leidenschaft für Präzision]



Multifunktionswerkzeuge

Multifunction Tools

Art.No./Page

● ● ● ● ● ●	● ●		VHM	poliert	90° etc.	z:2	DIN 6535HA	Multi V	668 090 Seite G 1
● ● ● ● ● ●	● ●		VHM	poliert	90°	z:2	DIN 6535HA	Multi V L lang	668 089 Seite G 1
● ● ● ● ● ●	● ●		VHM	poliert	40°	z:2	DIN 6535HA	Multi V	668 040 Seite G 2
● ● ● ● ● ●	● ●		VHM	poliert	60°	z:2	DIN 6535HA	Multi V	668 088 Seite G 2
● ● ● ● ● ●	● ●		VHM	poliert	100°	z:2	DIN 6535HA	Multi V	668 095 Seite G 2
● ● ● ● ● ●	● ●		VHM	poliert	120°	z:2	DIN 6535HA	Multi V	668 092 Seite G 3
● ● ● ● ● ● ● ●	● ●		VHM	X Cut	90° etc.	z:2	DIN 6535HA	Multi V	678 090 Seite G 4
● ● ● ● ● ● ● ●	● ●		VHM	X Cut	90°	z:2	DIN 6535HA	Multi V L lang	678 089 Seite G 4
● ● ● ● ● ● ● ●	● ●		VHM	X Cut	40°	z:2	DIN 6535HA	Multi V	678 040 Seite G 5
● ● ● ● ● ● ● ●	● ●		VHM	X Cut	60°	z:2	DIN 6535HA	Multi V	678 088 Seite G 5
● ● ● ● ● ● ● ●	● ●		VHM	X Cut	100°	z:2	DIN 6535HA	Multi V	678 095 Seite G 5
● ● ● ● ● ● ● ●	● ●		VHM	X Cut	120°	z:2	DIN 6535HA	Multi V	678 092 Seite G 6
● ● ● ● ● ● ● ●	● ●		HSS E05	X Cut	90°	z:2	ZYL	Combi Mag	157 007 Seite G 7

Entgratwerkzeuge VHM





Carbide Deburring Tools

Art.No./Page

● ● ● ● ● ●	● ●		VHM	poliert	90°	z: 1-3	DIN 6535HA	Micro	668 480 Seite G 8
● ● ● ● ● ● ● ●	● ●		VHM	X Cut	90°	z: 1-3	DIN 6535HA	Micro	678 480 Seite G 8
● ● ● ● ● ●	● ●		VHM	poliert	90°	z:4	DIN 6535HA	L lang	668 490 Seite G 9
● ● ● ● ● ● ● ●	● ●		VHM	X Cut	90°	z: 3-4	DIN 6535HA	L lang	678 490 Seite G 9
● ● ● ● ● ●	● ●		VHM	poliert	60° 120°	z: 3-4	DIN 6535HA	L lang	668 460 Seite G 10
● ● ● ● ● ● ● ●	● ●		VHM	X Cut	60° 120°	z: 3-4	DIN 6535HA	L lang	678 460 Seite G 10

P M K H S N O







Multifunktion & Entgraten - Multifunction and Deburring

●	○	○			●	○		VHM	poliert	z:3	DIN 6535HA	O Ring	668 410 Seite G 11	
●	●	●	○	●				VHM	X Cut	z:3	DIN 6535HA	L lang Radius	678 560 Seite G 12	
●	○	○			●	○		VHM	poliert	Radius	z:2	DIN 6535HA	micro	668 550 Seite G 13
●	●	●	○	●				VHM	X Cut	Radius	z:2	DIN 6535HA	micro	678 550 Seite G 14
●	●	●	●	●				VHM	X Cut	60°	z:3	DIN 6535HA		678 063 Seite G 15
●	●	●	○	●				VHM	X Cut	60°	z: 4-6	DIN 6535HA	DIN 6535HB	678 060 Seite G 15
●	●	●	●	●				VHM	X Cut	90°	z:3	DIN 6535HA		678 073 Seite G 16
●	●	●	○	●				VHM	X Cut	90°	z: 4-6	DIN 6535HA	DIN 6535HB	678 070 Seite G 16

Gravierwerkzeuge VHM

Carbide Engraving Tools

Art.No./Page

○	○				●	●		VHM	poliert	40° etc.	z:1	DIN 6535HA	690 854 Seite G 17
○	○				●	●		VHM	poliert	60°	z:1	DIN 6535HA	690 856 Seite G 17
○	○				●	●		VHM	poliert	90°	z:1	DIN 6535HA	690 859 Seite G 17
●	●				●			VHM	X Cut	40° etc.	z:1	DIN 6535HA	690 854 X Seite G 18
●	●				●			VHM	X Cut	60°	z:1	DIN 6535HA	690 856 X Seite G 18
●	●				●			VHM	X Cut	90°	z:1	DIN 6535HA	690 859 X Seite G 18



- Fräsen, Bohren, Senken, 1 Werkzeug
- Besonders geeignet auf CNC-BAZ
- Weniger Rüstzeit und Bevorratung
- Senkwinkel 90° etc.
- Oberfläche blank
- Milling, drilling, chamfering, 1 tool
- Use on CNC or automatic machines
- Short set up-, work time, easy storage
- Chamfering angle 90° etc.
- Bright finish

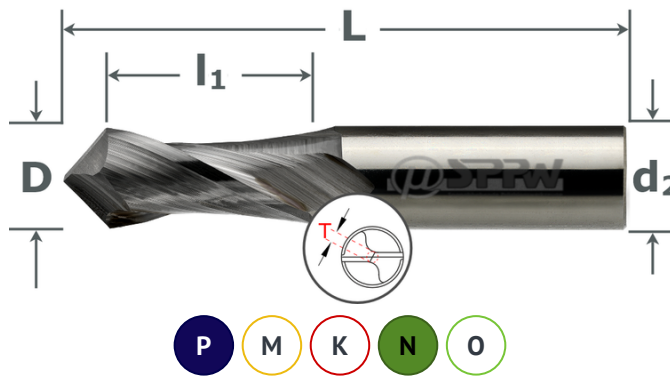

VHM	poliert
90° etc.	z:2
DIN 6535HA	Multi V

668090 - 90°

ØD h9	Ød2 h6	L	l1	z	T	a	Art. No.	ØD h9	Ød2 h6	L	l1	z	T	a	Art. No.
0,1	3	39	0,2	2	0,01	90°	6680900010	2,2	3	39	4,4	2	0,22	90°	6680900220
0,2	3	39	0,4	2	0,02	90°	6680900020	2,3	3	39	4,6	2	0,23	90°	6680900230
0,3	3	39	0,6	2	0,03	90°	6680900030	2,4	3	39	4,8	2	0,24	90°	6680900240
0,4	3	39	0,8	2	0,04	90°	6680900040	2,5	3	39	5	2	0,25	90°	6680900250
0,5	3	39	1	2	0,05	90°	6680900050	2,6	3	39	5,2	2	0,26	90°	6680900260
0,6	3	39	1,2	2	0,06	90°	6680900060	3	4	50	6	2	0,3	90°	6680900300
0,7	3	39	1,4	2	0,07	90°	6680900070	3	3	45	6	2	0,3	90°	6680900303
0,8	3	39	1,6	2	0,08	90°	6680900080	4	5	50	8	2	0,4	90°	6680900400
0,9	3	39	1,8	2	0,09	90°	6680900090	4	4	50	8	2	0,4	90°	6680900404
1	3	39	2	2	0,1	90°	6680900100	5	6	50	10	2	0,5	90°	6680900500
1,1	3	39	2,2	2	0,11	90°	6680900110	5	5	50	10	2	0,5	90°	6680900505
1,2	3	39	2,4	2	0,12	90°	6680900120	6	8	60	12	2	0,6	90°	6680900600
1,3	3	39	2,6	2	0,13	90°	6680900130	6	6	50	12	2	0,6	90°	6680900606
1,4	3	39	2,8	2	0,14	90°	6680900140	8	10	70	16	2	0,8	90°	6680900800
1,5	3	39	3	2	0,15	90°	6680900150	8	8	70	16	2	0,8	90°	6680900808
1,6	3	39	3,2	2	0,16	90°	6680900160	10	12	70	18	2	1	90°	6680901000
1,7	3	39	3,4	2	0,17	90°	6680900170	10	10	70	18	2	1	90°	6680901010
1,8	3	39	3,6	2	0,18	90°	6680900180	12	12	70	20	2	1,2	90°	6680901200
1,9	3	39	3,8	2	0,19	90°	6680900190	16	16	80	26	2	1,6	90°	6680901600
2	3	39	4	2	0,2	90°	6680900200	20	20	100	32	2	2	90°	6680902000
2,1	3	39	4,2	2	0,21	90°	6680900210								

668089 - 90° Lang | long version

ØD h9	Ød2 h6	L	l1	z	T	a	Art. No.	ØD h9	Ød2 h6	L	l1	z	T	a	Art. No.
3	3	80	12	2	0,3	90°	6680890300	10	10	170	36	2	1	90°	6680891000
4	4	100	16	2	0,4	90°	6680890400	12	12	170	40	2	1,2	90°	6680891200
5	5	120	20	2	0,5	90°	6680890500	16	16	200	52	2	1,6	90°	6680891600
6	6	140	24	2	0,6	90°	6680890600	20	20	200	64	2	2	90°	6680892000
8	8	140	32	2	0,8	90°	6680890800								

Multi-V

Multi-V Multifunktionswerkzeuge VHM Carbide Multifunction Tools 90°



- Fräsen, Bohren, Senken, 1 Werkzeug
- Besonders geeignet auf CNC-BAZ
- Weniger Rüstzeit und Bevorratung
- Senkwinkel 90° etc.
- Oberfläche blank

- Milling, drilling, chamfering, 1 tool
- Use on CNC or automatic machines
- Short set up-, work time, easy storage
- Chamfering angle 90° etc.
- Bright finish

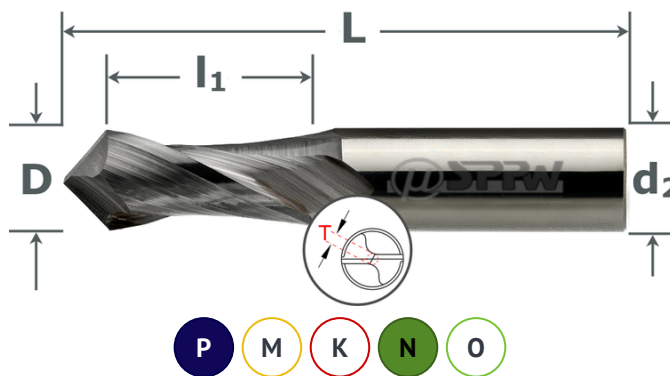

VHM	poliert
90° etc.	z:2
DIN 6535HA	Multi V



668040 - 40°

ØD h9	Ød2 h6	L	l1	z	T	a	Art. No.
0,5	3	39	1	2	0,05	40°	6680400050
1	3	39	2	2	0,1	40°	6680400100
1,5	3	39	3	2	0,15	40°	6680400150
2	3	39	4	2	0,2	40°	6680400200

ØD h9	Ød2 h6	L	l1	z	T	a	Art. No.
3	4	50	6	2	0,3	40°	6680400300
5	6	50	10	2	0,5	40°	6680400500
10	12	70	18	2	1	40°	6680401000
12	12	70	20	2	1,2	40°	6680401200

668088 - 60°

ØD h9	Ød2 h6	L	l1	z	T	a	Art. No.
0,5	3	39	1	2	0,05	60°	6680880050
0,8	3	39	1,6	2	0,08	60°	6680880080
1	3	39	2	2	0,1	60°	6680880100
1,2	3	39	2,4	2	0,12	60°	6680880120
1,5	3	39	3	2	0,15	60°	6680880150
1,8	3	39	3,6	2	0,18	60°	6680880180
2	3	39	4	2	0,2	60°	6680880200
2,5	3	39	5	2	0,25	60°	6680880250
3	4	50	6	2	0,3	60°	6680880300

ØD h9	Ød2 h6	L	l1	z	T	a	Art. No.
4	5	50	8	2	0,4	60°	6680880400
5	6	50	10	2	0,5	60°	6680880500
6	8	60	12	2	0,6	60°	6680880600
8	10	70	16	2	0,8	60°	6680880800
10	12	70	18	2	1	60°	6680881000
12	12	70	20	2	1,2	60°	6680881200
16	16	80	26	2	1,6	60°	6680881600
20	20	105	32	2	2	60°	6680882000

668095 - 100° AVIATION

ØD h9	Ød2 h6	L	l1	z	T	a	Art. No.
6	8	60	12	2	0,6	100°	6680950600
8	10	70	16	2	0,8	100°	6680950800
10	12	70	18	2	1	100°	6680951000

ØD h9	Ød2 h6	L	l1	z	T	a	Art. No.
12	12	70	20	2	1,2	100°	6680951200
16	16	80	26	2	1,6	100°	6680951600



- Fräsen, Bohren, Senken, 1 Werkzeug
- Besonders geeignet auf CNC-BAZ
- Weniger Rüstzeit und Bevorratung
- Senkwinkel 90° etc.
- Oberfläche blank
- Milling, drilling, chamfering, 1 tool
- Use on CNC or automatic machines
- Short set up-, work time, easy storage
- Chamfering angle 90° etc.
- Bright finish

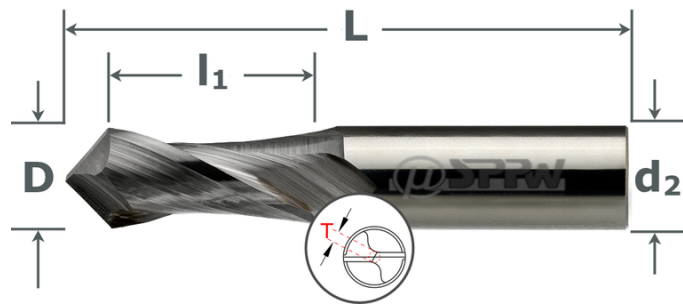

VHM	poliert
90° etc.	z:2
DIN 6535HA	Multi V

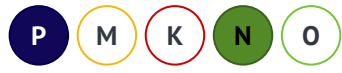

668092 - 120°

ØD h9	Ød2 h6	L	l1	z	T	a	Art. No.	ØD h9	Ød2 h6	L	l1	z	T	a	Art. No.
1	3	39	2	2	0,1	120°	6680920100	6	8	60	12	2	0,6	120°	6680920600
1,5	3	39	3	2	0,15	120°	6680920150	8	10	70	16	2	0,8	120°	6680920800
2	3	39	4	2	0,2	120°	6680920200	10	12	70	18	2	1	120°	6680921000
2,5	3	39	5	2	0,25	120°	6680920250	12	12	70	20	2	1,2	120°	6680921200
3	4	50	6	2	0,3	120°	6680920300	16	16	80	26	2	1,6	120°	6680921600
4	5	50	8	2	0,4	120°	6680920400	20	20	100	32	2	2	120°	6680922000
5	6	50	10	2	0,5	120°	6680920500								

G

— INFO —

Multifunktional ...

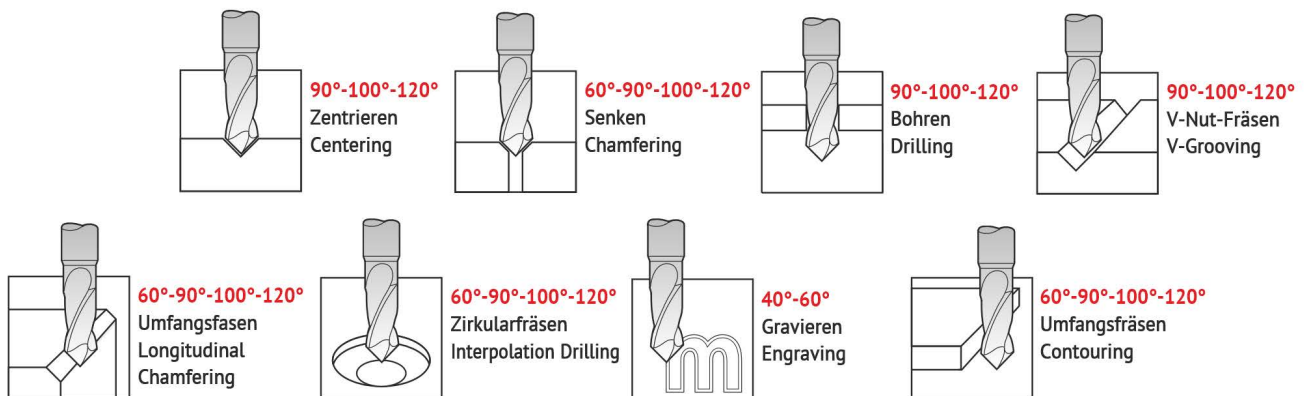

Multi-V

Multi-V Multifunktionswerkzeuge VHM+X.Cut Carbide Multifunction Tools+X.Cut 90°



- Fräsen, Bohren, Senken, ein Werkzeug
- Besonders geeignet auf CNC-BAZ
- Senkt Rüstzeit und Bevorratung
- Senkwinkel 90° etc.
- Oberfläche X.Cut beschichtet

- Milling, drilling, chamfering, 1 tool
- Use on CNC or automatic machines
- Short set up-, work time, easy storage
- Chamfering angle 90° etc.
- With X.Cut coating

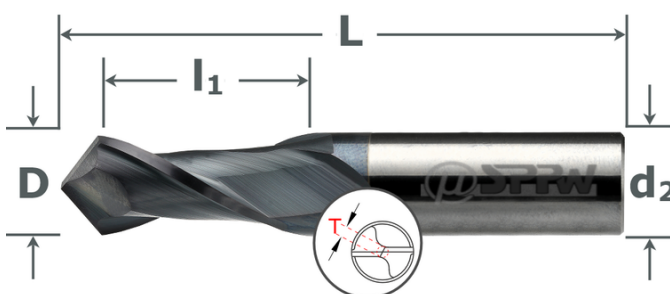

VHM	X Cut
90° etc.	z:2
DIN 6535HA	Multi V



678090 - 90°

ØD h9	Ød2 h6	L	l1	z	T	a	Art. No.
0,1	3	39	0,2	2	0,01	90°	6780900010
0,2	3	39	0,4	2	0,02	90°	6780900020
0,3	3	39	0,6	2	0,03	90°	6780900030
0,4	3	39	0,8	2	0,04	90°	6780900040
0,5	3	39	1	2	0,05	90°	6780900050
0,6	3	39	1,2	2	0,06	90°	6780900060
0,7	3	39	1,4	2	0,07	90°	6780900070
0,8	3	39	1,6	2	0,08	90°	6780900080
0,9	3	39	1,8	2	0,09	90°	6780900090
1	3	39	2	2	0,1	90°	6780900100
1,1	3	39	2,2	2	0,11	90°	6780900110
1,2	3	39	2,4	2	0,12	90°	6780900120
1,3	3	39	2,6	2	0,13	90°	6780900130
1,4	3	39	2,8	2	0,14	90°	6780900140
1,5	3	39	3	2	0,15	90°	6780900150
1,6	3	39	3,2	2	0,16	90°	6780900160
1,7	3	39	3,4	2	0,17	90°	6780900170
1,8	3	39	3,6	2	0,18	90°	6780900180

ØD h9	Ød2 h6	L	l1	z	T	a	Art. No.
1,9	3	39	3,8	2	0,19	90°	6780900190
2	3	39	4	2	0,2	90°	6780900200
2,1	3	39	4,2	2	0,21	90°	6780900210
2,2	3	39	4,4	2	0,22	90°	6780900220
2,3	3	39	4,6	2	0,23	90°	6780900230
2,4	3	39	4,8	2	0,24	90°	6780900240
2,5	3	39	5	2	0,25	90°	6780900250
2,6	3	39	5,2	2	0,26	90°	6780900260
3	4	50	6	2	0,3	90°	6780900300
4	5	50	8	2	0,4	90°	6780900400
5	6	50	10	2	0,5	90°	6780900500
6	8	60	12	2	0,6	90°	6780900600
8	10	70	16	2	0,8	90°	6780900800
10	12	70	18	2	1	90°	6780901000
12	12	70	20	2	1,2	90°	6780901200
16	16	80	26	2	1,6	90°	6780901600
20	20	100	32	2	2	90°	6780902000

678089 - 90° lang | long version

ØD h9	Ød2 h6	L	l1	z	T	a	Art. No.
3	3	80	12	2	0,3	90°	6780890300
4	4	100	16	2	0,4	90°	6780890400
5	5	120	20	2	0,5	90°	6780890500
6	6	140	24	2	0,6	90°	6780890600
8	8	140	32	2	0,8	90°	6780890800

ØD h9	Ød2 h6	L	l1	z	T	a	Art. No.
10	10	170	36	2	1	90°	6780891000
12	12	170	40	2	1,2	90°	6780891200
16	16	200	52	2	1,6	90°	6780891600
20	20	200	64	2	2	90°	6780892000



- Fräsen, Bohren, Senken, ein Werkzeug
- Besonders geeignet auf CNC-BAZ
- Senkt Rüstzeit und Bevorratung
- Senkwinkel 90° etc.
- Oberfläche X.Cut beschichtet
- Milling, drilling, chamfering, 1 tool
- Use on CNC or automatic machines
- Short set up-, work time, easy storage
- Chamfering angle 90° etc.
- With X.Cut coating

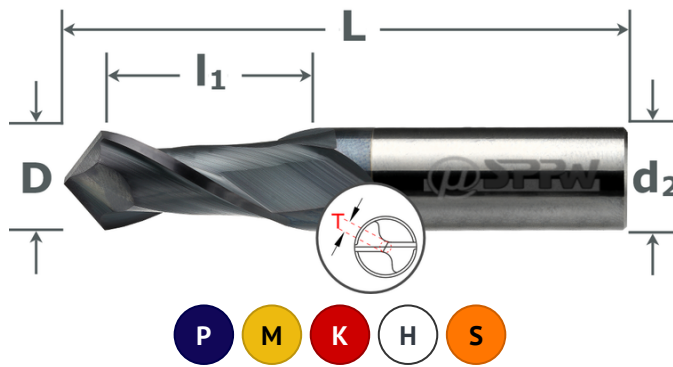

VHM	X Cut
90° etc.	z:2
DIN 6535HA	Multi V

678040 - 40° Gravieren | engraving

ØD h9	Ød2 h6	L	l1	z	T	a	Art. No.
0,5	3	39	1	2	0,05	40°	6780400050
1	3	39	2	2	0,1	40°	6780400100
1,5	3	39	3	2	0,15	40°	6780400150
2	3	39	4	2	0,2	40°	6780400200

ØD h9	Ød2 h6	L	l1	z	T	a	Art. No.
3	4	50	6	2	0,3	40°	6780400300
5	6	50	10	2	0,5	40°	6780400500
10	12	70	18	2	1	40°	6780401000
12	12	70	20	2	1,2	40°	6780401200

G

678088 - 60°

ØD h9	Ød2 h6	L	l1	z	T	a	Art. No.
0,5	3	39	1	2	0,05	60°	6780880050
0,8	3	39	1,6	2	0,08	60°	6780880080
1	3	39	2	2	0,1	60°	6780880100
1,2	3	39	2,4	2	0,12	60°	6780880120
1,5	3	39	3	2	0,15	60°	6780880150
1,8	3	39	3,6	2	0,18	60°	6780880180
2	3	39	4	2	0,2	60°	6780880200
2,5	3	39	5	2	0,25	60°	6780880250
3	4	50	6	2	0,3	60°	6780880300

ØD h9	Ød2 h6	L	l1	z	T	a	Art. No.
4	5	50	8	2	0,4	60°	6780880400
5	6	50	10	2	0,5	60°	6780880500
6	8	60	12	2	0,6	60°	6780880600
8	10	70	16	2	0,8	60°	6780880800
10	12	70	18	2	1	60°	6780881000
12	12	70	20	2	1,2	60°	6780881200
16	16	80	26	2	1,6	60°	6780881600
20	20	105	32	2	2	60°	6780882000

678095 - 100° AVIATION

ØD h9	Ød2 h6	L	l1	z	T	a	Art. No.
6	8	60	12	2	0,6	100°	6780950600
8	10	70	16	2	0,8	100°	6780950800
10	12	70	18	2	1	100°	6780951000

ØD h9	Ød2 h6	L	l1	z	T	a	Art. No.
12	12	70	20	2	1,2	100°	6780951200
16	16	80	26	2	1,6	100°	6780951600

Multi-V

Multi-V Multifunktionswerkzeuge VHM+X.Cut Carbide Multifunction Tools+X.Cut 90°



- Fräsen, Bohren, Senken, ein Werkzeug
- Besonders geeignet auf CNC-BAZ
- Senkt Rüstzeit und Bevorratung
- Senkwinkel 90° etc.
- Oberfläche X.Cut beschichtet
- Milling, drilling, chamfering, 1 tool
- Use on CNC or automatic machines
- Short set up-, work time, easy storage
- Chamfering angle 90° etc.
- With X.Cut coating

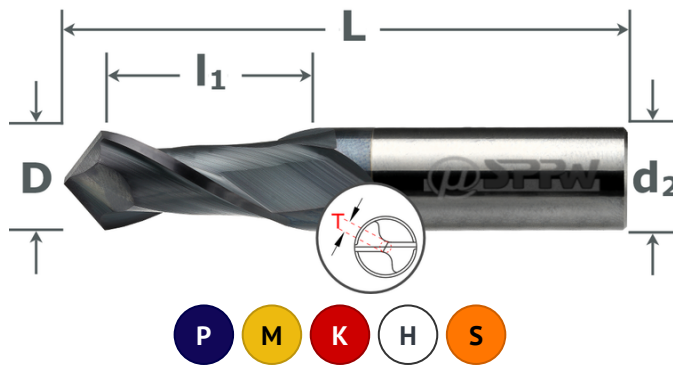

VHM	X Cut
90° etc.	z:2
DIN 6535HA	Multi V

678092 - 120°

ØD h9	Ød2 h6	L	l1	z	T	a	Art. No.
1	3	39	2	2	0,1	120°	6780920100
1,5	3	39	3	2	0,15	120°	6780920150
2	3	39	4	2	0,2	120°	6780920200
2,5	3	39	5	2	0,25	120°	6780920250
3	4	50	6	2	0,3	120°	6780920300
4	5	50	8	2	0,4	120°	6780920400
5	6	50	10	2	0,5	120°	6780920500

ØD h9	Ød2 h6	L	l1	z	T	a	Art. No.
6	8	60	12	2	0,6	120°	6780920600
8	10	70	16	2	0,8	120°	6780920800
10	12	70	18	2	1	120°	6780921000
12	12	70	20	2	1,2	120°	6780921200
16	16	80	26	2	1,6	120°	6780921600
20	20	100	32	2	2	120°	6780922000

— INFO —

1 MULTI-V® = 8 Operationen



157 007

Multifunktionswerkzeuge HSS-E05+X.Cut CombiMag 90°
HSS-E05 Multifunctions Tools+X.Cut CombiMag 90°



- 1 Werkzeug für 5 Bearbeitungen:
- Bohren, Zentrieren und Senken
- Fasen, Kontur-Fasen
- Senkwinkel 90°
- Oberfläche X5.Cut beschichtet

- 1 tool for 5 operations:
- drilling, spotting and sinking
- Chamfering, chamfer-milling
- Chamfering angle 90°
- With X5.Cut coating"

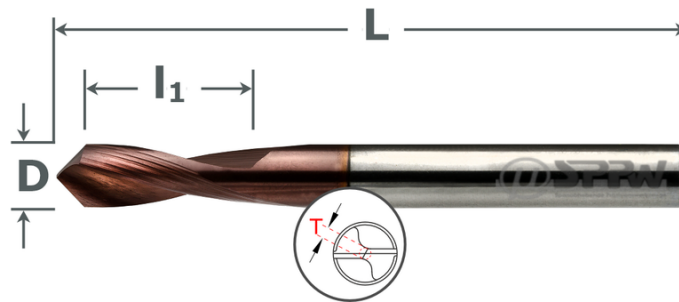

HSS E05	X Cut
90°	z:2
ZYL	Combi Mag



ØD h7	Zoll	L -1	l1 0/+1	T	Art. No.	ØD h7	Zoll	L -1	l1 0/+1	T	Art. No.
3		50	6	0,3	1570070300	8		79	14	0,8	1570070800
3,17	1/8"	50	6	0,3	1570070317	9,52	3/8"	89	16	1	1570070952
4		52	8	0,4	1570070400	10		89	16	1	1570071000
4,76	3/16"	60	9	0,5	1570070476	12		102	18	1,2	1570071200
5		60	10	0,5	1570070500	12,7	1/2"	102	19	1,3	1570071270
6		66	12	0,6	1570070600	14		115	21	1,4	1570071400
6,35	1/4"	66	12	0,6	1570070635	15,87	5/8"	115	24	1,6	1570071587
7,93	5/16"	79	14	0,8	1570070793	16		115	24	1,6	1570071600

— INFO —

COMBI-mag - Das Multifunktions-Tool aus HSS-E

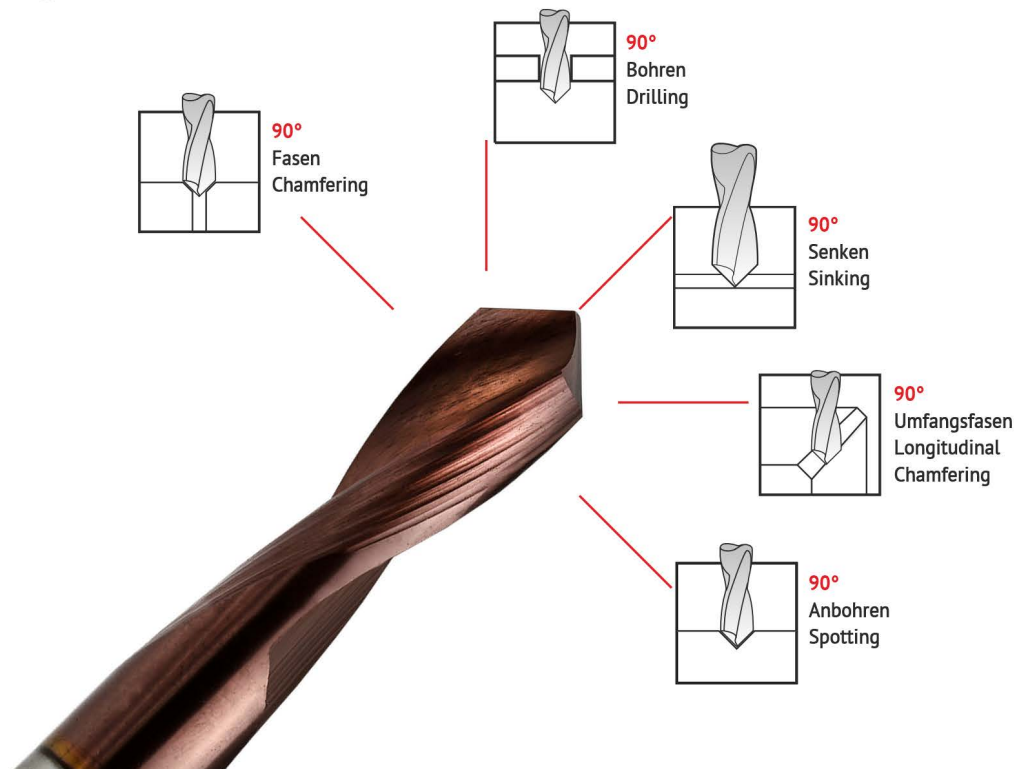

668 480

Mini Vor- und Rückwärtsentgrater VHM Bi-Face 90°
Mini Carbide Forward / Backward Deburrer Bi-Face 90°



- Entgraten, Fasen, Rückwärtsentgraten
- Lange Ausführung
- Beidseitig geschliffener Kopf
- Winkel 90°
- Oberfläche blank
- Front/back deburring
- Long version
- Difficult access
- Chamfering angle 90°
- Bright finish

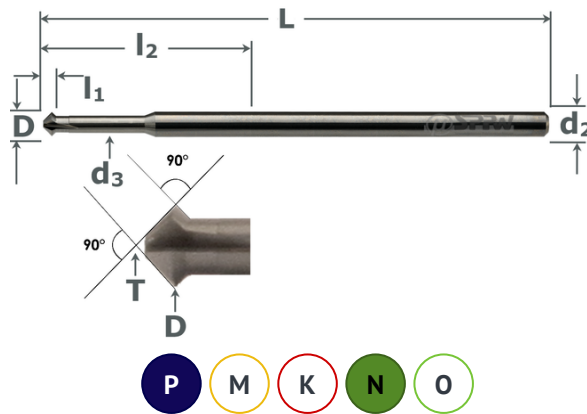

VHM	poliert
90°	z: 1-3
DIN 6535HA	Micro



ØD	Ød2	Ød3	L	l1	l2	z	T	Art. No.	ØD	Ød2	Ød3	L	l1	l2	z	T	Art. No.
	h6	max.	-1		min.		max.			h6	max.	-1		min.		max.	
0,2	3	0,12	39	0,11	0,29	1	0,12	6684800020	1	3	0,7	60	0,5	5	3	0,3	6684800100
0,25	3	0,15	39	0,13	0,37	1	0,15	6684800025	1,5	3	1,1	60	0,73	6	3	0,45	6684800150
0,3	3	0,18	39	0,15	0,45	1	0,18	6684800030	1,8	3	1,4	60	0,75	8	3	0,6	6684800180
0,4	3	0,24	39	0,19	0,61	1	0,24	6684800040	2	3	1,5	60	0,95	8	3	0,6	6684800200
0,5	3	0,3	39	0,23	0,77	1	0,3	6684800050	2,8	3	2,1	60	1,3	10	3	0,9	6684800280
0,6	3	0,36	39	0,27	0,93	3	0,36	6684800060	3	3	2,1	60	1,5	10	3	0,9	6684800300
0,8	3	0,48	39	0,35	1,25	3	0,48	6684800080									

678 480

Mini Vor- und Rückwärtsentgrater VHM+X.Cut Bi-Face 90°
Mini Carbide Forward / Backward Deburrer+X.Cut Bi-Face 90°



- Zum Rückwärts-, Entgraten, Fasen
- Lange Ausführung
- Beidseitig geschliffener Kopf
- Winkel 90°
- Oberfläche X.Cut beschichtet
- Front / back deburring
- Long version
- For difficult access
- Chamfering angle 90°
- With X.Cut coating

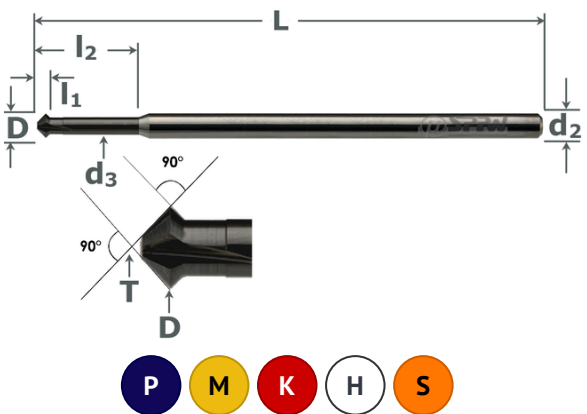

VHM	X Cut
90°	z: 1-3
DIN 6535HA	Micro



ØD	Ød2	Ød3	L	l1	l2	z	T	Art. No.	ØD	Ød2	Ød3	L	l1	l2	z	T	Art. No.
	h6	max.	-1		min.		max.			h6	max.	-1		min.		max.	
0,2	3	0,12	39	0,11	0,29	1	0,12	6784800020	1	3	0,7	60	0,5	5	3	0,3	6784800100
0,25	3	0,15	39	0,13	0,37	1	0,15	6784800025	1,5	3	1,1	60	0,73	6	3	0,45	6784800150
0,3	3	0,18	39	0,15	0,45	1	0,18	6784800030	1,8	3	1,4	60	0,75	8	3	0,6	6784800180
0,4	3	0,24	39	0,19	0,61	1	0,24	6784800040	2	3	1,5	60	0,95	8	3	0,6	6784800200
0,5	3	0,3	39	0,23	0,77	1	0,3	6784800050	2,8	3	2,1	60	1,3	10	3	0,9	6784800280
0,6	3	0,36	39	0,27	0,93	3	0,36	6784800060	3	3	2,1	60	1,5	10	3	0,9	6784800300
0,8	3	0,48	39	0,35	1,25	3	0,48	6784800080									

668 490

Vor- und Rückwärtsentgrater VHM Bi-Face 90°
Carbide Forward / Backward Deburrer Bi-Face 90°



- Zum Rückwärts-, Entgraten, Fasen
- Lange Ausführung
- Beidseitig geschliffener Kopf
- Winkel 90°
- Oberfläche blank
- Front / back deburring
- Long version
- Difficult access
- Chamfering angle 90°
- Bright finish

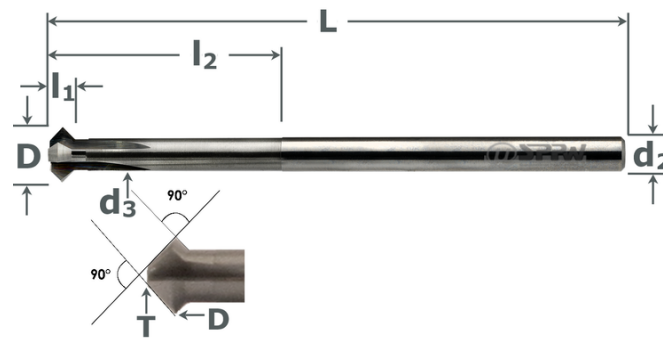

VHM	poliert
90°	z:4
DIN 6535HA	L lang



ØD	Ød2	Ød3	L	l1	l2	z	T	Art. No.
	h6	max.	-1		min.		max.	
2,8	6	2,2	100	1,1	10	4	1,2	6684900280
3	6	2,2	100	1,3	10	4	1,2	6684900300
3,8	6	2,9	100	1,55	12	4	1,6	6684900380
4	6	2,9	100	1,75	12	4	1,6	6684900400
4,8	6	3,4	100	2,1	15	4	2	6684900480
5	6	3,4	100	2,3	15	4	2	6684900500
5,8	6	3,8	100	2,7	18	4	2,4	6684900580
6	6	3,8	100	2,9	18	4	2,4	6684900600

ØD	Ød2	Ød3	L	l1	l2	z	T	Art. No.
	h6	max.	-1		min.		max.	
7,8	6	4,9	100	2,8	34	4	4,9	6684900780
8	6	4,9	100	3,1	34	4	4,9	6684900800
9,8	6	5,9	100	3,8	34	4	5,9	6684900980
10	6	5,9	100	4,1	34	4	5,9	6684901000
11,8	6	5,9	100	5,8	34	4	5,9	6684901180
12	6	5,9	100	6,1	34	4	5,9	6684901200
15,8	10	7,9	100	7,8	34	4	7,9	6684901580
16	10	7,9	100	8,1	34	4	7,9	6684901600

G

678 490

Vor- und Rückwärtsentgrater VHM+X.Cut Bi-Face 90°
Carbide Forward / Backward Deburrer+X.Cut Bi-Face 90°



- Zum Rückwärts-, Entgraten, Fasen
- Lange Ausführung
- Beidseitig geschliffener Kopf
- Winkel 90°
- Oberfläche X.Cut beschichtet
- Front / back deburring
- Long version
- For difficult access
- Chamfering angle 90°
- With X.Cut coating

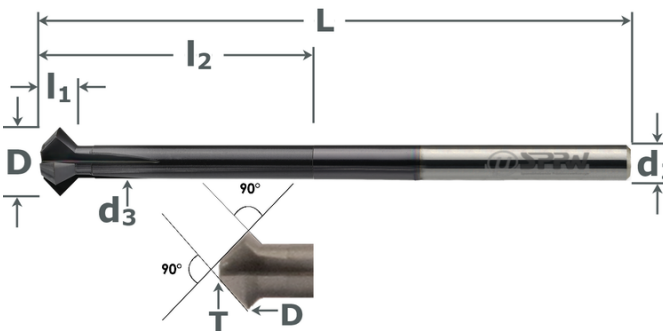

VHM	X Cut
90°	z: 3-4
DIN 6535HA	L lang



ØD	Ød2	Ød3	L	l1	l2	z	T	Art. No.
	h6	max.	-1		min.		max.	
1,8	6	1,2	100	1,2	9	3	spitz	6784900180S
2,8	6	2,2	100	1,1	10	4	1,2	6784900280
2,8	6	2	100	1,8	10	4	spitz	6784900280S
3	6	2,2	100	1,3	10	4	1,2	6784900300
3,8	6	2,9	100	1,55	12	4	1,6	6784900380
4	6	2,9	100	1,75	12	4	1,6	6784900400
4	6	2	100	3	13	4	spitz	6784900400S
4,8	6	3,4	100	2,1	15	4	2	6784900480
5	6	3,4	100	2,3	15	4	2	6784900500
5,8	6	3,8	100	2,7	18	4	2,4	6784900580

ØD	Ød2	Ød3	L	l1	l2	z	T	Art. No.
	h6	max.	-1		min.		max.	
6	6	3,8	100	2,9	18	4	2,4	6784900600
6	6	4	100	4	19	4	spitz	6784900600S
7,8	6	4,9	100	2,8	34	4	4,9	6784900780
8	6	4,9	100	3,1	34	4	4,9	6784900800
9,8	6	5,9	100	3,8	34	4	5,9	6784900980
10	6	5,9	100	4,1	34	4	5,9	6784901000
11,8	6	5,9	100	5,8	34	4	5,9	6784901180
12	6	5,9	100	6,1	34	4	5,9	6784901200
15,8	10	7,9	100	7,8	34	4	7,9	6784901580
16	10	7,9	100	8,1	34	4	7,9	6784901600

668 460

Vor- und Rückwärtsentgrater VHM Bi-Face 60°
Carbide Forward / Backward Deburrer Bi-Face 60°



- Zum Rückwärts-, Entgraten, Fasen
- Lange Ausführung
- Beidseitig geschliffener Kopf
- Winkel 60°
- Oberfläche blank
- Front/back deburring and chamfering
- Long version
- Difficult access
- Chamfering angle 60°
- Bright finish

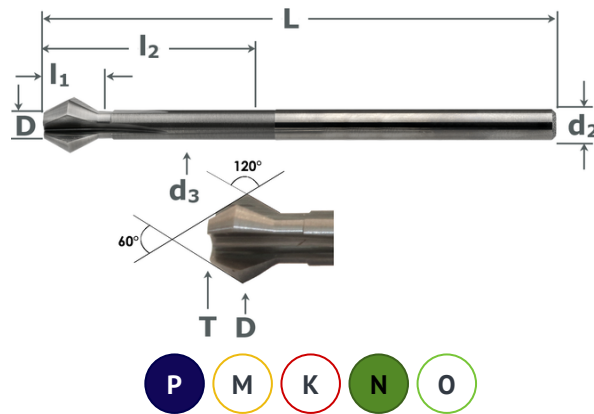

VHM	poliert
60° 120°	z: 3-4
DIN 6535HA	L lang

ØD	Ød2	Ød3	L	l1	l2	z	T	Art. No.	ØD	Ød2	Ød3	L	l1	l2	z	T	Art. No.
	h6	max.	-1		min.		max.			h6	max.	-1		min.		max.	
2	3	1,5	100	1,7	8	3	0,6	6684600200	8	6	4,9	100	5,4	34	4	4,9	6684600800
5	6	3,4	100	2,8	15	4	3,4	6684600500	12	6	5,9	100	10,6	34	4	5,9	6684601200

678 460

Vor- und Rückwärtsentgrater VHM+X.Cut Bi-Face 60°
Carbide Forward / Backward Deburrer+X.Cut Bi-Face 60°



- Zum Rückwärts-, Entgraten, Fasen
- Lange Ausführung
- Beidseitig geschliffener Kopf
- Winkel 60°
- Oberfläche X.Cut beschichtet
- Front/back deburring and chamfering
- Long version
- For difficult access
- Chamfering angle 60°
- With X.Cut coating

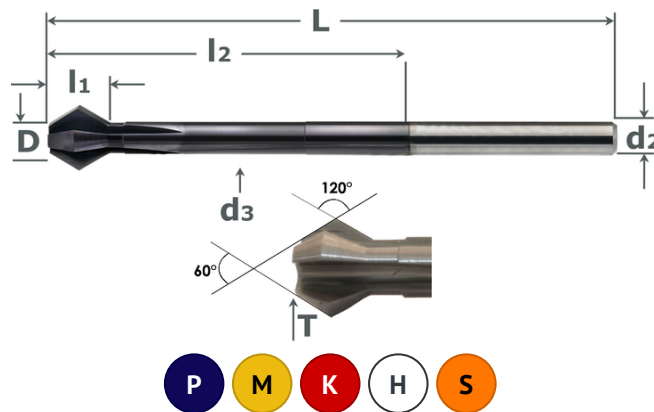

VHM	X Cut
60° 120°	z: 3-4
DIN 6535HA	L lang

ØD	Ød2	Ød3	L	l1	l2	z	T	Art. No.	ØD	Ød2	Ød3	L	l1	l2	z	T	Art. No.
	h6	max.	-1		min.		max.			h6	max.	-1		min.		max.	
2	3	1,5	100	1,7	8	3	0,6	6784600200	8	6	4,9	100	5,4	34	4	4,9	6784600800
5	6	3,4	100	2,8	15	4	3,4	6784600500	12	6	5,9	100	10,6	34	4	5,9	6784601200

— INFO —

Vor-Rückwärts-Entgrater - Mini, 60° & 90° | Forward-Backward-Deburrers

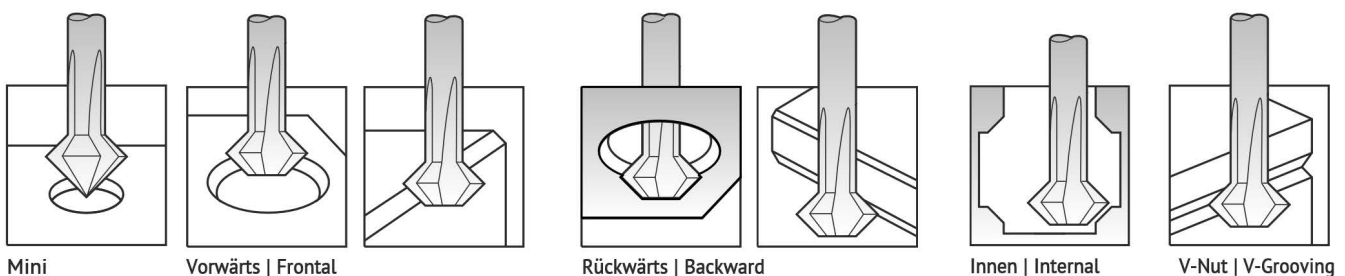



- Nuten für O-Ringe/Sicherungsringe
- Universelle Bearbeitung
- Besonders geeignet auf CNC-BAZ
- Oberfläche blank
- Grooves for O-rings or retaining rings
- Universal machining
- Especially suitable on CNC
- Surface bright

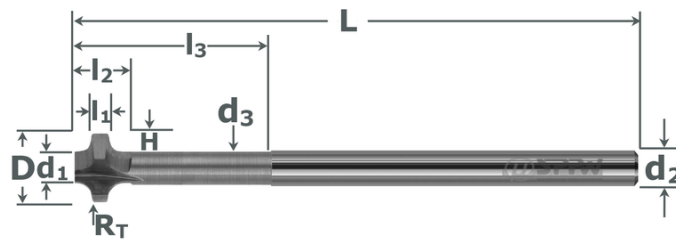

VHM	poliert
z:3	DIN 6535HA
O Ring	

Torus	ØD	H	Ød2 h5	Ød1	Ød3	L	l1	l2	l3	Art. No.
1	4,9	0,85	6	3,19	3,1	75	1,4	1,91	10	6684100490
1,20-1,50	5,9	1,1	6	3,69	3,6	75	1,6	2,13	10	6684100590
1,6	7,6	1,35	8	4,89	4,8	80	2	2,56	12	6684100760
1,78-1,80	7,9	1,5	8	4,89	4,8	80	2,3	2,88	12	6684100790
1,90-2,00	9,3	1,7	10	5,89	5,8	90	2,5	3,1	14	6684100930
2,2	9,9	1,9	10	6,09	6	90	2,8	3,42	14	6684100990
2,40-2,50	11,7	2,1	12	7,49	7,4	100	3,2	3,85	16	6684101170
2,60-2,65	12	2,25	14	7,49	7,4	110	3,3	3,96	18	6684101200
2,70-2,80	13,5	2,35	14	8,79	8,7	110	3,4	4,07	18	6684101350
3	13,9	2,55	14	8,79	8,7	110	3,8	4,49	18	6684101390

G

— INFO —

O-Ring Fräser

Um optimale Dichtigkeit zu erreichen, muss der O-Ring gequetscht werden. Dazu empfehlen wir eine rechteckige Nut mit, da der O-Ring bei der Montage nicht beschädigt werden kann.

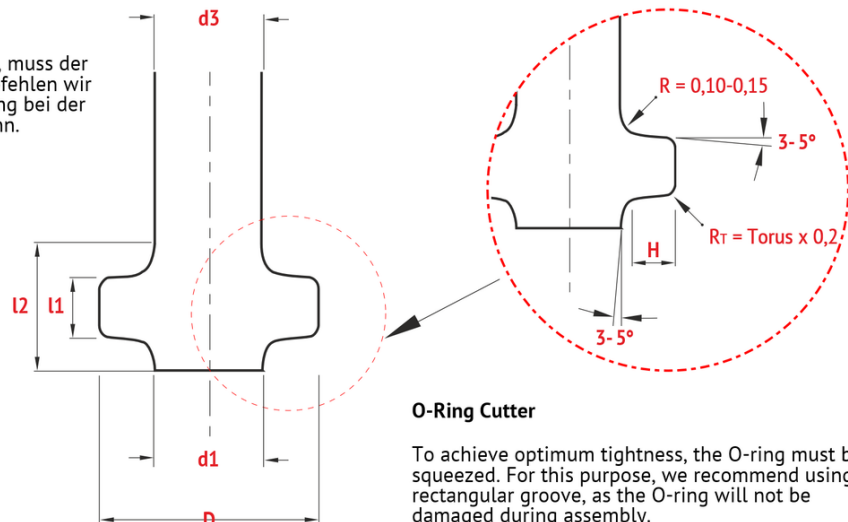
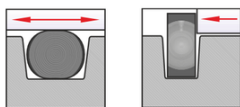

O-Ring Cutter

To achieve optimum tightness, the O-ring must be squeezed. For this purpose, we recommend using a rectangular groove, as the O-ring will not be damaged during assembly.



- Doppelt geschliffen, 1/4-Kreisprofil
- Überlange Ausführung
- Vor/Rück-Entgraten von Radien
- Lange Version für Zugangsprobleme
- Oberfläche X.Cut beschichtet
- 1/4 circle ground on both sides
- Extra long version
- Forward/backward radial deburring
- Difficult access areas
- With X.Cut coating

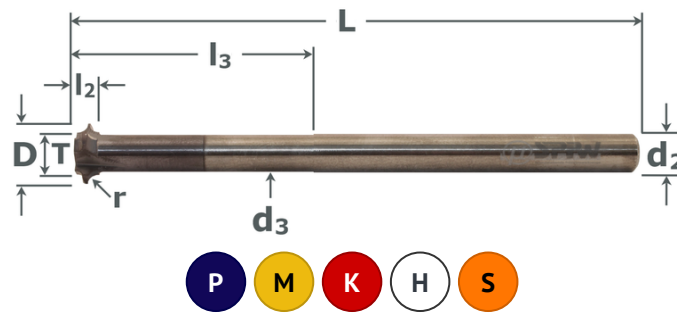

VHM	X Cut
z:3	DIN 6535HA
L lang	Radius

Radius	ØD	Ød2 h5	Ød3 max.	l1	l2	l3	ØT	x	y	Art. No.
0,2	1,9	3	1,25	0,9	1,45	8	0,9	0,87	1,32	6785600203
0,3	2,3	3	1,45	1,2	1,95	9	1,2	1,07	1,82	6785600303
0,4	2,6	3	1,55	1,55	2,5	10	1,55	1,22	2,37	6785600403
0,5	2,90	3	1,65	1,85	3	12	1,85	1,37	2,87	6785600503
0,5	4,9	6	3,65	2,15	3,3	20	2,15	2,37	3,17	6785600506
0,6	5,2	6	3,75	2,14	3,5	25	2,14	2,52	3,37	6785600606
0,8	5,9	6	4,05	2,14	3,9	30	2,14	2,89	3,77	6785600806
1	6,6	8	4,35	2,23	4,3	35	2,23	3,22	4,19	6785601008
1,2	7,4	8	4,75	2,63	5,2	35	2,63	3,62	5,07	6785601208
1,5	8,4	10	5,1	2,73	5,8	35	2,73	4,12	5,77	6785601508
1,8	9,3	10	5,4	2,72	6,4	35	2,72	4,57	6,37	6785601809
2	9,9	10	5,6	2,82	6,8	35	2,82	4,87	6,87	6785602009
2,5	10,9	12	5,6	2,9	7,8	35	2,9	5,37	7,97	6785602510
3	11,9	12	5,6	3	8,8	35	3	5,87	9,07	6785603011



— INFO —

Radius-Vor-/Rückwärts-Entgrater
Radius Forward / Backward Deburrer

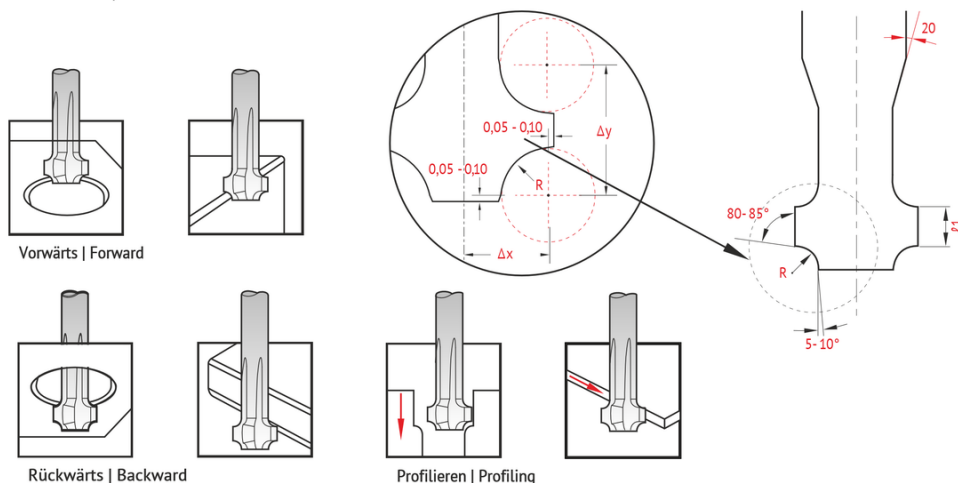

668 550

Micro-1/4-Kreis-Konkavfräser VHM
Carbide Micro Round Corner Cutters



- Für die CNC-Bearbeitung konzipiert
- Konkave Radien
- Werkstücke mit geringer Wandstärke
- Kein Zentrumschnitt
- Oberfläche poliert

- Designed for CNC-machines
- To mill concave radii
- On complex workpieces
- Not center cutting
- Polished finish



VHM	poliert
Radius	z:2
DIN 6535HA	micro

r	Ød1 ±0,1	Ød2 h6	Ød3	L	l1	z	x	Art. No.
0,1	0,5	3	0,8	50	2,5	2	0,35	6685500010
0,15	0,5	3	0,9	50	2,5	2	0,4	6685500015
0,2	0,5	3	1	50	2,5	2	0,45	6685500020
0,25	0,5	3	1,1	50	2,5	2	0,5	6685500025
0,3	0,5	3	1,2	50	2,5	2	0,55	6685500030
0,4	0,5	3	1,4	50	2,5	2	0,65	6685500040
0,5	0,5	3	1,6	50	2,5	2	0,75	6685500050
0,6	0,5	3	1,8	50	3	2	0,85	6685500060
0,7	0,5	3	2	50	3	2	0,95	6685500070
0,75	0,5	3	2,1	50	3	2	1	6685500075
0,8	0,8	3	2,5	50	4	2	1,2	6685500080
0,9	0,8	3	2,7	50	4	2	1,3	6685500090

r	Ød1 ±0,1	Ød2 h6	Ød3	L	l1	z	x	Art. No.
1	0,8	3	2,9	50	4	2	1,4	6685500100
1,25	0,8	4	3,4	50	4	2	1,65	6685500125
1,5	1,5	5	4,6	50	6	2	2,25	6685500150
1,75	1,5	6	5,1	50	6	2	2,5	6685500175
2	1,5	6	5,6	50	8	2	2,75	6685500200
2,25	1,5	8	6,1	50	10	2	3	6685500225
2,5	1,5	8	6,6	50	10	2	3,25	6685500250
3	1,5	8	7,6	50	10	2	3,75	6685500300
4	1,9	10	10	55	2	4,95	6685500400	
5	1,9	12	12	63	2	5,95	6685500500	
6	1,9	14	14	74	2	6,95	6685500600	

G

INFO

Viertelkreis-Konkavfräser
Round Corner Cutter

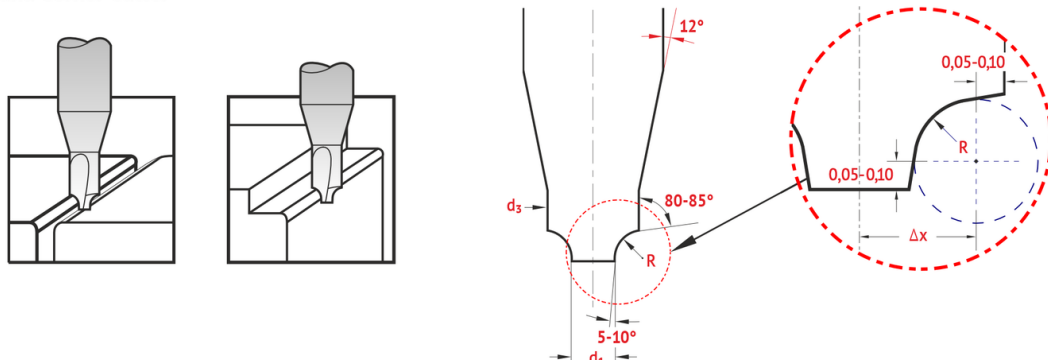



- Für die CNC-Bearbeitung konzipiert
- Konkave Radien
- Werkstücke mit geringer Wandstärke
- Kein Zentrumschnitt
- Oberfläche X.Cut beschichtet

- Designed for CNC-machines
- To mill concave radii
- On complex workpieces
- Not center cutting
- With X.Cut coating



VHM	X Cut
Radius	z:2
DIN 6535HA	micro

r	Ød1 ±0,1	Ød2 h6	Ød3	L	l1	z	x	Art. No.
0,1	0,5	3	0,8	50	2,5	2	0,35	6785500010
0,15	0,5	3	0,9	50	2,5	2	0,4	6785500015
0,2	0,5	3	1	50	2,5	2	0,45	6785500020
0,25	0,5	3	1,1	50	2,5	2	0,5	6785500025
0,3	0,5	3	1,2	50	2,5	2	0,55	6785500030
0,4	0,5	3	1,4	50	2,5	2	0,65	6785500040
0,5	0,5	3	1,6	50	2,5	2	0,75	6785500050
0,6	0,5	3	1,8	50	3	2	0,85	6785500060
0,7	0,5	3	2	50	3	2	0,95	6785500070
0,75	0,5	3	2,1	50	3	2	1	6785500075
0,8	0,8	3	2,5	50	4	2	1,2	6785500080
0,9	0,8	3	2,7	50	4	2	1,3	6785500090

r	Ød1 ±0,1	Ød2 h6	Ød3	L	l1	z	x	Art. No.
1	0,8	3	2,9	50	4	2	1,4	6785500100
1,25	0,8	4	3,4	50	4	2	1,65	6785500125
1,5	1,5	5	4,6	50	6	2	2,25	6785500150
1,75	1,5	6	5,1	50	6	2	2,5	6785500175
2	1,5	6	5,6	50	8	2	2,75	6785500200
2,25	1,5	8	6,1	50	10	2	3	6785500225
2,5	1,5	8	6,6	50	10	2	3,25	6785500250
3	1,5	8	7,6	50	10	2	3,75	6785500300
4	1,9	10	10	55	2	4,95	6785500400	
5	1,9	12	12	63	2	5,95	6785500500	
6	1,9	14	14	74	2	6,95	6785500600	

INFO

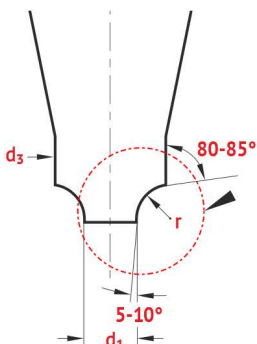

Micro-1/4-Kreis-Konkavfräser

Der Radius (r) ist auf den kleinen Durchmesser (Ød1) ausgerichtet, nicht auf den Schaft (Ød2). Dies ermöglicht die präzise Bearbeitung komplexer Formen, kleinster Bohrungen und Nuten ab einem Durchmesser von 0,5 mm. Δx ist der Abstand des Radius von der Werkzeugachse. Daher lässt sich ein definierter Radius schneller herstellen.

Micro Round Corner Cutters

The radius (r) is positioned in relation to the small diameter (Ød1), so that it is possible to machine compound forms, small slots and holes from diameter 0,5 mm. Δx is the distance between the radius and the axis of the tool. This makes it much quicker to get a defined radius.

678 063**Mini NC-Entgrater VHM+X.Cut 60°
Mini Carbide NC Deburring Tools+X.Cut 60°**

- Mehrschneider, spitze Ausführung 60°
- Ohne umlaufende Fase
- Universelle Anwendung
- Fasen und Entgraten
- X.Cut beschichtet

- Multiflute, pointed 60°
- Without continuous margin
- Universal application
- Chamfering and deburring
- With X.Cut coating

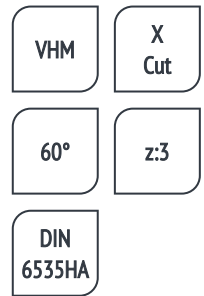
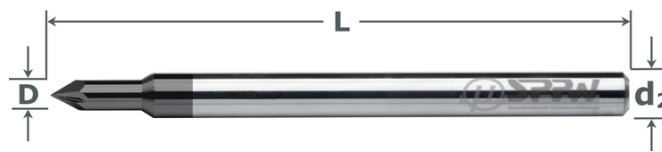

ØD h7	Ød2 h6	L	z	Art. No.	ØD h7	Ød2 h6	L	z	Art. No.
0,5	3	39	3	6780630050	1	3	39	3	6780630100
0,6	3	39	3	6780630060	1,5	3	39	3	6780630150
0,7	3	39	3	6780630070	2	3	39	3	6780630200
0,8	3	39	3	6780630080	2,5	3	39	3	6780630250
0,9	3	39	3	6780630090	3	3	39	3	6780630300

G**678 060****NC-Entgrater VHM+X.Cut 60°
Carbide NC Deburring Tools+X.Cut 60°**

- Mehrschneider, spitze Ausführung 60°
- Ohne umlaufende Fase
- Universelle Anwendung
- Fasen und Entgraten
- Ab Ø 6 mit HB-Schaft
- Oberfläche X.Cut beschichtet

- Multiflute, pointed 60°
- Without continuous margin
- Universal application
- Chamfering and deburring
- From Ø 6 with HB shank
- With X.Cut coating

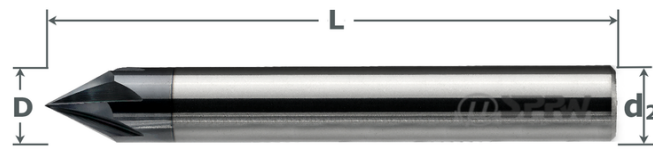

ØD h7	Ød2 h6	L	z	Art. No.	ØD h7	Ød2 h6	L	z	Art. No.
4	4	54	4	6780600400	12	12	83	6	6780601200
6	6	57	4	6780600600	16	16	92	6	6780601600
8	8	63	5	6780600800	20	20	104	6	6780602000
10	10	72	6	6780601000					

678 073

Mini NC-Entgrater VHM+X.Cut 90° Mini Carbide NC Deburring Tools+X.Cut 90°



- Mehrschneider
- Spitze Ausführung 90°
- Ohne umlaufende Fase
- Universelle Anwendung
- Fasen und Entgraten
- Oberfläche X.Cut beschichtet

- Multiflute
- Pointed 90°
- Without continuous margin
- Universal application
- Chamfering and deburring
- With X.Cut coating

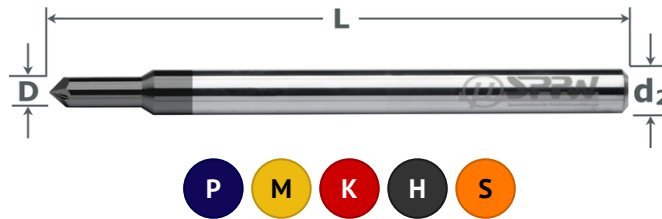

VHM	X Cut
90°	z:3
DIN 6535HA	

ØD z9	Ød2 h6	L	z	l	Art. No.	ØD z9	Ød2 h6	L	z	l	Art. No.
0,5	3	39	3	3	6780730050	1	3	39	3	3	6780730100
0,6	3	39	3	3	6780730060	1,5	3	39	3	4,5	6780730150
0,7	3	39	3	3	6780730070	2	3	39	3	6	6780730200
0,8	3	39	3	3	6780730080	2,5	3	39	3	7,5	6780730250
0,9	3	39	3	3	6780730090	3	3	39	3		6780730300

678 070

NC-Entgrater VHM+X.Cut 90° Carbide NC Deburring Tools+X.Cut 90°



- Mehrschneider, spitz 90°
- Ohne umlaufende Fase
- Universelle Anwendung
- Fasen und Entgraten
- Ab Ø 6 mit HB-Schaft
- Oberfläche X.Cut beschichtet

- Multiflute, pointed 90°
- Without continuous margin
- Universal application
- Chamfering and deburring
- From Ø 6 with HB shank
- With X.Cut coating

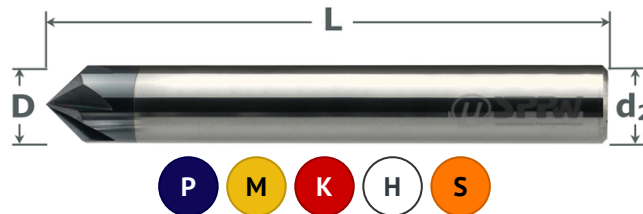

VHM	X Cut
90°	z: 4-6
DIN 6535HA	DIN 6535HB

ØD h7	Ød2 h6	L	z	Art. No.	ØD h7	Ød2 h6	L	z	Art. No.
1	3	38	3	6780700100	8	8	63	5	6780700800
2	3	38	3	6780700200	10	10	72	6	6780701000
3	3	38	3	6780700300	12	12	83	6	6780701200
4	4	54	4	6780700400	16	16	92	6	6780701600
6	6	57	4	6780700600	20	20	104	6	6780702000



- Acryl, Kunststoffe, Holz, NE-Metalle
- Spitzenwinkel 40° etc.
- Graviertiefe 1 mm
- Oberfläche blank

- Acrylic, plastics, wood, NF-metals
- Point angle 40° etc.
- Engraving Depth 1 mm
- Bright finish

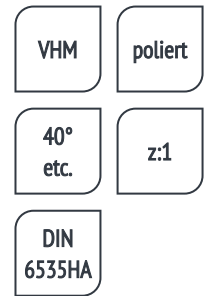
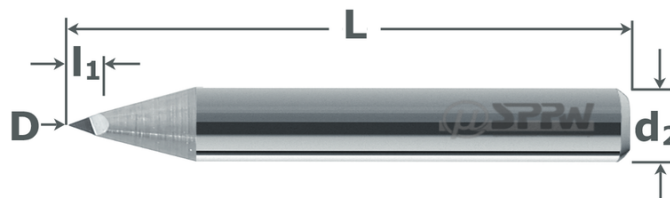
690854 - 40°

ØD ±0,01	L	Ød2 h5	a	Art. No.	ØD ±0,01	L	Ød2 h5	a	Art. No.
0,05	39	3	40°	6908540005	0,09	39	3	40°	6908540009
0,06	39	3	40°	6908540006	0,10	39	3	40°	6908540010
0,07	39	3	40°	6908540007	0,15	39	3	40°	6908540015
0,08	39	3	40°	6908540008	0,20	39	3	40°	6908540020

690856 - 60°

ØD ±0,01	L	Ød2 h5	a	Art. No.	ØD ±0,01	L	Ød2 h5	a	Art. No.
0,05	39	3	60°	6908560005	0,09	39	3	60°	6908560009
0,06	39	3	60°	6908560006	0,10	39	3	60°	6908560010
0,07	39	3	60°	6908560007	0,15	39	3	60°	6908560015
0,08	39	3	60°	6908560008	0,20	39	3	60°	6908560020

690859 - 90°

ØD ±0,01	L	Ød2 h5	a	Art. No.	ØD ±0,01	L	Ød2 h5	a	Art. No.
0,05	39	3	90°	6908590005	0,09	39	3	90°	6908590009
0,06	39	3	90°	6908590006	0,10	39	3	90°	6908590010
0,07	39	3	90°	6908590007	0,15	39	3	90°	6908590015
0,08	39	3	90°	6908590008	0,20	39	3	90°	6908590020

GRAVER

Micro-Gravierfräser VHM Graviertiefe max. 1 mm Carbide Micro-Engraving Tools Engraving Depth 1 mm



- Stahl, Inox, NE-Metalle
- Spitzwinkel 40° etc.
- Graviertiefe 1 mm
- Oberfläche X.Cut beschichtet
- Acrylic, plastics, wood, NF-metals
- Point angle 40° etc.
- Engraving Depth 1 mm
- With X.Cut coating

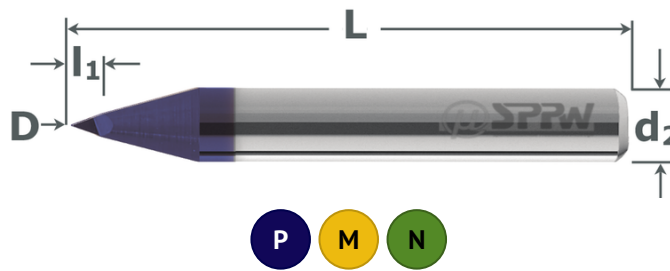

VHM	X Cut
40° etc.	z:1
DIN 6535HA	

690854.X - 40° X.Cut

ØD ±0,01	L	Ød2 h5	a	Art. No.	ØD ±0,01	L	Ød2 h5	a	Art. No.
0,05	39	3	40°	6908540005X	0,09	39	3	40°	6908540009X
0,06	39	3	40°	6908540006X	0,10	39	3	40°	6908540010X
0,07	39	3	40°	6908540007X	0,15	39	3	40°	6908540015X
0,08	39	3	40°	6908540008X	0,20	39	3	40°	6908540020X

690856.X - 60° X.Cut

ØD ±0,01	L	Ød2 h5	a	Art. No.	ØD ±0,01	L	Ød2 h5	a	Art. No.
0,05	39	3	60°	6908560005X	0,09	39	3	60°	6908560009X
0,06	39	3	60°	6908560006X	0,10	39	3	60°	6908560010X
0,07	39	3	60°	6908560007X	0,15	39	3	60°	6908560015X
0,08	39	3	60°	6908560008X	0,20	39	3	60°	6908560020X

690859.X - 90° X.Cut

ØD ±0,01	L	Ød2 h5	a	Art. No.	ØD ±0,01	L	Ød2 h5	a	Art. No.
0,05	39	3	90°	6908590005X	0,09	39	3	90°	6908590009X
0,06	39	3	90°	6908590006X	0,10	39	3	90°	6908590010X
0,07	39	3	90°	6908590007X	0,15	39	3	90°	6908590015X
0,08	39	3	90°	6908590008X	0,20	39	3	90°	6908590020X

INFO

Gravierfräser Engraving Tools

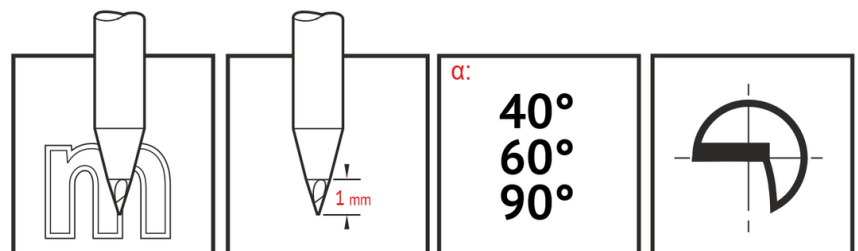
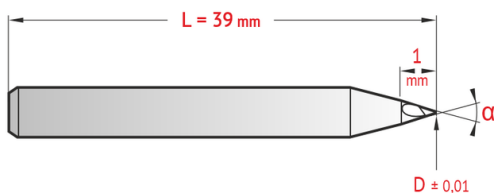



[DE] **Micro Fräsen**
[EN] **Micro Milling**

















passion for precision
[Leidenschaft für Präzision]

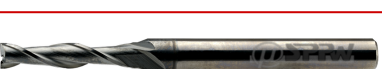

Microfräser

Micro End Mills

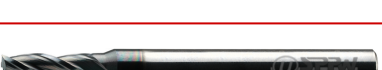



Art.No./Page

●	●	○		●	○		VHM	poliert	micro N	z:2	DIN 6535HA	sharp	Ø 50µ	668 500 Seite H 1	
●	●	○		●	○		VHM	poliert	0,75xØ	micro N	z:2	DIN 6535HA	micro XXS	sharp	668 511 Seite H 2
●	●	○		●	○		VHM	poliert	z:2	DIN 6535HA	micro 1,5xØ	sharp		668 507 Seite H 2	
●	●	○		●	○		VHM	poliert	5xØ	micro N	z:2	DIN 6535HA	micro L	sharp	668 509 Seite H 2
●	●	○		●	○		VHM	poliert	z:2	DIN 6535HA	micro 8xØ	sharp		668 510 Seite H 3	
●	●	●	○	○	○		VHM	X Cut	micro N	z:2	DIN 6535HA	sharp		678 500 Seite H 4	
●	●	●	○	○	○		VHM	X Cut	0,75xØ	z:2	DIN 6535HA	micro XS	sharp	678 511 Seite H 5	
●	●	●	○	○	○		VHM	X Cut	z:2	DIN 6535HA	micro 1,5xØ	sharp		678 507 Seite H 5	
●	●	●	○	○	○		VHM	X Cut	5xØ	z:2	DIN 6535HA	micro L	sharp	678 509 Seite H 5	
●	●	●	○	○	○		VHM	X Cut	z:2	DIN 6535HA	micro 8xØ	sharp		678 510 Seite H 6	
●	●	○		●	○		VHM	poliert	micro N	z:3	DIN 6535HA	sharp		668 533 Seite H 7	
●	●	○		●	○		VHM	poliert	micro N	z:3	DIN 6535HA	micro XS	sharp	668 537 Seite H 7	
●	●	●	○	○	○		VHM	X Cut	micro N	z:3	DIN 6535HA	sharp		678 533 Seite H 8	
●	●	●	○	○	○		VHM	X Cut	z:3	DIN 6535HA	micro XS	sharp		678 537 Seite H 8	
●	●	○	○	○	○		VHM	X Cut	3xØ	z: 2-3	DIN 6535HA	micro 2-3xØ	Fase ch:45°	678 530 Seite H 9	

Micro-Formenbaufräser

Micro End Mills for Moldmaking

Art.No./Page

●	●	○		●	○		VHM	poliert	z:2	DIN 6535HA	micro NECK	sharp		668 507 F Seite H 3
●	●	●	○	○	○		VHM	X Cut	z:2	DIN 6535HA	micro NECK	sharp		678 507 F Seite H 6
○	●	●	●	○	○		VHM	X Cut	micro H	z:2	DIN 6535HA	Hals neck	Torus R=0,002	752 951 Seite H 10
○	●	●	●	○	○		VHM	X Cut	micro H	z:2	DIN 6535HA	Hals neck	Radius ±0,002	752 952 Seite H 12

Microfräser VHM - Carbide Micro End Mills

											VHM	Z Cut	micro W	z:2	DIN 6535HA	Hals neck	sharp	752 853 Seite H 14
											VHM	Z Cut	micro W	z:2	DIN 6535HA	Hals neck	ER Torus	752 854 Seite H 14
											VHM	Z Cut	micro W	z:2	DIN 6535HA	Hals neck	Radius	752 855 Seite H 15
											VHM	X Cut	5xØ	z:2	DIN 6535HA	micro NECK	220° Radius	678 522 Seite H 15
											VHM	poliert	z:2	DIN 6535HA	micro NECK	Radius	668 527 F Seite H 17	
											VHM	X Cut	micro NECK	z:2	DIN 6535HA	Radius	678 527 F Seite H 19	

Micro-Radiusfräser

Micro Radius End Mills

Art.No./Page

											VHM	poliert	z:2	DIN 6535HA	micro 2-3xØ	Radius	668 529 Seite H 16
											VHM	poliert	z:2	DIN 6535HA	micro 0,75xØ	Radius	668 521 Seite H 16
											VHM	poliert	z:2	DIN 6535HA	micro 1,5xØ	Radius	668 527 Seite H 17
											VHM	X Cut	z:2	DIN 6535HA	micro 2-3xØ	Radius	678 529 Seite H 18
											VHM	X Cut	z:2	DIN 6535HA	micro 0,75xØ	Radius	678 521 Seite H 18
											VHM	X Cut	z:2	DIN 6535HA	micro 1,5xØ	Radius	678 527 Seite H 19

Microfräser für CFK/GFK/Grafit

Micro End Mills for FRP/Graphite

Art.No./Page

											VHM	DIA Graph	micro N	z:2	DIN 6535HA	sharp	698 500 Seite H 20	
											VHM	DIA Graph	1,5Ø	z:2	DIN 6535HA	micro XS	sharp	698 507 Seite H 20
											VHM	DIA Graph	5xØ	z:2	DIN 6535HA	micro L	sharp	698 509 Seite H 20
											VHM	DIA Graph	z:2	DIN 6535HA	micro 8xØ	sharp	698 510 Seite H 21	
											VHM	DIA Graph	z:2	DIN 6535HA	Hals neck	sharp	698 507 F Seite H 21	
											VHM	DIA Graph	z:2	DIN 6535HA	micro 2-3xØ	Radius	698 529 Seite H 22	
											VHM	DIA Graph	z:2	DIN 6535HA	Hals neck	Radius	698 527 F Seite H 22	



- Für die allgemeine Anwendung
- Kurze, stabile Ausführung
- Verstärkter Zylinderschaft Form HA
- Zentrumschnitt 1 Schneide über Mitte
- Oberfläche poliert
- For all applications
- Short series with high rigidity
- Reinforced cylindrical shank form HA
- Center cutting
- Polished finish

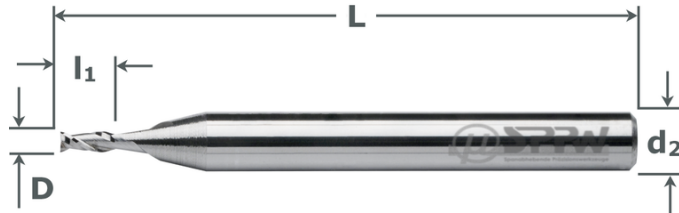

VHM	poliert
micro N	z:2
DIN 6535HA	sharp
Ø 50µ	

668500 - 2-3xØ

ØD h7	Ød2 h5	L	l1	z	Art. No.
0,05	3	39	0,1	2	6685000005
0,06	3	39	0,12	2	6685000006
0,08	3	39	0,16	2	6685000008
0,1	3	39	0,2	2	6685000010
0,12	3	39	0,24	2	6685000012
0,15	3	39	0,3	2	6685000015
0,2	3	39	0,5	2	6685000020
0,25	3	39	0,5	2	6685000025
0,3	3	39	0,8	2	6685000030
0,35	3	39	0,8	2	6685000035
0,4	3	39	1	2	6685000040
0,45	3	39	1	2	6685000045
0,5	3	39	1,5	2	6685000050
0,55	3	39	1,5	2	6685000055
0,6	3	39	1,5	2	6685000060
0,65	3	39	1,5	2	6685000065
0,7	3	39	2	2	6685000070
0,75	3	39	2	2	6685000075
0,8	3	39	2	2	6685000080
0,85	3	39	2	2	6685000085
0,9	3	39	2,5	2	6685000090
0,95	3	39	2,5	2	6685000095
1	3	39	3	2	6685000100
1,05	3	39	3	2	6685000105
1,1	3	39	3	2	6685000110
1,15	3	39	3	2	6685000115
1,2	3	39	4	2	6685000120
1,25	3	39	4	2	6685000125
1,3	3	39	4	2	6685000130
1,4	3	39	4	2	6685000140
1,45	3	39	4	2	6685000145
1,5	3	39	4	2	6685000150
1,55	3	39	5	2	6685000155
1,6-1,7	3	39	5	2	668500xxxx

ØD h7	Ød2 h5	L	l1	z	Art. No.
1,75	3	39	5	2	6685000175
1,8-1,9	3	39	5	2	668500xxxx
2	3	39	5	2	6685000200
2,05	3	39	6	2	6685000205
2,1-2,2	3	39	6	2	668500xxxx
2,25	3	39	6	2	6685000225
2,3-2,4	3	39	6	2	668500xxxx
2,5	3	39	7	2	6685000250
2,6-2,7	3	39	7	2	668500xxxx
2,75	3	39	7	2	6685000275
2,8-2,9	3	39	7	2	668500xxxx
3	4	44	10	2	6685000300
3,1-3,9	4	44	10	2	668500xxxx
4	5	52	12	2	6685000400
4,1-4,9	5	52	12	2	668500xxxx
5	6	52	14	2	6685000500
5,1-5,9	6	52	14	2	668500xxxx
6	6	52	16	2	6685000600
6,1-6,9	8	63	16	2	668500xxxx
7	8	63	18	2	6685000700
7,1-7,9	8	63	18	2	668500xxxx
8	8	63	20	2	6685000800
8,1-8,9	10	72	22	2	668500xxxx
9	10	72	22	2	6685000900
9,1-9,9	10	72	22	2	668500xxxx
10	10	72	26	2	6685001000
10,1-10,9	12	83	26	2	668500xxxx
11	12	83	28	2	6685001100
11,1-11,9	12	83	28	2	668500xxxx
12	12	83	30	2	6685001200
12,1-12,9	14	83	30	2	668500xxxx
13	14	83	32	2	6685001300
13,1-13,9	14	83	32	2	668500xxxx
14	14	83	35	2	6685001400



- Für die allgemeine Anwendung
- Kurze, stabile Ausführung
- Verstärkter Zylinderschaft Form HA
- Zentrumschnitt 1 Schneide über Mitte
- Oberfläche poliert
- For all applications
- Short series with high rigidity
- Reinforced cylindrical shank form HA
- Center cutting
- Polished finish

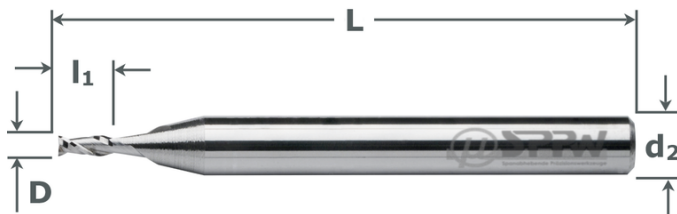

VHM	poliert
micro N	z:2
DIN 6535HA	sharp
Ø 50µ	

668511 - 0,75xØ

ØD h7	Ød2 h5	L	l1	Art. No.
0,4	3	39	0,3	6685110040
0,5	3	39	0,37	6685110050
0,6	3	39	0,45	6685110060

ØD h7	Ød2 h5	L	l1	Art. No.
0,7	3	39	0,53	6685110070
0,8	3	39	0,6	6685110080
1	3	39	0,75	6685110100

668507 - 1,5xØ

ØD h7	Ød2 h5	L	l1	z	Art. No.
0,1	3	39	0,1	2	6685070010
0,15	3	39	0,2	2	6685070015
0,2	3	39	0,3	2	6685070020
0,25	3	39	0,35	2	6685070025
0,3	3	39	0,45	2	6685070030
0,4	3	39	0,6	2	6685070040
0,5	3	39	0,75	2	6685070050
0,6	3	39	0,9	2	6685070060
0,7	3	39	1,05	2	6685070070
0,8	3	39	1,2	2	6685070080
0,9	3	39	1,35	2	6685070090

ØD h7	Ød2 h5	L	l1	z	Art. No.
1	3	39	1,5	2	6685070100
1,1	3	39	1,65	2	6685070110
1,2	3	39	1,8	2	6685070120
1,3	3	39	1,95	2	6685070130
1,4	3	39	2,1	2	6685070140
1,5	3	39	2,25	2	6685070150
1,6	3	39	2,4	2	6685070160
1,7	3	39	2,55	2	6685070170
1,8	3	39	2,7	2	6685070180
1,9	3	39	2,85	2	6685070190
2	3	39	3	2	6685070200

668509 - 5xØ

ØD h7	Ød2 h5	L	l1	Art. No.
0,3	3	39	1,5	6685090030
0,4	3	39	2	6685090040
0,5	3	39	2,5	6685090050
0,6	3	39	3	6685090060
0,7	3	39	3,5	6685090070
0,8	3	39	4	6685090080
0,9	3	39	4,5	6685090090
1	3	39	5	6685090100
1,1	3	39	5,5	6685090110
1,2	3	39	6	6685090120

ØD h7	Ød2 h5	L	l1	Art. No.
1,3	3	39	6,5	6685090130
1,4	3	39	7	6685090140
1,5	3	39	7,5	6685090150
1,6	3	39	8	6685090160
1,7	3	39	8,5	6685090170
1,8	3	39	9	6685090180
1,9	3	39	9,5	6685090190
2	3	39	10	6685090200
2,5	3	45	12,5	6685090250
3	4	46	15	6685090300



668 510

Micro-Bohrnutenfräser VHM Überlang 8xØ
Carbide Micro End Mills Extra Long Series 8xØ



- Für die allgemeine Anwendung
- Überlang: Schneidenlänge 8xØ
- Verstärkter Zylinderschaft Form HA
- Zentrumschnitt 1 Schneide über Mitte
- Oberfläche poliert
- For all applications
- Extra-long: cutting length 8xØ
- Reinforced cylindrical shank form HA
- Center cutting
- Polished finish

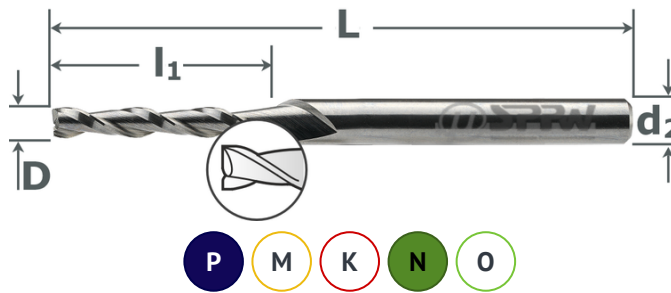

VHM	poliert
z:2	DIN 6535HA
micro 8xØ	sharp

ØD h7	Ød2 h5	L	l1	Art. No.
0,3	3	39	2,4	6685100030
0,4	3	39	3,2	6685100040
0,5	3	39	4	6685100050
0,6	3	39	4,8	6685100060
0,7	3	39	5,6	6685100070
0,8	3	39	6,4	6685100080
0,9	3	39	7,2	6685100090
1	3	39	8	6685100100
1,1	3	39	8,8	6685100110
1,2	3	39	9,6	6685100120
1,3	4	44	10,4	6685100130
1,4	4	44	11,2	6685100140

ØD h7	Ød2 h5	L	l1	Art. No.
1,5	4	44	12	6685100150
1,6	4	44	12,8	6685100160
1,7	4	44	13,6	6685100170
1,8	4	44	14,4	6685100180
1,9	4	44	15,2	6685100190
2	4	44	16	6685100200
2,5	5	60	20	6685100250
3	5	60	24	6685100300
4	6	75	32	6685100400
5	6	75	40	6685100500
6	8	80	48	6685100600

H

668 507 F

Micro-Bohrnutenfräser VHM mit Freistellung
Carbide Micro End Mills with Long Reach



- Anwendung im Kleinstformenbau
- Mit Freistellung / Hals
- Zentrumschnitt 1 Schneide über Mitte
- Oberfläche poliert
- For micro toolmaking application
- Reduced diameter after cutting edge
- Center cutting
- Polished finish

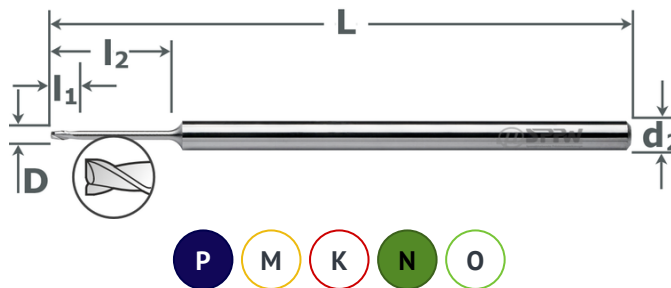

VHM	poliert
z:2	DIN 6535HA
micro NECK	sharp

ØD -0.01	Ød2 h5	L	l1	l2	z	Art. No.
0,4	3	39	0,4	2	2	6685070042
0,5	3	39	0,55	2	2	6685070052
0,5	3	39	0,55	4	2	6685070054
0,5	3	60	0,55	6	2	6685070056
0,6	3	39	0,7	4	2	6685070064
0,7	3	39	0,85	4	2	6685070074
0,8	3	39	1	4	2	6685070084
0,8	3	39	1	6	2	6685070086
0,8	3	60	1	9	2	6685070089
0,9	3	39	1,15	6	2	6685070096
1	3	60	1,3	12	2	6685070101
1	3	39	1,3	4	2	6685070104
1	3	39	1,3	6	2	6685070106
1	3	39	1,3	9	2	6685070109

ØD -0.01	Ød2 h5	L	l1	l2	z	Art. No.
1,2	3	39	1,6	6	2	6685070126
1,2	3	39	1,6	9	2	6685070129
1,4	3	39	1,9	6	2	6685070146
1,4	3	39	1,9	9	2	6685070149
1,5	3	60	2,05	12	2	6685070151
1,5	3	39	2,05	6	2	6685070156
1,5	3	39	2,05	9	2	6685070159
1,8	3	39	2,5	12	2	6685070181
1,8	3	39	2,5	9	2	6685070189
2	3	39	2,8	9	2	6685070209
2	3	39	2,8	12	2	6685070212
2	3	60	2,8	15	2	6685070215
2,5	3	60	3,55	15	2	6685070251

H 3



- Für die allgemeine Anwendung
- Kurze, stabile Ausführung
- Verstärkter Zylinderschaft Form HA
- Zentrumschnitt 1 Schneide über Mitte
- Oberfläche X.Cut beschichtet

- For all applications
- Short series with high rigidity
- Reinforced cylindrical shank form HA
- Center cutting
- With X.Cut coating

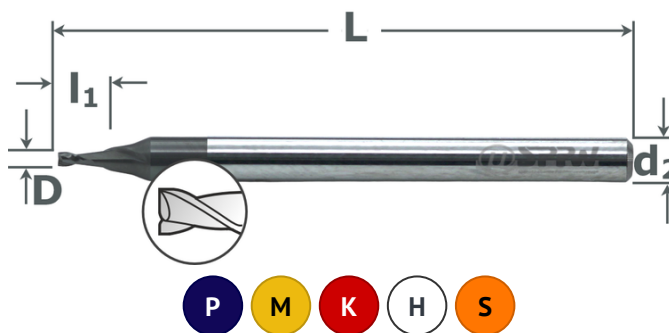

VHM	X Cut
micro N	z:2
DIN 6535HA	sharp

678500 - 2-3xØ

ØD h7	Ød2 h5	L	l1	z	Art. No.
0,1	3	39	0,2	2	6785000010
0,12	3	39	0,24	2	6785000012
0,15	3	39	0,3	2	6785000015
0,2	3	39	0,5	2	6785000020
0,25	3	39	0,5	2	6785000025
0,3	3	39	0,8	2	6785000030
0,35	3	39	0,8	2	6785000035
0,4	3	39	1	2	6785000040
0,45	3	39	1	2	6785000045
0,5	3	39	1,5	2	6785000050
0,55	3	39	1,5	2	6785000055
0,6	3	39	1,5	2	6785000060
0,65	3	39	1,5	2	6785000065
0,7	3	39	2	2	6785000070
0,75	3	39	2	2	6785000075
0,8	3	39	2	2	6785000080
0,85	3	39	2	2	6785000085
0,9	3	39	2,5	2	6785000090
0,95	3	39	2,5	2	6785000095
1	3	39	3	2	6785000100
1,05	3	39	3	2	6785000105
1,1	3	39	3	2	6785000110
1,15	3	39	3	2	6785000115
1,2	3	39	4	2	6785000120
1,25	3	39	4	2	6785000125
1,3	3	39	4	2	6785000130
1,4	3	39	4	2	6785000140
1,45	3	39	4	2	6785000145
1,5	3	39	4	2	6785000150
1,55	3	39	5	2	6785000155
1,6-1,7	3	39	5	2	678500xxxx
1,75	3	39	5	2	6785000175

ØD h7	Ød2 h5	L	l1	z	Art. No.
1,8-1,9	3	39	5	2	678500xxxx
2	3	39	5	2	6785000200
2,05	3	39	6	2	6785000205
2,1-2,2	3	39	6	2	678500xxxx
2,25	3	39	6	2	6785000225
2,3-2,4	3	39	6	2	678500xxxx
2,5	3	39	7	2	6785000250
2,6	3	39	7	2	6785000260
2,6-2,9	3	39	7	2	678500xxxx
3	4	44	10	2	6785000300
3,1-3,9	4	44	10	2	678500xxxx
4	5	52	12	2	6785000400
4,1-4,9	5	52	12	2	678500xxxx
5	6	52	14	2	6785000500
5,1-5,9	6	52	14	2	678500xxxx
6	6	52	16	2	6785000600
6,1-6,9	8	63	16	2	678500xxxx
7	8	63	18	2	6785000700
7,1-7,9	8	63	18	2	678500xxxx
8	8	63	20	2	6785000800
8,1-8,9	10	72	22	2	678500xxxx
9	10	72	22	2	6785000900
9,1-9,9	10	72	22	2	678500xxxx
10	10	72	26	2	6785001000
10,1-10,9	12	83	26	2	678500xxxx
11	12	83	28	2	6785001100
11,1-11,9	12	83	28	2	678500xxxx
12	12	83	30	2	6785001200
12,1-12,9	14	83	30	2	678500xxxx
13	14	83	32	2	6785001300
13,1-13,9	14	83	32	2	678500xxxx
14	14	83	35	2	6785001400





- Für die allgemeine Anwendung
- Kurze, stabile Ausführung
- Verstärkter Zylinderschaft Form HA
- Zentrumschnitt 1 Schneide über Mitte
- Oberfläche X.Cut beschichtet
- For all applications
- Short series with high rigidity
- Reinforced cylindrical shank form HA
- Center cutting
- With X.Cut coating

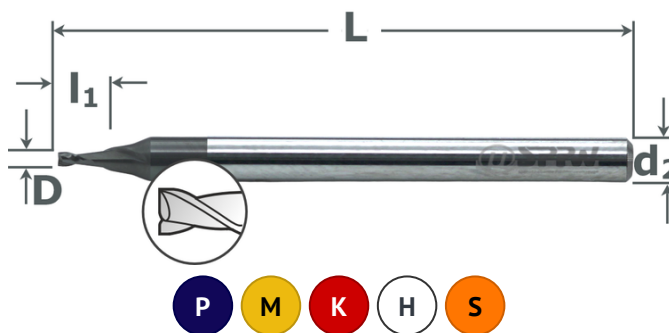

VHM	X Cut
micro N	z:2
DIN 6535HA	sharp

678511 - 0,75xØ

ØD h7	Ød2 h5	L	l1	Art. No.
0,4	3	39	0,3	6785110040
0,5	3	39	0,37	6785110050
0,6	3	39	0,45	6785110060

ØD h7	Ød2 h5	L	l1	Art. No.
0,7	3	39	0,53	6785110070
0,8	3	39	0,6	6785110080
1	3	39	0,75	6785110100

678507 - 1,5xØ

ØD h7	Ød2 h5	L	l1	z	Art. No.
0,1	3	39	0,1	2	6785070010
0,15	3	39	0,2	2	6785070015
0,2	3	39	0,3	2	6785070020
0,25	3	39	0,35	2	6785070025
0,3	3	39	0,45	2	6785070030
0,4	3	39	0,6	2	6785070040
0,5	3	39	0,75	2	6785070050
0,6	3	39	0,9	2	6785070060
0,7	3	39	1,05	2	6785070070
0,8	3	39	1,2	2	6785070080
0,9	3	39	1,35	2	6785070090

ØD h7	Ød2 h5	L	l1	z	Art. No.
1	3	39	1,5	2	6785070100
1,1	3	39	1,65	2	6785070110
1,2	3	39	1,8	2	6785070120
1,3	3	39	1,95	2	6785070130
1,4	3	39	2,1	2	6785070140
1,5	3	39	2,25	2	6785070150
1,6	3	39	2,4	2	6785070160
1,7	3	39	2,55	2	6785070170
1,8	3	39	2,7	2	6785070180
1,9	3	39	2,85	2	6785070190
2	3	39	3	2	6785070200

678509 - 5xØ

ØD h7	Ød2 h5	L	l1	Art. No.
0,3	3	39	1,5	6785090030
0,4	3	39	2	6785090040
0,5	3	39	2,5	6785090050
0,6	3	39	3	6785090060
0,7	3	39	3,5	6785090070
0,8	3	39	4	6785090080
0,9	3	39	4,5	6785090090
1	3	39	5	6785090100
1,1	3	39	5,5	6785090110
1,2	3	39	6	6785090120

ØD h7	Ød2 h5	L	l1	Art. No.
1,3	3	39	6,5	6785090130
1,4	3	39	7	6785090140
1,5	3	39	7,5	6785090150
1,6	3	39	8	6785090160
1,7	3	39	8,5	6785090170
1,8	3	39	9	6785090180
1,9	3	39	9,5	6785090190
2	3	39	10	6785090200
2,5	3	45	12,5	6785090250
3	4	46	15	6785090300

678 510

Micro-Bohrnutenfräser VHM+X.Cut Überlang 8xØ
Carbide Micro End Mills+X.Cut Extra Long Series 8xØ



- Für die allgemeine Anwendung
- Überlang: Schneidlänge 8xØ
- Verstärkter Zylinderschaft Form HA
- Zentrumschnitt 1 Schneide über Mitte
- Oberfläche X.Cut beschichtet
- For all applications
- Extra-long: cutting length 8xØ
- Reinforced cylindrical shank form HA
- Center cutting
- With X.Cut coating

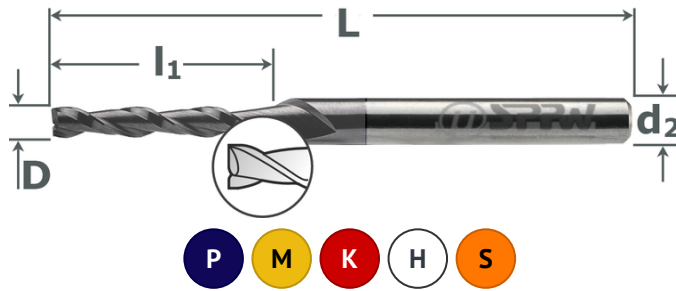

VHM	X Cut
z:2	DIN 6535HA
micro 8xØ	sharp

ØD h7	Ød2 h5	L	l1	Art. No.
0,3	3	39	2,4	6785100030
0,4	3	39	3,2	6785100040
0,5	3	39	4	6785100050
0,6	3	39	4,8	6785100060
0,7	3	39	5,6	6785100070
0,8	3	39	6,4	6785100080
0,9	3	39	7,2	6785100090
1	3	39	8	6785100100
1,1	3	39	8,8	6785100110
1,2	3	39	9,6	6785100120
1,3	4	44	10,4	6785100130
1,4	4	44	11,2	6785100140

ØD h7	Ød2 h5	L	l1	Art. No.
1,5	4	44	12	6785100150
1,6	4	44	12,8	6785100160
1,7	4	44	13,6	6785100170
1,8	4	44	14,4	6785100180
1,9	4	44	15,2	6785100190
2	4	44	16	6785100200
2,5	5	60	20	6785100250
3	5	60	24	6785100300
4	6	75	32	6785100400
5	6	75	40	6785100500
6	8	80	48	6785100600

678 507 F

Micro-Bohrnutenfräser VHM+X.Cut mit Freistellung
Carbide Micro End Mills+X.Cut with Long Reach



- Anwendung im Kleinstformenbau
- Mit Freistellung / Hals
- Zentrumschnitt 1 Schneide über Mitte
- Oberfläche X.Cut beschichtet
- For micro toolmaking application
- Reduced diameter after cutting edge
- Center cutting
- With X.Cut coating

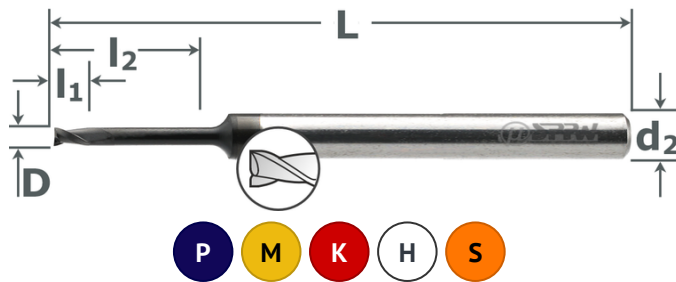

VHM	X Cut
z:2	DIN 6535HA
micro NECK	sharp

ØD -0.01	Ød2 h5	L	l1	l2	z	Art. No.
0,4	3	39	0,4	2	2	6785070042
0,5	3	39	0,55	2	2	6785070052
0,5	3	39	0,55	4	2	6785070054
0,5	3	60	0,55	6	2	6785070056
0,6	3	39	0,7	4	2	6785070064
0,7	3	39	0,85	4	2	6785070074
0,8	3	39	1	4	2	6785070084
0,8	3	39	1	6	2	6785070086
0,8	3	60	1	9	2	6785070089
0,9	3	39	1,15	6	2	6785070096
1	3	60	1,3	12	2	6785070101
1	3	39	1,3	4	2	6785070104
1	3	39	1,3	6	2	6785070106
1	3	39	1,3	9	2	6785070109

ØD -0.01	Ød2 h5	L	l1	l2	z	Art. No.
1,2	3	39	1,6	6	2	6785070126
1,2	3	39	1,6	9	2	6785070129
1,4	3	39	1,9	6	2	6785070146
1,4	3	39	1,9	9	2	6785070149
1,5	3	60	2,05	12	2	6785070151
1,5	3	39	2,05	6	2	6785070156
1,5	3	39	2,05	9	2	6785070159
1,8	3	39	2,5	12	2	6785070181
1,8	3	39	2,5	9	2	6785070189
2	3	39	2,8	9	2	6785070209
2	3	39	2,8	12	2	6785070212
2	3	60	2,8	15	2	6785070215
2,5	3	60	3,55	15	2	6785070251



- 3 extrem scharfe Schneidkanten
- Kurze, stabile Ausföhrung
- Verstärkter Zylinderschaft
- Zentrumschnitt 1 Schneide über Mitte
- Oberfläche poliert
- 3 flutes, sharp cutting edges
- Short series with high rigidity
- Reinforced cylindrical shank
- Center cutting
- Polished finish

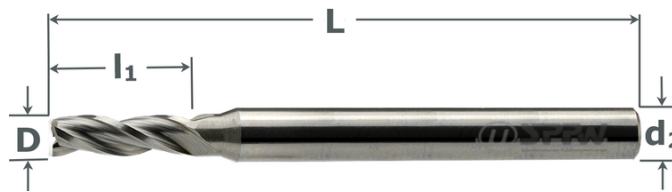

VHM	poliert
micro N	z:3
DIN 6535HA	sharp

668533 - 2-3xØ

ØD -0.01	Ød2 h5	L	l1	Art. No.	ØD -0.01	Ød2 h5	L	l1	Art. No.
0,5	3	39	1,5	6685330050	1,8	3	39	5	6685330180
0,6	3	39	1,5	6685330060	1,9	3	39	5	6685330190
0,7	3	39	2	6685330070	2	3	39	5	6685330200
0,8	3	39	2	6685330080	2,1	3	39	6	6685330210
0,9	3	39	2,5	6685330090	2,2	3	39	6	6685330220
1	3	39	3	6685330100	2,3	3	39	6	6685330230
1,1	3	39	3	6685330110	2,4	3	39	6	6685330240
1,2	3	39	4	6685330120	2,5	3	39	7	6685330250
1,3	3	39	4	6685330130	2,6	3	39	7	6685330260
1,4	3	39	4	6685330140	2,7	3	39	7	6685330270
1,5	3	39	4	6685330150	2,8	3	39	7	6685330280
1,6	3	39	5	6685330160	2,9	3	39	7	6685330290
1,7	3	39	5	6685330170	3	4	44	10	6685330300

668537 - 1,5xØ

ØD -0.01	Ød2 h5	L	l1	Art. No.	ØD -0.01	Ød2 h5	L	l1	Art. No.
0,3	3	39	0,45	6685370030	1,2	3	39	1,8	6685370120
0,4	3	39	0,6	6685370040	1,4	3	39	2,1	6685370140
0,5	3	39	0,75	6685370050	1,5	3	39	2,25	6685370150
0,6	3	39	0,9	6685370060	1,8	3	39	2,7	6685370180
0,8	3	39	1,2	6685370080	2	3	39	3	6685370200
1	3	39	1,5	6685370100	2,5	3	39	3,75	6685370250

Micro z3

Micro-Bohrnutenfräser VHM+X.Cut 3 Schneiden 1/10 steigend Carbide Micro End Mills+X.Cut 3 Flutes 1/10 increments



- 3 extrem scharfe Schneidkanten
- Kurze, stabile Ausführung
- Verstärkter Zylinderschaft
- Zentrumschnitt 1 Schneide über Mitte
- Oberfläche X.Cut beschichtet
- 3 flutes, sharp cutting edges
- Short series with high rigidity
- Reinforced cylindrical shank
- Center cutting
- With X.Cut coating

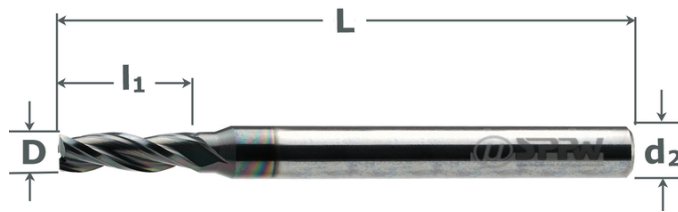

VHM	X Cut
micro N	z:3
DIN 6535HA	sharp

678533 - 2-3xØ

ØD -0.01	Ød2 h5	L	l1	Art. No.	ØD -0.01	Ød2 h5	L	l1	Art. No.
0,5	3	39	1,5	6785330050	1,8	3	39	5	6785330180
0,6	3	39	1,5	6785330060	1,9	3	39	5	6785330190
0,7	3	39	2	6785330070	2	3	39	5	6785330200
0,8	3	39	2	6785330080	2,1	3	39	6	6785330210
0,9	3	39	2,5	6785330090	2,2	3	39	6	6785330220
1	3	39	3	6785330100	2,3	3	39	6	6785330230
1,1	3	39	3	6785330110	2,4	3	39	6	6785330240
1,2	3	39	4	6785330120	2,5	3	39	7	6785330250
1,3	3	39	4	6785330130	2,6	3	39	7	6785330260
1,4	3	39	4	6785330140	2,7	3	39	7	6785330270
1,5	3	39	4	6785330150	2,8	3	39	7	6785330280
1,6	3	39	5	6785330160	2,9	3	39	7	6785330290
1,7	3	39	5	6785330170	3	4	44	10	6785330300

678537 - 1,5xØ

ØD -0.01	Ød2 h5	L	l1	Art. No.	ØD -0.01	Ød2 h5	L	l1	Art. No.
0,3	3	39	0,45	6785370030	1,2	3	39	1,8	6785370120
0,4	3	39	0,6	6785370040	1,4	3	39	2,1	6785370140
0,5	3	39	0,75	6785370050	1,5	3	39	2,25	6785370150
0,6	3	39	0,9	6785370060	1,8	3	39	2,7	6785370180
0,8	3	39	1,2	6785370080	2	3	39	3	6785370200
1	3	39	1,5	6785370100	2,5	3	39	3,75	6785370250

H



- Nut-/Umfang in Sonderlegierungen
- Werkstoffe mit hoher Zugfestigkeit
- Eingriffstiefe bis $3 \times \varnothing$
- Mit Schutzfase 45°
- Oberfläche X.Cut beschichtet
- Slotting, contouring in special alloys
- Materials with high hardness
- Flute length $3 \times \varnothing$
- With protection chamfer 45°
- Center cutting and 45° helix
- With X.Cut coating

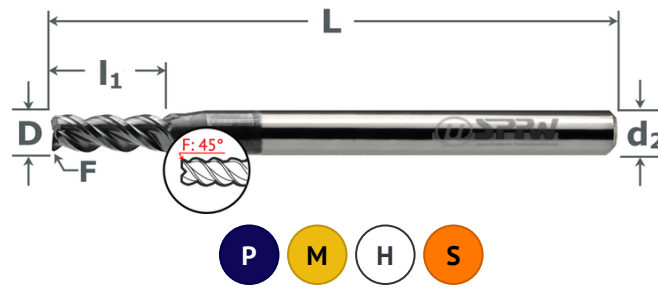

VHM	X Cut
$3 \times \varnothing$	z: 2-3
DIN 6535HA	micro 2-3 $\times \varnothing$
Fase ch:45°	

$\varnothing D$	$\varnothing d2$	L	l1	z	Art. No.
-0.01	h5				
0,5	3	39	1,5	2	6785300050
0,6	3	39	1,5	2	6785300060
0,8	3	39	2	2	6785300080
1	3	39	3	3	6785300100

$\varnothing D$	$\varnothing d2$	L	l1	z	Art. No.
-0.01	h5				
1,2	3	39	4	3	6785300120
1,5	3	39	4	3	6785300150
2	3	39	5	3	6785300200
2,5	3	39	7	3	6785300250

— INFO —

OPTIMAG - AUSSERGEWÖHNLICHE FRÄSER FÜR DEN KLEINSTFORMENBAU

OptiMag Hochvorschub/Hochgenauigkeits-Fräser bieten dem Anwender den ultimativen Kompromiss zwischen Bearbeitungsgeschwindigkeit und Präzision.

Herkömmliche Bearbeitungsstrategien im Mikro-Formenbau sehen niedrige Zahnvorschübe von wenigen Mikrometern vor. Die robuste Geometrie unser OPTIMAG-Microfräser ermöglicht Ihnen deutlich höhere Vorschübe. Diese erleichtern dem Fräser das Schneiden und garantieren gleichzeitig die Stabilität des Werkzeugs, womit sich deutlich bessere Werkzeugstandzeiten und hochpräzise Oberflächen erzielen lassen.

- Mehr Stabilität und Steifigkeit durch höhere Kerndicke
- Engste Radiustoleranzen von $\pm 2 \mu\text{m}$ für mehr Präzision
- Optimierter radialer Übergang zwischen Schneide und Schaft reduziert Vibrationen
- Neues Hartmetall-Substrat mit hervorragender Zähigkeit bei extremer Steifigkeit
- Robuste Schneidengeometrie für lange Werkzeuglebensdauer

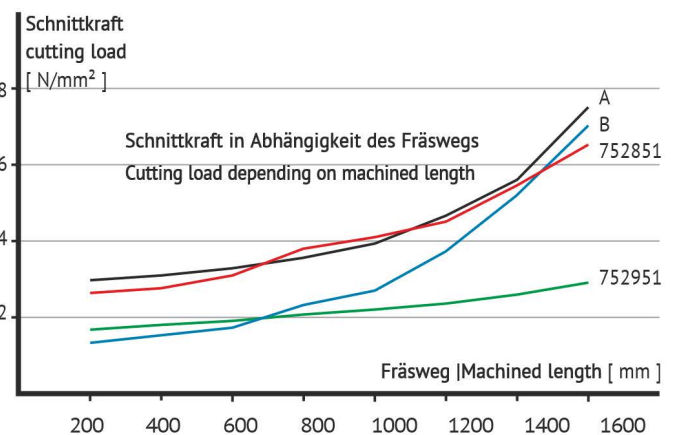
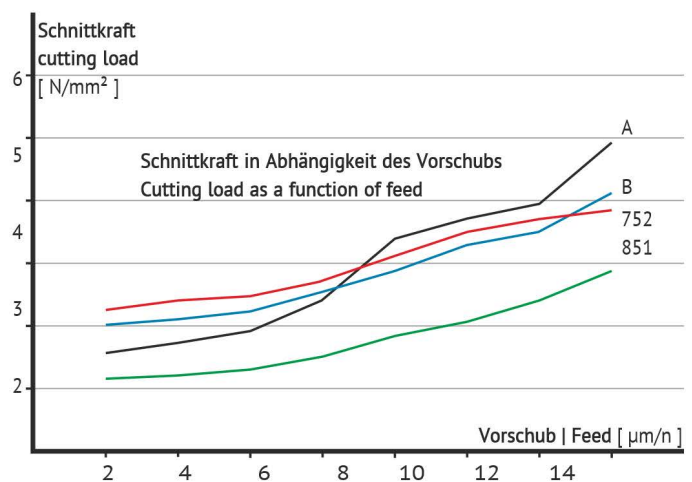



- Radiustoleranz $\pm 0,002$
- Gehärtete Stählen bis 65 HRC
- Erhöhte Eingriffstiefe an Formschräge
- Optimierte HSC-Schaftgeometrie
- Für höhere Laufruhe und Lebensdauer
- Oberfläche X.Cut beschichtet

- Radius tolerance $\pm 0,002$
- Milling of hardened steels 65 HRC
- Extended deep milling, mold making
- Optimized HSC geometry
- No vibrations and long tool life
- With X.Cut coating

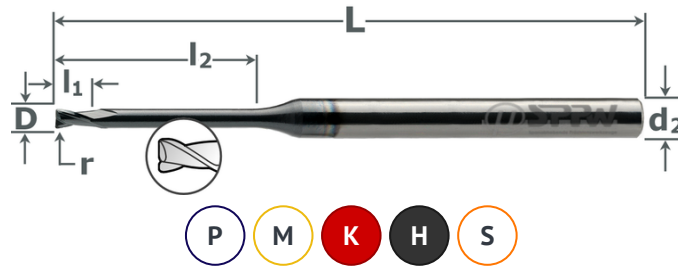

ØD h7	Ød2 h5	L	l1	l2	r ±0,002	Art. No.	ØD h7	Ød2 h5	L	l1	l2	r ±0,002	Art. No.
0,3	4	45	0,25	1	0,05	7529510301	1,0	4	50	1,3	6	0,05	7529511006
0,3	4	45	0,25	2	0,05	7529510302	1,0	4	50	1,3	8	0,05	7529511008
0,3	4	45	0,25	3	0,05	7529510303	1,0	4	50	1,3	10	0,05	7529511010
0,3	4	45	0,45	--	0,05	7529510345	1,0	4	50	1,3	12	0,05	7529511012
0,4	4	45	0,4	1	0,05	7529510401	1,0	4	50	1,3	16	0,05	7529511016
0,4	4	45	0,4	2	0,05	7529510402	1,0	4	50	1,3	20	0,05	7529511020
0,4	4	45	0,4	3	0,05	7529510403	1,0	4	50	1,5	--	0,05	7529511050
0,4	4	45	0,4	4	0,05	7529510404	1,0	4	60	1,5	--	0,05	7529511060
0,4	4	45	0,6	--	0,05	7529510445	1,2	4	50	1,6	6	0,06	7529511206
0,5	4	45	0,55	2	0,05	7529510502	1,2	4	50	1,6	8	0,06	7529511208
0,5	4	45	0,55	3	0,05	7529510503	1,2	4	50	1,6	10	0,06	7529511210
0,5	4	45	0,55	4	0,05	7529510504	1,2	4	50	1,6	12	0,06	7529511212
0,5	4	45	0,55	6	0,05	7529510506	1,2	4	50	1,6	16	0,06	7529511216
0,5	4	45	0,55	8	0,05	7529510508	1,2	4	50	1,8	--	0,06	7529511250
0,5	4	45	0,55	10	0,05	7529510510	1,2	4	60	1,8	--	0,06	7529511260
0,5	4	45	0,75	--	0,05	7529510545	1,4	4	50	1,9	6	0,07	7529511406
0,6	4	45	0,7	2	0,05	7529510602	1,4	4	50	1,9	8	0,07	7529511408
0,6	4	45	0,7	3	0,05	7529510603	1,4	4	50	1,9	10	0,07	7529511410
0,6	4	45	0,7	4	0,05	7529510604	1,4	4	50	1,9	12	0,07	7529511412
0,6	4	45	0,7	6	0,05	7529510606	1,4	4	50	2,1	--	0,07	7529511450
0,6	4	45	0,7	8	0,05	7529510608	1,5	4	50	2,05	4	0,075	7529511504
0,6	4	45	0,7	10	0,05	7529510610	1,5	4	50	2,05	6	0,075	7529511506
0,6	4	45	0,9	--	0,05	7529510645	1,5	4	50	2,05	8	0,075	7529511508
0,7	4	45	0,85	2	0,05	7529510702	1,5	4	50	2,05	10	0,075	7529511510
0,7	4	45	0,85	4	0,05	7529510704	1,5	4	50	2,05	12	0,075	7529511512
0,7	4	45	0,85	6	0,05	7529510706	1,5	4	60	2,05	16	0,075	7529511516
0,7	4	45	0,85	8	0,05	7529510708	1,5	4	60	2,05	20	0,075	7529511520
0,7	4	45	0,85	10	0,05	7529510710	1,5	4	50	2,25	--	0,075	7529511550
0,7	4	45	1,05	--	0,05	7529510745	1,5	4	60	2,25	--	0,075	7529511560
0,8	4	45	1,2	--	0,05	7529510800	1,6	4	50	2,2	6	0,08	7529511606
0,8	4	45	1	4	0,05	7529510804	1,6	4	50	2,2	8	0,08	7529511608
0,8	4	45	1	6	0,05	7529510806	1,6	4	50	2,2	10	0,08	7529511610
0,8	4	45	1	8	0,05	7529510808	1,6	4	50	2,2	12	0,08	7529511612
0,8	4	45	1	10	0,05	7529510810	1,6	4	50	2,2	16	0,08	7529511616
0,8	4	45	1	12	0,05	7529510812	1,6	4	50	2,4	--	0,08	7529511650
1,0	4	50	1,3	4	0,05	7529511004	1,6	4	50	2,4	--	0,08	7529511660



- Radiustoleranz ±0,002
- Gehärtete Stählen bis 65 HRC
- Erhöhte Eingriffstiefe an Formschräge
- Optimierte HSC-Schaftgeometrie
- Für höhere Laufruhe und Lebensdauer
- Oberfläche X.Cut beschichtet
- Radius tolerance ±0,002
- Milling of hardened steels 65 HRC
- Extended deep milling, mold making
- Optimized HSC geometry
- No vibrations and long tool life
- With X.Cut coating

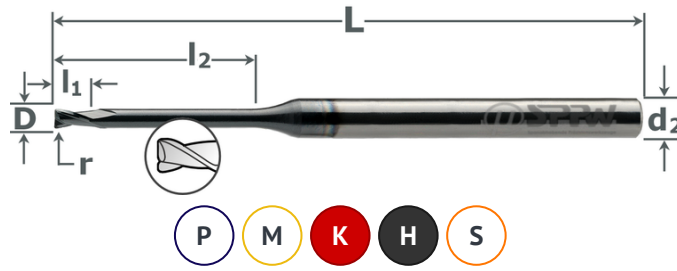

VHM	X Cut
micro H	z:2
DIN 6535HA	Hals neck
Torus R=0,002	

ØD h7	Ød2 h5	L	l1	l2	r ±0,002	Art. No.
2,0	4	50	2,8	6	0,1	7529512006
2,0	4	50	2,8	8	0,1	7529512008
2,0	4	50	2,8	10	0,1	7529512010
2,0	4	50	2,8	12	0,1	7529512012
2,0	4	60	2,8	16	0,1	7529512016
2,0	4	60	2,8	20	0,1	7529512020
2,0	4	70	2,8	25	0,1	7529512025
2,0	4	70	2,8	30	0,1	7529512030
2,0	4	50	3	--	0,1	7529512050
2,0	4	60	3	--	0,1	7529512060
2,0	4	70	3	--	0,1	7529512070
2,5	4	50	3,55	8	0,125	7529512508
2,5	4	50	3,55	10	0,125	7529512510
2,5	4	50	3,55	12	0,125	7529512512
2,5	4	60	3,55	16	0,125	7529512516
2,5	4	60	3,55	20	0,125	7529512520
2,5	4	70	3,55	25	0,125	7529512525
2,5	4	70	3,55	30	0,125	7529512530
2,5	4	50	3,75	--	0,125	7529512550
2,5	4	60	3,75	--	0,125	7529512560
2,5	4	70	3,75	--	0,125	7529512570
3,0	6	60	4,3	8	0,15	7529513008
3,0	6	60	4,3	10	0,15	7529513010
3,0	6	60	4,3	12	0,15	7529513012
3,0	6	60	4,3	16	0,15	7529513016
3,0	6	60	4,3	20	0,15	7529513020
3,0	6	75	4,3	25	0,15	7529513025

ØD h7	Ød2 h5	L	l1	l2	r ±0,002	Art. No.
3,0	6	75	4,3	30	0,15	7529513030
3,0	6	100	4,3	40	0,15	7529513040
3,0	6	60	4,5	--	0,15	7529513060
3,0	6	75	4,5	--	0,15	7529513075
3,0	6	100	4,5	--	0,15	7529513099
4,0	6	60	5,8	12	0,2	7529514012
4,0	6	60	5,8	16	0,2	7529514016
4,0	6	60	5,8	20	0,2	7529514020
4,0	6	75	5,8	25	0,2	7529514025
4,0	6	75	5,8	30	0,2	7529514030
4,0	6	100	5,8	40	0,2	7529514040
4,0	6	60	6	--	0,2	7529514060
4,0	6	75	6	--	0,2	7529514075
4,0	6	100	6	--	0,2	7529514099
5,0	6	60	7,3	16	0,25	7529515016
5,0	6	60	7,3	20	0,25	7529515020
5,0	6	75	7,3	25	0,25	7529515025
5,0	6	75	7,3	30	0,25	7529515030
5,0	6	100	7,3	40	0,25	7529515040
5,0	6	60	7,5	--	0,25	7529515060
5,0	6	75	7,5	--	0,25	7529515075
5,0	6	100	7,5	--	0,25	7529515099
6,0	6	75	8,8	20	0,3	7529516020
6,0	6	75	8,8	30	0,3	7529516030
6,0	6	75	8,8	40	0,3	7529516040
6,0	6	75	9	--	0,3	7529516075

H



- Radiustoleranz $\pm 0,002$
- Gehärtete Stähle bis 65 HRC
- Erhöhte Eingriffstiefe an Formschräge
- Optimierte HSC-Schaftgeometrie
- Höhere Laufruhe und Lebensdauer
- Oberfläche X.Cut beschichtet

- Enhanced radius tolerance $\pm 0,002$
- Milling of treated steels 65 HRC
- Extended deep milling
- Optimized HSC geometry
- No vibrations and longer tool life
- With X.Cut coating

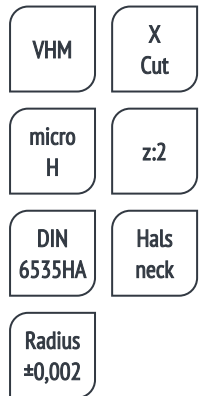
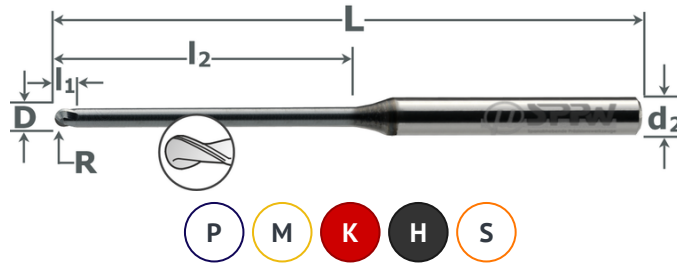

ØD h7	Ød2 h5	L	l1	l2	r ±0,002	Art. No.
0,3	4	45	0,25	1	0,15	7529520301
0,3	4	45	0,25	2	0,15	7529520302
0,3	4	45	0,25	3	0,15	7529520303
0,3	4	45	0,45	--	0,15	7529520345
0,4	4	45	0,4	1	0,2	7529520401
0,4	4	45	0,4	2	0,2	7529520402
0,4	4	45	0,4	3	0,2	7529520403
0,4	4	45	0,4	4	0,2	7529520404
0,4	4	45	0,6	--	0,2	7529520445
0,5	4	45	0,55	2	0,25	7529520502
0,5	4	45	0,55	3	0,25	7529520503
0,5	4	45	0,55	4	0,25	7529520504
0,5	4	45	0,55	6	0,25	7529520506
0,5	4	45	0,55	8	0,25	7529520508
0,5	4	45	0,55	10	0,25	7529520510
0,5	4	45	0,75	--	0,25	7529520545
0,6	4	45	0,7	2	0,3	7529520602
0,6	4	45	0,7	3	0,3	7529520603
0,6	4	45	0,7	4	0,3	7529520604
0,6	4	45	0,7	6	0,3	7529520606
0,6	4	45	0,7	8	0,3	7529520608
0,6	4	45	0,7	10	0,3	7529520610
0,6	4	45	0,9	--	0,3	7529520645
0,7	4	45	0,85	2	0,35	7529520702
0,7	4	45	0,85	4	0,35	7529520704
0,7	4	45	0,85	6	0,35	7529520706
0,7	4	45	0,85	8	0,35	7529520708
0,7	4	45	0,85	10	0,35	7529520710
0,7	4	45	1,05	--	0,35	7529520745
0,8	4	45	1,2	,8	0,4	7529520800
0,8	4	45	1	4	0,4	7529520804
0,8	4	45	1	6	0,4	7529520806
0,8	4	45	1	8	0,4	7529520808
0,8	4	45	1	10	0,4	7529520810
0,8	4	45	1	12	0,4	7529520812
1,0	4	50	1,3	4	0,5	7529521004

ØD h7	Ød2 h5	L	l1	l2	r ±0,002	Art. No.
1,0	4	50	1,3	6	0,5	7529521006
1,0	4	50	1,3	8	0,5	7529521008
1,0	4	50	1,3	10	0,5	7529521010
1,0	4	50	1,3	12	0,5	7529521012
1,0	4	50	1,3	16	0,5	7529521016
1,0	4	50	1,3	20	0,5	7529521020
1,0	4	50	1,5	--	0,5	7529521050
1,0	4	60	1,5	--	0,5	7529521060
1,2	4	50	1,6	6	0,6	7529521206
1,2	4	50	1,6	8	0,6	7529521208
1,2	4	50	1,6	10	0,6	7529521210
1,2	4	50	1,6	12	0,6	7529521212
1,2	4	50	1,6	16	0,6	7529521216
1,2	4	50	1,8	--	0,6	7529521250
1,2	4	60	1,8	--	0,6	7529521260
1,4	4	50	1,9	6	0,7	7529521406
1,4	4	50	1,9	8	0,7	7529521408
1,4	4	50	1,9	10	0,7	7529521410
1,4	4	50	1,9	12	0,7	7529521412
1,4	4	50	2,1	--	0,7	7529521450
1,5	4	50	2,05	4	0,75	7529521504
1,5	4	50	2,05	6	0,75	7529521506
1,5	4	50	2,05	8	0,75	7529521508
1,5	4	50	2,05	10	0,75	7529521510
1,5	4	50	2,05	12	0,75	7529521512
1,5	4	60	2,05	16	0,75	7529521516
1,5	4	60	2,05	20	0,75	7529521520
1,5	4	50	2,25	--	0,75	7529521550
1,5	4	60	2,25	--	0,75	7529521560
1,6	4	50	2,2	6	0,8	7529521606
1,6	4	50	2,2	8	0,8	7529521608
1,6	4	50	2,2	10	0,8	7529521610
1,6	4	50	2,2	12	0,8	7529521612
1,6	4	50	2,2	16	0,8	7529521616
1,6	4	50	2,4	--	0,8	7529521650
1,6	4	50	2,4	--	0,8	7529521660



- Radiustoleranz $\pm 0,002$
- Gehärtete Stähle bis 65 HRC
- Erhöhte Eingriffstiefe an Formschräge
- Optimierte HSC-Schaftgeometrie
- Höhere Laufruhe und Lebensdauer
- Oberfläche X.Cut beschichtet

- Enhanced radius tolerance $\pm 0,002$
- Milling of treated steels 65 HRC
- Extended deep milling
- Optimized HSC geometry
- No vibrations and longer tool life
- With X.Cut coating

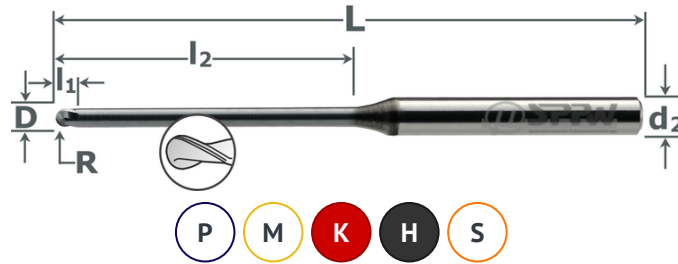

ØD h7	Ød2 h5	L	l1	l2	r ±0,002	Art. No.	ØD h7	Ød2 h5	L	l1	l2	r ±0,002	Art. No.
2,0	4	50	2,8	6	1	7529522006	3,0	6	75	4,3	30	1,5	7529523030
2,0	4	50	2,8	8	1	7529522008	3,0	6	100	4,3	40	1,5	7529523040
2,0	4	50	2,8	10	1	7529522010	3,0	6	60	4,5	--	1,5	7529523060
2,0	4	50	2,8	12	1	7529522012	3,0	6	75	4,5	--	1,5	7529523075
2,0	4	60	2,8	16	1	7529522016	3,0	6	100	4,5	--	1,5	7529523099
2,0	4	60	2,8	20	1	7529522020	4,0	6	60	5,8	12	2	7529524012
2,0	4	70	2,8	25	1	7529522025	4,0	6	60	5,8	16	2	7529524016
2,0	4	70	2,8	30	1	7529522030	4,0	6	60	5,8	20	2	7529524020
2,0	4	50	3	--	1	7529522050	4,0	6	75	5,8	25	2	7529524025
2,0	4	60	3	--	1	7529522060	4,0	6	75	5,8	30	2	7529524030
2,0	4	70	3	--	1	7529522070	4,0	6	100	5,8	40	2	7529524040
2,5	4	50	3,55	8	1,25	7529522508	4,0	6	60	6	--	2	7529524060
2,5	4	50	3,55	10	1,25	7529522510	4,0	6	75	6	--	2	7529524075
2,5	4	50	3,55	12	1,25	7529522512	4,0	6	100	6	--	2	7529524099
2,5	4	60	3,55	16	1,25	7529522516	5,0	6	60	7,3	16	2,5	7529525016
2,5	4	60	3,55	20	1,25	7529522520	5,0	6	60	7,3	20	2,5	7529525020
2,5	4	70	3,55	25	1,25	7529522525	5,0	6	75	7,3	25	2,5	7529525025
2,5	4	70	3,55	30	1,25	7529522530	5,0	6	75	7,3	30	2,5	7529525030
2,5	4	50	3,75	--	1,25	7529522550	5,0	6	100	7,3	40	2,5	7529525040
2,5	4	60	3,75	--	1,25	7529522560	5,0	6	60	7,5	--	2,5	7529525060
2,5	4	70	3,75	--	1,25	7529522570	5,0	6	75	7,5	--	2,5	7529525075
3,0	6	60	4,3	8	1,5	7529523008	5,0	6	100	7,5	--	2,5	7529525099
3,0	6	60	4,3	10	1,5	7529523010	6,0	6	75	8,8	20	3	7529526020
3,0	6	60	4,3	12	1,5	7529523012	6,0	6	75	8,8	30	3	7529526030
3,0	6	60	4,3	16	1,5	7529523016	6,0	6	75	8,8	40	3	7529526040
3,0	6	60	4,3	20	1,5	7529523020	6	6	75	9	--	3	7529526075
3,0	6	75	4,3	25	1,5	7529523025							

752 853

Micro-Schaftfräser VHM+Z.Cut Formenbau Carbide Micro End Mills+Z.Cut Moldmaking



- 3D-Bearbeitung von Aluminium
- Freigestellt für Eingriffstiefen
- Schneidecken für flachen Nutgrund
- Durchmesser-Toleranz -0,01/-0,02
- Oberfläche Z.Cut beschichtet
- 3D milling of aluminum
- Long reach
- Edges for flat slots
- Diameter tolerance -0,01/-0,02
- With Z.Cut coating

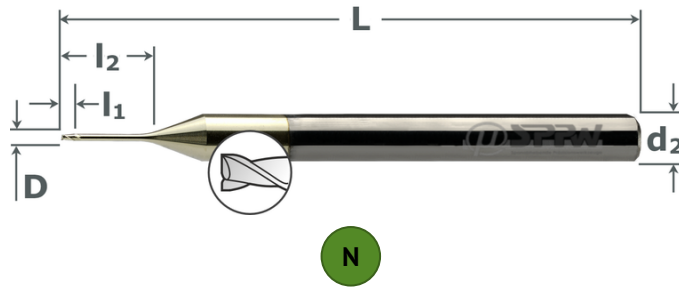

VHM	Z Cut
micro W	z:2
DIN 6535HA	Hals neck
sharp	

ØD -0.02	Ød2 h6	L	l1	l2	Art. No.
0,4	4	50	0,5	2,5	7528530402
0,5	4	50	0,6	6	7528530506
0,6	4	50	0,7	6	7528530606
0,8	4	50	1	7	7528530807
1	4	50	2	8	7528531008
1	4	50	2	12	7528531012
1,5	4	50	2,5	10	7528531510
1,5	4	50	2,5	15	7528531515

ØD -0.02	Ød2 h6	L	l1	l2	Art. No.
2	4	50	3	12	7528532012
2	4	50	3	16	7528532016
3	4	50	5	12	7528533012
3	4	60	5	18	7528533018
4	6	60	8	16	7528534016
5	6	60	10	17	7528535017
6	6	60	12	21	7528536021

752 854

Micro-Torusfräser VHM+Z.Cut Formenbau Carbide Micro Corner Radius End Mills+Z.Cut Moldmaking



- 3D-Bearbeitung von Aluminium
- Freigestellt für Eingriffstiefen
- Mit Eckenradius
- Durchmesser-Toleranz -0,01/-0,02
- Oberfläche Z.Cut beschichtet
- 3D milling of aluminum
- Long reach
- With corner radius
- Diameter tolerance -0,01/-0,02
- With Z.Cut coating

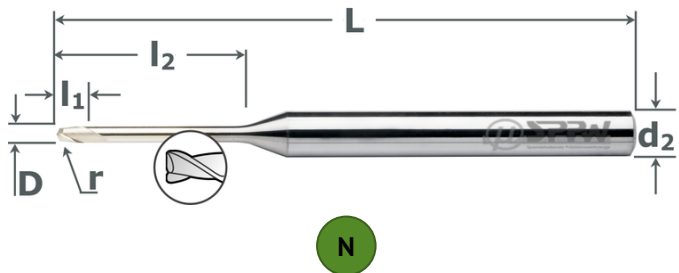

VHM	Z Cut
micro W	z:2
DIN 6535HA	Hals neck
ER Torus	

ØD -0.02	Ød2 h6	L	l1	l2	r Radius	Art. No.
1	4	50	1,2	8	0,1	7528541008
1	4	50	1,2	12	0,1	7528541012
1,5	4	50	1,8	10	0,1	7528541510
1,5	4	50	1,8	15	0,1	7528541515
2	4	50	2,2	12	0,1	7528542012
2	4	50	2,2	16	0,1	7528542016

ØD -0.02	Ød2 h6	L	l1	l2	r Radius	Art. No.
3	4	60	7	18	0,2	7528543018
3	4	60	7	25	0,2	7528543025
4	6	60	8	16	0,5	7528544016
4	6	60	8	20	0,5	7528544020
5	6	60	10	17	0,5	7528545017
6	6	60	12	21	1	7528546021

752 855

Micro-Radiusfräser VHM+Z.Cut Formenbau
Carbide Micro Radius End Mills+Z.Cut Moldmaking



- 3D-Bearbeitung von Aluminium
- Freigestellt für Eingriffstiefen
- Vollradius für Kopierarbeiten
- Radius-Toleranz ±0,01
- Oberfläche Z.Cut beschichtet
- 3D milling of aluminum
- Long reach
- Radius for copying operations
- Radius Tolerance ±0,01
- With Z.Cut coating

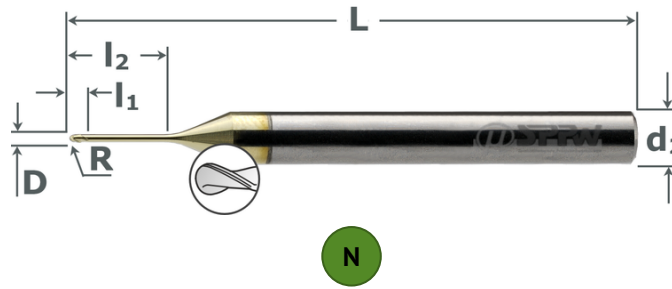

VHM	Z Cut
micro W	z:2
DIN 6535HA	Hals neck
Radius	

ØD	Ød2	L	l1	l2	R	Art. No.
-0.02	h6				Radius	
0,3	4	50	0,4	2	0,15	7528550302
0,3	4	50	0,4	4	0,15	7528550304
0,4	4	50	0,4	1,5	0,2	7528550402
0,5	4	50	0,6	2	0,25	7528550502
0,5	4	50	0,6	5	0,25	7528550505
0,6	4	50	0,7	2	0,3	7528550602
0,6	4	50	0,7	5	0,3	7528550605
0,8	4	50	0,8	4	0,4	7528550804
0,8	4	50	0,8	8	0,4	7528550808
1	4	50	1,2	8	0,5	7528551008

ØD	Ød2	L	l1	l2	R	Art. No.
-0.02	h6				Radius	
1	4	50	1,2	12	0,5	7528551012
1,5	4	50	1,8	10	0,75	7528551510
1,5	4	50	1,8	15	0,75	7528551515
2	4	50	4	12	1	7528552012
2	4	50	4	16	1	7528552016
3	4	50	6	12	1,5	7528553012
3	4	60	6	18	1,5	7528553018
4	6	60	8	16	2	7528554016
5	6	60	10	17	2,5	7528555017
6	6	60	12	21	3	7528556021

H

678 522

Micro-Kugelfräser VHM+X.Cut 220° mit Freistellung
Carbide Micro Radius End Mills+X.Cut 220° with Long Reach



- Zur 3D-Bearbeitung im Formenbau
- Für HSC, Hart-/Trockenbearbeitung
- Eingriffstiefe 5xØ
- Freistellung nach der Schneide
- Oberfläche X.Cut beschichtet
- 3D copy milling for toolmakers
- For HSC, hard- and dry milling
- Cutting length 5xØ
- Back clearance after cutting edge
- With X.Cut coating

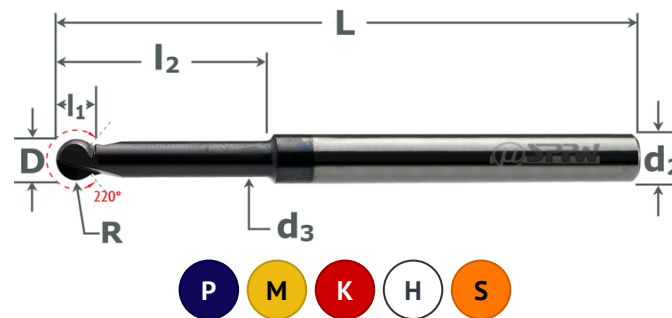

VHM	X Cut
5xØ	z:2
DIN 6535HA	micro NECK
220° Radius	

ØD	Ød1	Ød2	L	l1	l2	z	r	Art. No.
±0,02		h6					Radius	
0,8	0,7	3	60	0,55	4	2	0,4	6785220080
1	0,85	3	60	0,7	5	2	0,5	6785220100
1,2	1	3	60	0,8	6	2	0,6	6785220120
1,5	1,3	3	60	1	7,5	2	0,75	6785220150

ØD	Ød1	Ød2	L	l1	l2	z	r	Art. No.
±0,02		h6					Radius	
2	1,7	3	60	1,35	10	2	1	6785220200
3	2,6	6	75	2	15	2	1,5	6785220300
4	3,45	6	75	2,7	20	2	2	6785220400
5	4,3	6	75	3,4	25	2	2,5	6785220500

668 529

Micro-Radiusfräser VHM
Carbide Micro Radius End Mills



- Kurze, stabile Ausführung
- Für den universellen Einsatz
- Zentrumschnitt, scharfe Schneide
- Oberfläche poliert
- Short series with high rigidity
- For universal use
- Center cutting, sharp cutting edges
- Polished finish

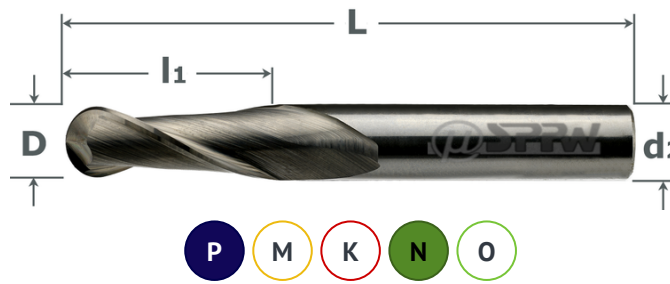

VHM	poliert
z:2	DIN 6535HA
micro 2-3xØ	Radius

ØD ±0,01	Ød2 h5	L	l1	z	r Radius	Art. No.
0,1	3	39	0,2	2	0,05	6685290010
0,15	3	39	0,3	2	0,075	6685290015
0,2	3	39	0,5	2	0,1	6685290020
0,25	3	39	0,5	2	0,125	6685290025
0,3	3	39	0,8	2	0,15	6685290030
0,35	3	39	0,8	2	0,175	6685290035
0,4	3	39	1	2	0,2	6685290040
0,5	3	39	1,5	2	0,25	6685290050
0,6	3	39	1,5	2	0,3	6685290060
0,7	3	39	2	2	0,35	6685290070
0,8	3	39	2	2	0,4	6685290080
0,9	3	39	2,5	2	0,45	6685290090
1	3	39	3	2	0,5	6685290100
1,1	3	39	3	2	0,55	6685290110
1,2	3	39	4	2	0,6	6685290120
1,4	3	39	4	2	0,7	6685290140

ØD ±0,01	Ød2 h5	L	l1	z	r Radius	Art. No.
1,5	3	39	4	2	0,75	6685290150
1,6	3	39	4	2	0,8	6685290160
1,8	3	39	5	2	0,9	6685290180
2	3	39	5	2	1	6685290200
2,5	3	39	7	2	1,25	6685290250
3	4	44	10	2	1,5	6685290300
3,5	4	44	10	2	1,75	6685290350
4	5	52	12	2	2	6685290400
4,5	5	52	12	2	2,25	6685290450
5	6	52	14	2	2,5	6685290500
5,5	6	52	14	2	2,75	6685290550
6	6	57	16	2	3	6685290600
7	8	63	18	2	3,5	6685290700
8	8	63	20	2	4	6685290800
9	10	72	22	2	4,5	6685290900
10	10	72	26	2	5	6685291000

668 521

Micro-Radiusfräser VHM Ultra kurz 0,75xØ
Carbide Micro Radius End Mills Ultra Short 0,75xØ



- Ultra kurze, stabile Ausführung
- Schneidenlänge 0,75xØ
- Für den universellen Einsatz
- Zentrumschnitt, scharfe Schneide
- Oberfläche poliert
- Ultra short series, high rigidity
- Cutting length 0,75xØ
- For universal use
- Center cutting, sharp cutting edges
- Polished finish

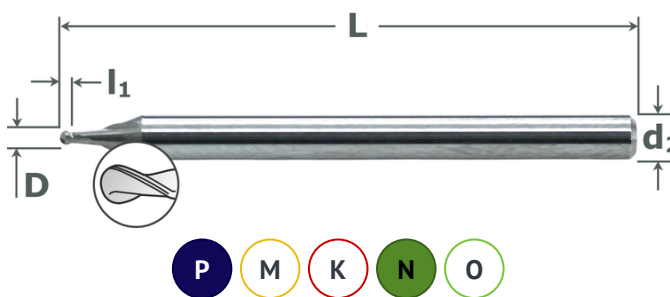

VHM	poliert
z:2	DIN 6535HA
micro 0,75xØ	Radius

ØD ±0,01	Ød2 h5	L	l1	z	r Radius	Art. No.
0,3	3	39	0,25	2	0,15	6685210030
0,4	3	39	0,3	2	0,2	6685210040
0,5	3	39	0,35	2	0,25	6685210050

ØD ±0,01	Ød2 h5	L	l1	z	r Radius	Art. No.
0,6	3	39	0,45	2	0,3	6685210060
0,8	3	39	0,6	2	0,4	6685210080
1	3	39	0,75	2	0,5	6685210100

668 527

Micro-Radiusfräser VHM Extra kurz 1,5xØ
Carbide Micro Radius End Mills Stub Series 1,5xØ



- Extra kurze, stabile Ausführung
- Schneidenlänge 1,5xØ
- Für den universellen Einsatz
- Zentrumschnitt, scharfe Schneide
- Oberfläche poliert
- Stub series, high rigidity
- Cutting length 1,5xØ
- For universal use
- Center cutting, sharp cutting edges
- Polished finish

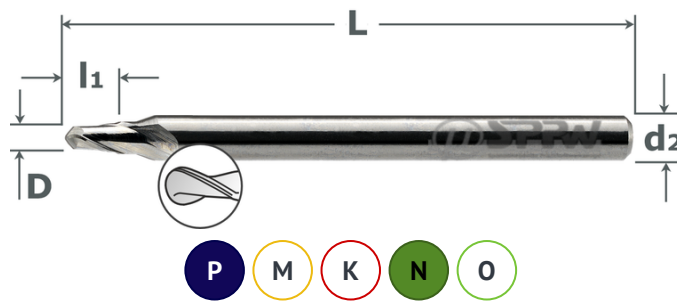

VHM	poliert
z:2	DIN 6535HA
micro 1,5xØ	Radius

ØD ±0,01	Ød2 h5	L	l1	z	r Radius	Art. No.
0,1	3	39	0,1	2	0,05	6685270010
0,15	3	39	0,2	2	0,075	6685270015
0,2	3	39	0,3	2	0,1	6685270020
0,25	3	39	0,35	2	0,125	6685270025
0,3	3	39	0,45	2	0,15	6685270030
0,4	3	39	0,6	2	0,2	6685270040
0,5	3	39	0,75	2	0,25	6685270050
0,6	3	39	0,9	2	0,3	6685270060
0,7	3	39	1,05	2	0,35	6685270070
0,8	3	39	1,2	2	0,4	6685270080
0,9	3	39	1,35	2	0,45	6685270090
1	3	39	1,5	2	0,5	6685270100
1,1	3	39	1,65	2	0,55	6685270110

ØD ±0,01	Ød2 h5	L	l1	z	r Radius	Art. No.
1,2	3	39	1,8	2	0,6	6685270120
1,3	3	39	1,9	2	0,65	6685270130
1,4	3	39	2,1	2	0,7	6685270140
1,5	3	39	2,25	2	0,75	6685270150
1,6	3	39	2,4	2	0,8	6685270160
1,7	3	39	2,55	2	0,85	6685270170
1,8	3	39	2,7	2	0,9	6685270180
2	3	39	3	2	1	6685270200
2,2	3	39	3,3	2	1,1	6685270220
2,4	3	39	3,6	2	1,2	6685270240
2,5	3	39	3,75	2	1,25	6685270250
2,6	3	39	3,9	2	1,3	6685270260
2,8	3	39	4,2	2	1,4	6685270280

H

668 527 F

Micro-Radiusfräser VHM mit Freistellung
Carbide Micro Radius End Mills with Long Reach



- Anwendung im Kleinformenbau
- Freigeschliffener Hals
- Zentrumschnitt und scharfe Schneiden
- Oberfläche poliert
- For micro toolmaking application
- Reduced diameter after cutting edge
- Center cutting
- Polished finish

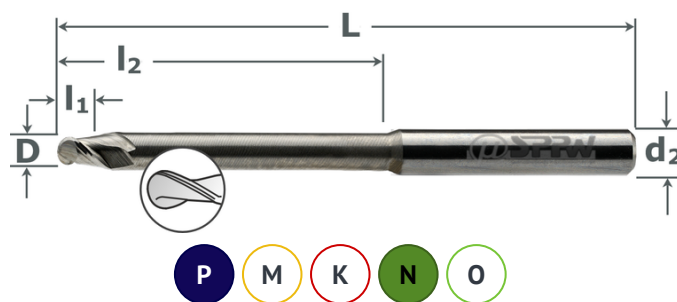

VHM	poliert
z:2	DIN 6535HA
micro NECK	Radius

ØD ±0,01	Ød2 h5	L	l1	l2	z	r Radius	Art. No.
0,4	3	39	0,4	2	2	0,2	6685270042
0,5	3	39	0,55	2	2	0,25	6685270052
0,5	3	39	0,55	4	2	0,25	6685270054
0,5	3	60	0,55	6	2	0,25	6685270056
0,6	3	39	0,7	4	2	0,3	6685270064
0,8	3	39	1	4	2	0,4	6685270084
0,8	3	39	1	6	2	0,4	6685270086
0,8	3	60	1	9	2	0,4	6685270089
1	3	60	1,3	12	2	0,5	6685270101
1	3	39	1,3	4	2	0,5	6685270104
1	3	39	1,3	5	2	0,5	6685270105

ØD ±0,01	Ød2 h5	L	l1	l2	z	r Radius	Art. No.
1	3	39	1,3	6	2	0,5	6685270106
1	3	39	1,3	9	2	0,5	6685270109
1,2	3	39	1,6	6	2	0,6	6685270126
1,5	3	60	2,05	12	2	0,75	6685270151
1,5	3	39	2,05	6	2	0,75	6685270156
1,5	3	39	2,05	9	2	0,75	6685270159
2	3	39	2,8	9	2	1	6685270209
2	3	39	2,8	12	2	1	6685270212
2	3	60	2,8	15	2	1	6685270215
2,5	4	44	3,55	12	2	1,25	6685270252
2,5	3	60	3,55	15	2	1,25	6685270255

678 529

Micro-Radiusfräser VHM+X.Cut
Carbide Micro Radius End Mills+X.Cut



- Kurze, stabile Ausführung
- Für den universellen Einsatz
- Zentrumschnitt, scharfe Schneide
- Oberfläche X.Cut beschichtet
- Short series with high rigidity
- For universal use
- Center cutting, sharp cutting edges
- With X.Cut coating

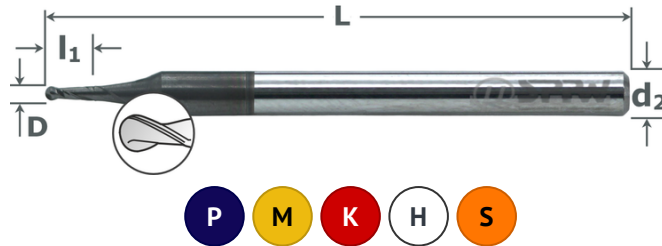

VHM	X Cut
z:2	DIN 6535HA
micro 2-3xØ	Radius

ØD ±0,01	Ød2 h5	L	l1	z	r Radius	Art. No.
0,1	3	39	0,2	2	0,05	6785290010
0,15	3	39	0,3	2	0,075	6785290015
0,2	3	39	0,5	2	0,1	6785290020
0,25	3	39	0,5	2	0,125	6785290025
0,3	3	39	0,8	2	0,15	6785290030
0,35	3	39	0,8	2	0,175	6785290035
0,4	3	39	1	2	0,2	6785290040
0,5	3	39	1,5	2	0,25	6785290050
0,6	3	39	1,5	2	0,3	6785290060
0,7	3	39	2	2	0,35	6785290070
0,8	3	39	2	2	0,4	6785290080
0,9	3	39	2,5	2	0,45	6785290090
1	3	39	3	2	0,5	6785290100
1,1	3	39	3	2	0,55	6785290110

ØD ±0,01	Ød2 h5	L	l1	z	r Radius	Art. No.
1,2	3	39	4	2	0,6	6785290120
1,4	3	39	4	2	0,7	6785290140
1,5	3	39	4	2	0,75	6785290150
1,6	3	39	4	2	0,8	6785290160
1,8	3	39	5	2	0,9	6785290180
2	3	39	5	2	1	6785290200
2,5	3	39	7	2	1,25	6785290250
3	4	44	10	2	1,5	6785290300
3,5	4	44	10	2	1,75	6785290350
4	5	52	12	2	2	6785290400
4,5	5	52	12	2	2,25	6785290450
5	6	52	14	2	2,5	6785290500
5,5	6	52	14	2	2,75	6785290550

678 521

Micro-Radiusfräser VHM+X.Cut Ultra kurz 0,75xØ
Carbide Micro Radius End Mills+X.Cut Ultra Short 0,75xØ



- Ultra kurze, stabile Ausführung
- Schneidenlänge 0,75xØ
- Für den universellen Einsatz
- Zentrumschnitt, scharfe Schneide
- Oberfläche X.Cut beschichtet
- Ultra short, high rigidity
- Cutting length 0,75xØ
- For universal use
- Center cutting, sharp cutting edges
- With X.Cut coating

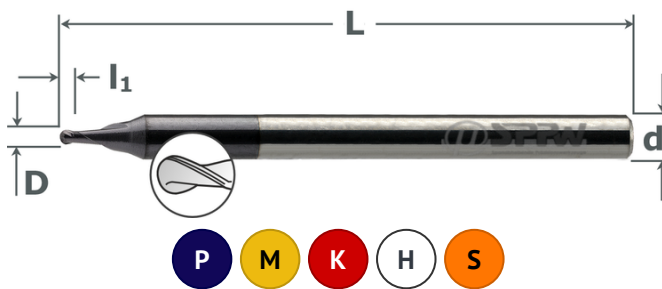

VHM	X Cut
z:2	DIN 6535HA
micro 0,75xØ	Radius

ØD ±0,01	Ød2 h5	L	l1	z	r Radius	Art. No.
0,3	3	39	0,25	2	0,15	6785210030
0,4	3	39	0,3	2	0,2	6785210040
0,5	3	39	0,35	2	0,25	6785210050

ØD ±0,01	Ød2 h5	L	l1	z	r Radius	Art. No.
0,6	3	39	0,45	2	0,3	6785210060
0,8	3	39	0,6	2	0,4	6785210080
1	3	39	0,75	2	0,5	6785210100

678 527

Micro-Radiusfräser VHM+X.Cut Extra kurz 1,5xØ
Carbide Micro Radius End Mills+X.Cut Stub Series 1,5xØ



- Extra kurze, stabile Ausführung
- Schneidenlänge 1,5xØ
- Für den universellen Einsatz
- Zentrumschnitt, scharfe Schneide
- Oberfläche X.Cut beschichtet
- Stub series, high rigidity
- Cutting length 1,5xØ
- For universal use
- Center cutting, sharp cutting edges
- With X.Cut coating

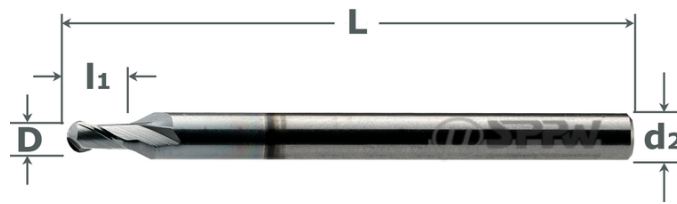

VHM	X Cut
z:2	DIN 6535HA
micro 1,5xØ	Radius

ØD ±0,01	Ød2 h5	L	l1	z	r Radius	Art. No.
0,1	3	39	0,1	2	0,05	6785270010
0,15	3	39	0,2	2	0,075	6785270015
0,2	3	39	0,3	2	0,1	6785270020
0,25	3	39	0,35	2	0,125	6785270025
0,3	3	39	0,45	2	0,15	6785270030
0,4	3	39	0,6	2	0,2	6785270040
0,5	3	39	0,75	2	0,25	6785270050
0,6	3	39	0,9	2	0,3	6785270060
0,7	3	39	1,05	2	0,35	6785270070
0,8	3	39	1,2	2	0,4	6785270080
0,9	3	39	1,35	2	0,45	6785270090
1	3	39	1,5	2	0,5	6785270100
1,1	3	39	1,65	2	0,55	6785270110

ØD ±0,01	Ød2 h5	L	l1	z	r Radius	Art. No.
1,2	3	39	1,8	2	0,6	6785270120
1,3	3	39	1,9	2	0,65	6785270130
1,4	3	39	2,1	2	0,7	6785270140
1,5	3	39	2,25	2	0,75	6785270150
1,6	3	39	2,4	2	0,8	6785270160
1,7	3	39	2,55	2	0,85	6785270170
1,8	3	39	2,7	2	0,9	6785270180
2	3	39	3	2	1	6785270200
2,2	3	39	3,3	2	1,1	6785270220
2,4	3	39	3,6	2	1,2	6785270240
2,5	3	39	3,75	2	1,25	6785270250
2,6	3	39	3,9	2	1,3	6785270260
2,8	3	39	4,2	2	1,4	6785270280

H

678 527 F

Micro-Radiusfräser VHM+X.Cut mit Freistellung
Carbide Micro Radius End Mills+X.Cut with Long Reach



- Anwendung im Kleinstformenbau
- Freigeschliffener Hals
- Zentrumschnitt und scharfe Schneide
- Oberfläche X.Cut beschichtet
- For micro toolmaking application
- Reduced diameter after cutting edge
- Center cutting
- With X.Cut coating

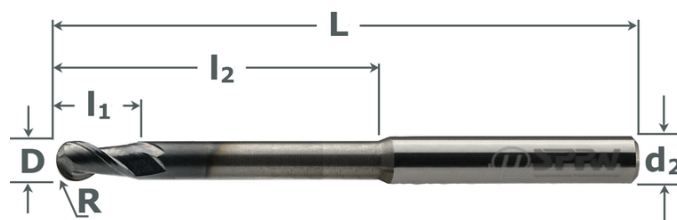

VHM	X Cut
micro NECK	z:2
DIN 6535HA	Radius

ØD ±0,01	Ød2 h5	L	l1	l2	z	r Radius	Art. No.
0,4	3	39	0,4	2	2	0,2	6785270042
0,5	3	39	0,55	2	2	0,25	6785270052
0,5	3	39	0,55	4	2	0,25	6785270054
0,5	3	60	0,55	6	2	0,25	6785270056
0,6	3	39	0,7	4	2	0,3	6785270064
0,8	3	39	1	4	2	0,4	6785270084
0,8	3	39	1	6	2	0,4	6785270086
0,8	3	60	1	9	2	0,4	6785270089
1	3	60	1,3	12	2	0,5	6785270101
1	3	39	1,3	4	2	0,5	6785270104

ØD ±0,01	Ød2 h5	L	l1	l2	z	r Radius	Art. No.
1	3	39	1,3	6	2	0,5	6785270106
1	3	39	1,3	9	2	0,5	6785270109
1,2	3	39	1,6	6	2	0,6	6785270126
1,5	3	60	2,05	12	2	0,75	6785270151
1,5	3	39	2,05	6	2	0,75	6785270156
1,5	3	39	2,05	9	2	0,75	6785270159
2	3	39	2,8	9	2	1	6785270209
2	3	39	2,8	12	2	1	6785270212
2	3	60	2,8	15	2	1	6785270215
2,5	3	60	3,55	15	2	1,25	6785270255



- Für die Grafitbearbeitung
- Kurze, stabile Ausführung
- Verstärkter Zylinderschaft Form HA
- Zentrumschnitt 1 Schneide über Mitte
- Oberfläche Diamant beschichtet
- For graphite
- Short series with high rigidity
- Reinforced cylindrical shank form HA
- Center cutting
- With diamond coating

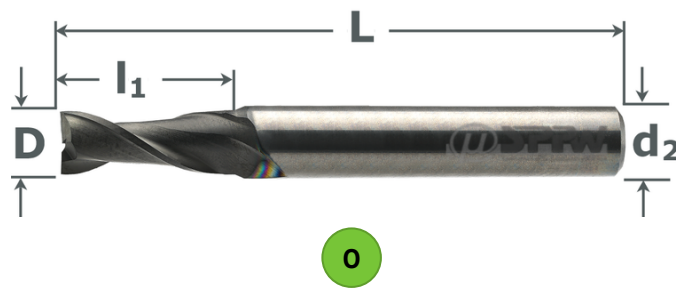

VHM	DIA Graph
micro N	z:2
DIN 6535HA	sharp

698500 - 2-3xØ

ØD h7	Ød2 h5	L	l1	z	Art. No.
0,3	3	39	0,8	2	6985000030
0,4	3	39	1	2	6985000040
0,5-0,6	3	39	1,5	2	698500xxxx
0,7-0,8	3	39	2	2	698500xxxx
0,9	3	39	2,5	2	6985000090
1	3	39	3	2	6985000100
1,1	3	39	3	2	6985000110
1,2-1,4	3	39	4	2	698500xxxx
1,5	3	39	4	2	6985000150
1,6-1,9	3	39	5	2	698500xxxx

ØD h7	Ød2 h5	L	l1	z	Art. No.
2	3	39	5	2	6985000200
2,1-2,4	3	39	6	2	698500xxxx
2,5	3	39	7	2	6985000250
2,6-2,9	3	39	7	2	698500xxxx
3	4	44	10	2	6985000300
3,1-3,9	4	44	10	2	698500xxxx
4	5	52	12	2	6985000400
4,1-4,9	5	52	12	2	698500xxxx
5	6	52	14	2	6985000500
5,1-5,9	6	52	14	2	698500xxxx

698507 - 1,5xØ

ØD h7	Ød2 h5	L	l1	z	Art. No.
0,3	3	39	0,45	2	6985070030
0,4	3	39	0,6	2	6985070040
0,5	3	39	0,75	2	6985070050
0,6	3	39	0,9	2	6985070060
0,7	3	39	1,05	2	6985070070
0,8	3	39	1,2	2	6985070080
0,9	3	39	1,35	2	6985070090
1	3	39	1,5	2	6985070100
1,1	3	39	1,65	2	6985070110

ØD h7	Ød2 h5	L	l1	z	Art. No.
1,2	3	39	1,8	2	6985070120
1,3	3	39	1,95	2	6985070130
1,4	3	39	2,1	2	6985070140
1,5	3	39	2,25	2	6985070150
1,6	3	39	2,4	2	6985070160
1,7	3	39	2,55	2	6985070170
1,8	3	39	2,7	2	6985070180
1,9	3	39	2,85	2	6985070190
2	3	39	3	2	6985070200

698509 - 5xØ

ØD h7	Ød2 h5	L	l1	z	Art. No.
0,4	3	39	2	2	6985090040
0,5	3	39	2,5	2	6985090050
0,6	3	39	3	2	6985090060
0,7	3	39	3,5	2	6985090070
0,8	3	39	4	2	6985090080
0,9	3	39	4,5	2	6985090090
1	3	39	5	2	6985090100
1,1	3	39	5,5	2	6985090110
1,2	3	39	6	2	6985090120

ØD h7	Ød2 h5	L	l1	z	Art. No.
1,3	3	39	6,5	2	6985090130
1,4	3	39	7	2	6985090140
1,5	3	39	7,5	2	6985090150
1,6	3	39	8	2	6985090160
1,7	3	39	8,5	2	6985090170
1,8	3	39	9	2	6985090180
1,9	3	39	9,5	2	6985090190
2	3	39	10	2	6985090200



698 510

Micro-Bohrnutenfräser VHM+Diamant Überlang 8xØ
Carbide Micro End Mills+Diamond Extra Long Series 8xØ



- Für die Grafitbearbeitung
- Überlang, scharfe Schneidkanten
- Schneidenlänge 8xØ
- Verstärkter Zylinderschaft Form HA
- Zentrumschnitt 1 Schneide über Mitte
- Oberfläche Diamant beschichtet

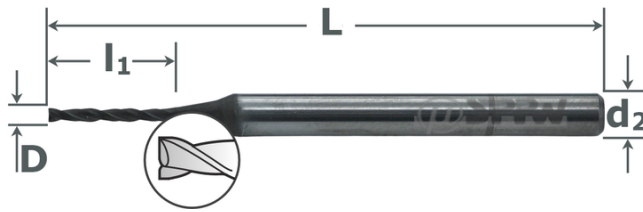

VHM	DIA Graph
z:2	DIN 6535HA
micro 8xØ	sharp

- For graphite
- Extra long, sharp cutting edges
- Cutting length 8xØ
- Reinforced cylindrical shank form HA
- Center cutting
- With diamond coating

ØD h7	Ød2 h5	L	l1	z	Art. No.
0,5	3	39	4	2	6985100050
0,6	3	39	4,8	2	6985100060
0,7	3	39	5,6	2	6985100070
0,8	3	39	6,4	2	6985100080
0,9	3	39	7,2	2	6985100090
1	3	39	8	2	6985100100
1,1	3	39	8,8	2	6985100110
1,2	3	39	9,6	2	6985100120
1,3	4	44	10,4	2	6985100130

ØD h7	Ød2 h5	L	l1	z	Art. No.
1,4	4	44	11,2	2	6985100140
1,5	4	44	12	2	6985100150
1,6	4	44	12,8	2	6985100160
1,7	4	44	13,6	2	6985100170
1,8	4	44	14,4	2	6985100180
1,9	4	44	15,2	2	6985100190
2	4	44	16	2	6985100200
2,5	5	60	20	2	6985100250
3	5	60	24	2	6985100300

698 507 F

Micro-Bohrnutenfräser VHM+Diamant mit Freistellung
Carbide Micro End Mills+Diamond with Long Reach



- Für die Grafitbearbeitung
- Extra kurz, extrem stabil
- Mit Freistellung nach der Schneide
- Verstärkter Zylinderschaft Form HA
- Zentrumschnitt 1 Schneide über Mitte
- Oberfläche Diamant beschichtet

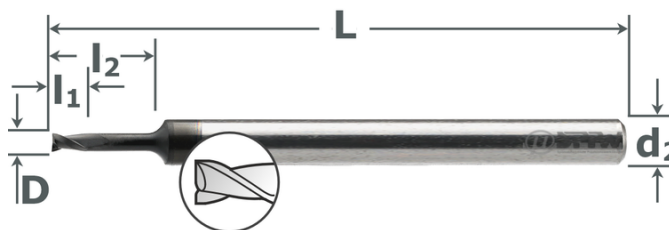

VHM	DIA Graph
z:2	DIN 6535HA
Hals neck	sharp

- For graphite
- Stub series, high rigidity
- Back clearance after cutting edges
- Reinforced cylindrical shank form HA
- Center cutting
- With diamond coating

ØD -0.01	Ød2 h5	L	l1	l2	z	Art. No.
0,4	3	39	0,4	2	2	6985070042
0,5	3	39	0,55	2	2	6985070052
0,5	3	39	0,55	4	2	6985070054
0,5	3	60	0,55	6	2	6985070056
0,6	3	39	0,7	4	2	6985070064
0,7	3	39	0,85	4	2	6985070074
0,8	3	39	1	4	2	6985070084
0,8	3	39	1	6	2	6985070086
0,8	3	60	1	9	2	6985070089
0,9	3	39	1,15	6	2	6985070096
1	3	60	1,3	12	2	6985070101
1	3	39	1,3	4	2	6985070104
1	3	39	1,3	6	2	6985070106
1	3	39	1,3	9	2	6985070109

ØD -0.01	Ød2 h5	L	l1	l2	z	Art. No.
1,2	3	39	1,6	6	2	6985070126
1,2	3	39	1,6	9	2	6985070129
1,4	3	39	1,9	6	2	6985070146
1,4	3	39	1,9	9	2	6985070149
1,5	3	60	2,05	12	2	6985070151
1,5	3	39	2,05	6	2	6985070156
1,5	3	39	2,05	9	2	6985070159
1,8	3	39	2,5	12	2	6985070181
1,8	3	39	2,5	9	2	6985070189
2	3	39	2,8	9	2	6985070209
2	3	39	2,8	12	2	6985070212
2	3	60	2,8	15	2	6985070215
2,5	3	60	3,55	15	2	6985070251

Diamant

Micro-Radiusfräser VHM+Diamant Kurz 3xØ Carbide Micro Radius End Mills+Diamond



- Für die Grafitbearbeitung
- Kurze, stabile Ausführung
- Verstärkter Zylinderschaft Form HA
- Zentrumschnitt 1 Schneide über Mitte
- Oberfläche Diamant beschichtet
- For graphite
- Short series with high rigidity
- Reinforced cylindrical shank form HA
- Center cutting - radius
- With diamond coating

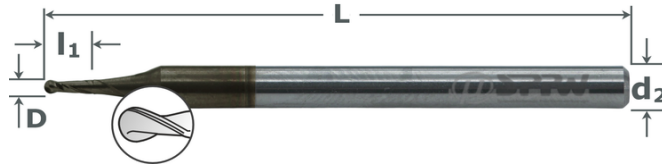

VHM	DIA Graph
z:2	DIN 6535HA
micro 2-3xØ	Radius

698529 - 2-3xØ

ØD -0,02	Ød2 h5	L	l1	z	r Radius	Art. No.
0,3	3	39	0,8	2	0,15	6985290030
0,4	3	39	1	2	0,2	6985290040
0,5	3	39	1,5	2	0,25	6985290050
0,6	3	39	1,5	2	0,3	6985290060
0,7	3	39	2	2	0,35	6985290070
0,8	3	39	2	2	0,4	6985290080
0,9	3	39	2,5	2	0,45	6985290090
1	3	39	3	2	0,5	6985290100
1,1	3	39	3	2	0,55	6985290110
1,2	3	39	4	2	0,6	6985290120
1,4	3	39	4	2	0,7	6985290140

ØD -0,02	Ød2 h5	L	l1	z	r Radius	Art. No.
1,5	3	39	4	2	0,75	6985290150
1,6	3	39	4	2	0,8	6985290160
1,8	3	39	5	2	0,9	6985290180
2	3	39	5	2	1	6985290200
2,5	3	39	7	2	1,25	6985290250
3	4	44	10	2	1,5	6985290300
3,5	4	44	10	2	1,75	6985290350
4	5	52	12	2	2	6985290400
4,5	5	52	12	2	2,25	6985290450
5	6	52	14	2	2,5	6985290500
5,5	6	52	14	2	2,75	6985290550

698 527 F

Micro-Radiusfräser VHM+Diamant mit Freistellung Carbide Micro Radius End Mills+Diamond with Long Reach



- Für die Grafitbearbeitung
- Mit Freistellung nach der Schneide
- Verstärkter Zylinderschaft Form HA
- Zentrumschnitt - Stirnradius
- Oberfläche Diamant beschichtet
- For graphite
- Back clearance after cutting edges
- Reinforced cylindrical shank form HA
- Center cutting - radius
- With diamond coating

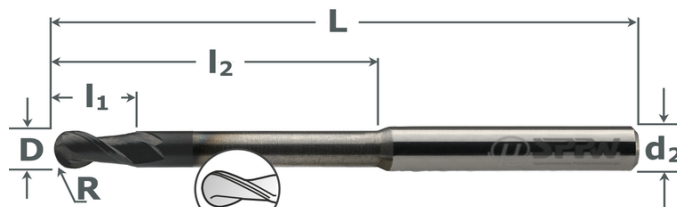

VHM	DIA Graph
z:2	DIN 6535HA
Hals neck	Radius

ØD -0,02	Ød2 h5	L	l1	l2	z	r Radius	Art. No.
0,4	3	39	0,4	2	2	0,2	6985270042
0,5	3	39	0,55	2	2	0,25	6985270052
0,5	3	39	0,55	4	2	0,25	6985270054
0,5	3	60	0,55	6	2	0,25	6985270056
0,6	3	39	0,7	4	2	0,3	6985270064
0,8	3	39	1	4	2	0,4	6985270084
0,8	3	39	1	6	2	0,4	6985270086
0,8	3	60	1	9	2	0,4	6985270089
1	3	60	1,3	12	2	0,5	6985270101
1	3	39	1,3	4	2	0,5	6985270104

ØD -0,02	Ød2 h5	L	l1	l2	z	r Radius	Art. No.
1	3	39	1,3	6	2	0,5	6985270106
1	3	39	1,3	9	2	0,5	6985270109
1,2	3	39	1,6	6	2	0,6	6985270126
1,5	3	60	2	12	2	0,75	6985270151
1,5	3	39	2,05	6	2	0,75	6985270156
1,5	3	39	2,05	9	2	0,75	6985270159
2	3	39	2,8	9	2	1	6985270209
2	3	39	2,8	12	2	1	6985270212
2	3	60	2,8	15	2	1	6985270215
2,5	3	60	3,55	15	2	1,25	6985270255



Spanabhebende Präzisionswerkzeuge

[DE] **Rapid Line**
Fräser für Moderne Werkstoffe

[EN] **Rapid Line**
Milling Cutters for Modern Materials



passion for precision
[Leidenschaft für Präzision]



Microfräser VHM

Carbide Micro End Mills

Art.No./Page

<input type="checkbox"/>	<input type="checkbox"/>		VHM	poliert	z:1	DIN 6535HA	micro 2-3xØ	sharp	668 515 Seite I 1
--------------------------	--------------------------	---	-----	---------	-----	------------	-------------	-------	-----------------------------

Einzahnfräser VHM

Carbide Single Flute End Mills

Art.No./Page

<input type="checkbox"/>	<input type="checkbox"/>		VHM	poliert	W 30°	z:1	DIN 6535HA	HAWK	750 074 Seite I 2
--------------------------	--------------------------	---	-----	---------	-------	-----	------------	------	-----------------------------

<input type="checkbox"/>	<input type="checkbox"/>		VHM	Dia HC	W 30°	z:1	DIN 6535HA	HAWK	750 074 HC Seite I 2
--------------------------	--------------------------	---	-----	--------	-------	-----	------------	------	--------------------------------

<input type="checkbox"/>	<input type="checkbox"/>		VHM	poliert	W 25°	z:1	DIN 6535HA		751 100 Seite I 3
--------------------------	--------------------------	---	-----	---------	-------	-----	------------	--	-----------------------------

<input type="checkbox"/>	<input type="checkbox"/>		VHM	poliert	W 25°	z:1	DIN 6535HA		751 110 Seite I 4
--------------------------	--------------------------	---	-----	---------	-------	-----	------------	--	-----------------------------

<input type="checkbox"/>	<input type="checkbox"/>		VHM	poliert	W 0°	z:1	DIN 6535HA		751 001 Seite I 5
--------------------------	--------------------------	---	-----	---------	------	-----	------------	--	-----------------------------

<input type="checkbox"/>	<input type="checkbox"/>		VHM	poliert	W 25°	z:1	DIN 6535HA	Radius	751 105 Seite I 5
--------------------------	--------------------------	---	-----	---------	-------	-----	------------	--------	-----------------------------

<input type="checkbox"/>	<input type="checkbox"/>		VHM	poliert	W 24°	z:1	DIN 6535HA	PLX	750 033 Seite I 6
--------------------------	--------------------------	--	-----	---------	-------	-----	------------	-----	-----------------------------

<input type="checkbox"/>	<input type="checkbox"/>		VHM	poliert	W 24°	z:1	DIN 6535HA	PLX	750 035 Seite I 6
--------------------------	--------------------------	---	-----	---------	-------	-----	------------	-----	-----------------------------

<input type="checkbox"/>	<input type="checkbox"/>		VHM	poliert	W 24°	z:1	DIN 6535HA	L lang PLX	750 037 Seite I 6
--------------------------	--------------------------	---	-----	---------	-------	-----	------------	------------	-----------------------------

Hochleistungsfräser VHM

Carbide High Performance End Mills

Art.No./Page

<input type="checkbox"/>	<input type="checkbox"/>		VHM	poliert	W 40°	z:2	DIN 6535HA	ER Torus	751 024 Seite I 7
--------------------------	--------------------------	---	-----	---------	-------	-----	------------	----------	-----------------------------

<input type="checkbox"/>	<input type="checkbox"/>		VHM	Alu Cut	W 40°	z:2	DIN 6535HA	ER Torus	751 024 A Seite I 7
--------------------------	--------------------------	---	-----	---------	-------	-----	------------	----------	-------------------------------

<input type="checkbox"/>	<input type="checkbox"/>		VHM	poliert	W 40°	z:2	DIN 6535HA	Radius	751 025 Seite I 8
--------------------------	--------------------------	---	-----	---------	-------	-----	------------	--------	-----------------------------



<input type="checkbox"/>	<input type="checkbox"/>		VHM	Alu Cut	W 40°	z:2	DIN 6535HA	ER Torus	751 025 A Seite I 8
--------------------------	--------------------------	---	-----	---------	-------	-----	------------	----------	-------------------------------

<input type="checkbox"/>	<input type="checkbox"/>		VHM	poliert	DIN 6527L	UT 45°	z:3	DIN 6535HA	751 032 Seite I 9
--------------------------	--------------------------	---	-----	---------	-----------	--------	-----	------------	-----------------------------

<input type="checkbox"/>	<input type="checkbox"/>		VHM	Z Cut	DIN 6527L	UT 45°	z:3	DIN 6535HA	757 032 Seite I 9
--------------------------	--------------------------	---	-----	-------	-----------	--------	-----	------------	-----------------------------

<input type="checkbox"/>	<input type="checkbox"/>		VHM	poliert	UT 37/40	z:3	DIN 6535HA	ER Torus	751 150 Seite I 10
--------------------------	--------------------------	---	-----	---------	----------	-----	------------	----------	------------------------------

<input type="checkbox"/>	<input type="checkbox"/>		VHM	poliert	UT 37/40	z:3	DIN 6535HA	L lang ER Torus	751 151 Seite I 10
--------------------------	--------------------------	---	-----	---------	----------	-----	------------	-----------------	------------------------------

● ●		VHM	poliert	HPC-W 40°	z:3	DIN 6535HA	751 653 Seite 11
● ●		VHM	poliert	HPC WR	z:3	DIN 6535HA	751 683 Seite 11

Schaftfräser VHM mit 2 und 3 Schneiden

Carbide End Mills with 2 or 3 flutes





Art.No./Page

● ●		VHM	poliert	W 30°	z:2	DIN 6535HA	751 023 Seite 12
● ●		VHM	poliert	W 40°	z:2	DIN 6535HA	751 020 Seite 12
● ●		VHM	poliert	W 0°	z:2	DIN 6535HA	751 000 Seite 13
● ●		VHM	poliert	W 30°	z:2	DIN 6535HA	751 040 Seite 13
● ●		VHM	poliert	W +30 -30	z:2	DIN 6535HA	751 027 Seite 14
● ●		VHM	poliert	UT 30°	z:3	DIN 6535HA	751 030 Seite 15
● ●		VHM	poliert	W 0°	z:3	DIN 6535HA	751 010 Seite 15
● ●		VHM	poliert	W 30°	z:3	DIN 6535HA	751 050 Seite 16
● ●		VHM	poliert	W 20°	z:3	DIN 6535HA	751 031 Seite 16
● ●		VHM	poliert	W 30°	z:3	DIN 6535HA	751 034 Seite 17
● ●		VHM	poliert	W 30°	z:3	DIN 6535HA	751 035 Seite 17

Fräser für spezielle Anwendungen

Carbide End Mills for Special Applications

Art.No./Page

●		VHM	poliert	AFRP 0°	z:2 1+1	DIN 6535HA	751 190 Seite 18
●		VHM	poliert	AFRP 0°	z:4 2+2	DIN 6535HA	751 194 Seite 18
● ●		VHM	poliert	W 20°	90°	z:2 DIN 6535HA	751 902 Seite 19
● ●		VHM	poliert	W 0°	90°	z: 2-4 DIN 6535HA	751 900 Seite 19

Fräser - Waben-Verbundwerkstoffe

Carbide End Mills for Honeycomb

Art.No./Page

○ ● ●		VHM	poliert	W 50°	z: multi	DIN 6535HA	751 077 Seite 20
-------	---	-----	---------	----------	-------------	---------------	------------------------------

				VHM	poliert	Set modulR	z: multi	DIN 6535HA	Honey Comb	751 078 Seite 20
--	--	--	--	-----	---------	------------	----------	------------	------------	------------------------------

				Teile parts	Honey Comb					751 079 Seite 21
--	--	--	--	-------------	------------	--	--	--	--	------------------------------

Fräser - Faser-Verbundwerkstoffe

Carbide End Mills for FRP

Art.No./Page

		VHM	DIA Plus	W +20 -20	Multi	DIN 6535HA	GFK CFK	791 060 Seite 22
--	--	-----	----------	-----------	-------	------------	---------	------------------------------

		VHM	DIA Aero	WX 0°	Multi	DIN 6535HA	CFK carbone	791 067 Seite 22
--	--	-----	----------	-------	-------	------------	-------------	------------------------------

		VHM	DIA Aero	WX -30°	Multi	DIN 6535HA	CFK carbone	791 069 Seite 23
--	--	-----	----------	---------	-------	------------	-------------	------------------------------

		VHM	DIA Aero	WX 30°		DIN 6535HA	CFK carbone	791 065 Seite 23
--	--	-----	----------	--------	--	------------	-------------	------------------------------

		VHM	Dia HC	W +20 -20	Multi	DIN 6535HA	GFK CFK	751 060 HC Seite 24
--	--	-----	--------	-----------	-------	------------	---------	---------------------------------

			VHM	poliert	W 0°	z:5	DIN 6535HA	GFK CFK	751 065 Seite 25
--	--	--	-----	---------	------	-----	------------	---------	------------------------------

		VHM	Dia HC	W 0°	z:5	DIN 6535HA	GFK CFK	751 065 HC Seite 25
--	--	-----	--------	------	-----	------------	---------	---------------------------------

			VHM	poliert	W 10°	z:6	DIN 6535HA	GFK CFK	751 066 Seite 26
--	--	--	-----	---------	-------	-----	------------	---------	------------------------------

		VHM	Dia HC	W 10°	z:6	DIN 6535HA	GFK CFK	751 066 HC Seite 26
--	--	-----	--------	-------	-----	------------	---------	---------------------------------

Pyramidverzahnte Fräser VHM

Carbide Pyramide Cut End Mills

Art.No./Page

		VHM	Dia HC	WX 30°	Multi	DIN 6535HA	GFK CFK	751 080 HC Seite 27
--	--	-----	--------	--------	-------	------------	---------	---------------------------------

		VHM	poliert	WX 30°	Multi	DIN 6535HA	GFK CFK	751 080 Seite 28
--	--	-----	---------	--------	-------	------------	---------	------------------------------

		VHM	Dia HC	WX 30°	Multi	DIN 6535HA	GFK CFK	751 070 HC Seite 29
--	--	-----	--------	--------	-------	------------	---------	---------------------------------

		VHM	poliert	WX 30°	Multi	DIN 6535HA	GFK CFK	751 070 Seite 30
--	--	-----	---------	--------	-------	------------	---------	------------------------------

		VHM	Dia HC	WX 30°	Multi	DIN 6535HA	GFK CFK	751 090 HC Seite 31
--	--	-----	--------	--------	-------	------------	---------	---------------------------------

		VHM	poliert	WX 30°	Multi	DIN 6535HA	GFK CFK	751 090 Seite 32
--	--	-----	---------	--------	-------	------------	---------	------------------------------





		VHM	Dia HC	WX 30°	Multi	DIN 6535HA	GFK CFK	751 085 HC Seite 33
--	--	-----	--------	--------	-------	------------	---------	---------------------------------

		VHM	poliert	WX 30°	Multi	DIN 6535HA	GFK CFK	751 085 Seite 34
--	--	-----	---------	--------	-------	------------	---------	------------------------------

Fräser - Grafitwerkstoffe

Carbide End Mills for Graphite









Art.No./Page

		VHM	DIA Graph	z:2	DIN 6535HA	L lang	Grafit	792 644 Seite 35
		VHM	DIA Graph	z:2	DIN 6535HA	L lang	Grafit	792 645 Seite 35

Fräser für Leichtlegierungen HSS-E

HSS-E End Mills for NF-Metals

Art.No./Page

			HSS E05	blank	Typ W	z:1	Shaft 8mm	551 100 Seite 36
			HSS E08	blank	DIN 844K	Typ W	z: 3 DIN 1835B	552 480 Seite 37
			HSS E08	blank	DIN 844L	Typ W	z:3 DIN 1835B	552 580 Seite 37

— INFO —

PKD (Polykristalliner Diamant)

PKD ist aufgrund seiner hohen Härte und Abrasionsbeständigkeit besonders geeignet als Schneidstoff zum Zerspanen von Holz-, Kunststoffen und NE-Metallen. Hier kann PKD seine Vorteile ausspielen:

- Extrem lange Standzeiten auch in abrasiven Werkstoffen
- Hohe Schnittgeschwindigkeiten und Vorschübe
- Endbearbeitung mit besten Oberflächengüten und Genauigkeiten

Der Einsatz von PKD setzt besonders steife und stabile Werkzeugmaschinen und Aufspannungen voraus. Zudem muss die Bearbeitungstemperatur unter 600 °C bleiben.

Unsere PKD-Werkzeugen sind Sonderlösungen, die speziell auf die kundenspezifischen Bedürfnisse ausgelegt sind. Lieferbar sind Bohrer, Fräser und Reibahlen in verschiedensten Geometrien.

PCD (Polycrystalline Diamond)

Due to its high hardness and abrasion resistance, PCD is particularly suitable as a cutting material for machining wood, plastics and non-ferrous metals. This is where PCD can bring its advantages to bear:

- Extremely long tool life even in abrasive materials
- High cutting speeds and feed rates
- Finishing with best surface qualities and accuracies

The use of PCD requires particularly rigid and stable machine tools and clamping systems. In addition, the machining temperature must remain below 600 °C.

Our PCD tools are special solutions, designed to meet customer-specific requirements. Drills, milling cutters and reamers in a wide variety of geometries are available.





- Für Leichtlegierung und Kunststoff
- Kurze, stabile Ausführung
- Schneidenlänge 3xØ
- Verstärkter Zylinderschaft Form HA
- Zentrumschnitt 1 Schneide über Mitte
- Oberfläche poliert

- For all light alloys and plastics
- Short series with high rigidity
- Cutting length 3xØ
- Reinforced cylindrical shank form HA
- Center cutting
- Polished finish

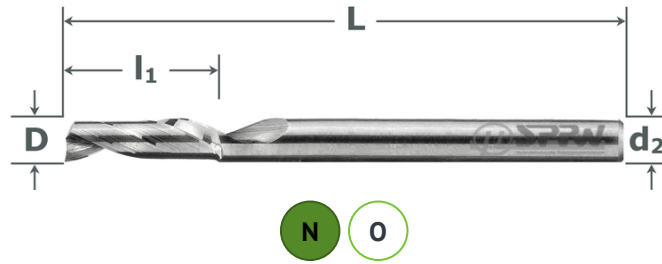

VHM	poliert
z:1	DIN 6535HA
micro 2-3xØ	sharp

ØD h10	Ød2 h5	L	l1	z	Art. No.
0,5	3	39	1,5	1	6685150050
0,6	3	39	1,5	1	6685150060
0,8	3	39	2	1	6685150080
1	3	39	3	1	6685150100
1,2	3	39	4	1	6685150120
1,4	3	39	4	1	6685150140

ØD h10	Ød2 h5	L	l1	z	Art. No.
1,5	3	39	4	1	6685150150
1,6	3	39	4	1	6685150160
1,8	3	39	5	1	6685150180
2	3	39	5	1	6685150200
2,5	3	39	7	1	6685150250
3	3	39	10	1	6685150300

INFO

Microfräser ab Ø0,05 mm in 1/10 steigend im Kapitel H "Micro Fräsen"

- Schneidenlängen 0,75xØ - 1,5xØ - 3xØ - 5xØ - 8xØ
- Nutzlängen mit Freistellung bis 30 mm
- Nutfräser, Radiusfräser und Torusfräser

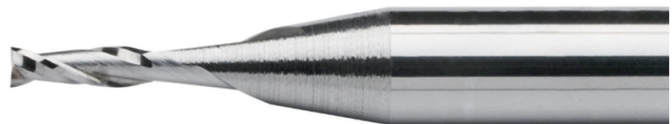

Micro End Mills from Ø0,05mm in 1/10 increments in chapter H "Micro Milling"

- Cutting lengths 0,75xØ - 1,5xØ - 3xØ - 5xØ - 8xØ
- Extended usable lengths up to 30 mm
- Flat nose, ball nose or corner radius

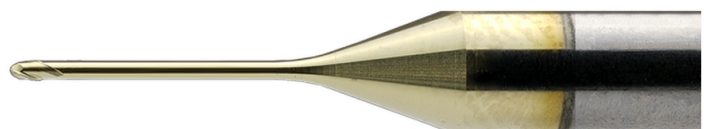

750 074**HSC-Einzahnfräser VHM HAWK**
Carbide HSC Single Flute End Mills HAWK

- Zur Bearbeitung von Alu-Profilen
- Spezielle Schneide zum Eintauchen
- Extrem scharfe Schneidkanten
- Rechtsschneidend mit Rechtsspirale
- Oberfläche poliert

- For working aluminum profiles
- Relieved cutting edges for diving
- Extremely sharp cutting edges
- Right hand helix, right hand cutting
- Polished finish

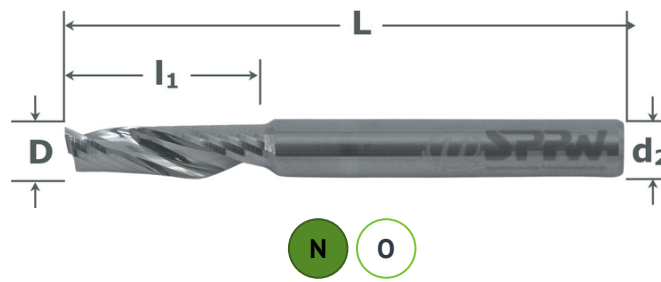

VHM	poliert
W 30°	z:1
DIN 6535HA	HAWK

ØD h10	Ød2 h6	L	l1	z	Art. No.
3	3	38	10	1	7500740300
4	4	50	12	1	7500740400
5	5	50	16	1	7500740500
5	5	50	11	1	7500740511
6	6	57	20	1	7500740600

ØD h10	Ød2 h6	L	l1	z	Art. No.
6	6	50	11	1	7500740611
8	8	63	24	1	7500740800
8	8	57	15	1	7500740815
10	10	72	30	1	7500741000

750 074 HC**HSC-Einzahnfräser VHM+Dia.HC HAWK**
Carbide HSC Single Flute End Mills+Dia.HC HAWK

- Zur Bearbeitung von Alu-Profilen
- Spezielle Schneide zum Eintauchen
- Extrem scharfe Schneidkanten
- Rechtsschneidend mit Rechtsspirale
- Oberfläche Dia.HC beschichtet

- For working aluminum profiles
- Relieved cutting edges for diving
- Extremely sharp cutting edges
- Right hand helix, right hand cutting
- With Dia.HC coating

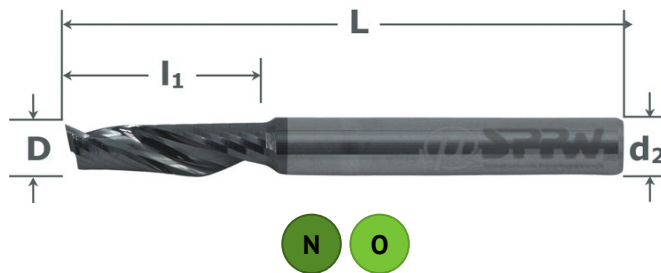

VHM	Dia HC
W 30°	z:1
DIN 6535HA	HAWK

ØD h10	Ød2 h6	L	l1	z	Art. No.
3	3	38	10	1	7500740300HC
4	4	50	12	1	7500740400HC
5	5	50	16	1	7500740500HC
5	5	50	11	1	7500740511HC
6	6	57	20	1	7500740600HC

ØD h10	Ød2 h6	L	l1	z	Art. No.
6	6	50	11	1	7500740611HC
8	8	63	24	1	7500740800HC
8	8	57	15	1	7500740815HC
8	10	72	30	1	7500741000HC

— INFO**Hawk (Habichtsnabel)**

Hawk-Einzahnfräser zeichnen sich durch eine sehr scharfe, freigeschliffene Stirnschneide aus und eignen sich aufgrund dieses Freischliffs besonders zum Bohren und anschließendem Besäumen von Aluminium-Vollmaterial und Profilen. Sie sind auch mit Dia.HC Beschichtung erhältlich.

Hawk (Beak)

Hawk single flute cutters have a very sharp, relief-ground frontal cutting edge. They are particularly suitable for drilling and subsequent trimming in aluminum material. They are also available with Dia.HC coating for longer tool life and improved vibration characteristics.

751 100

HSC-Einzahnfräser VHM Rechtsdrall

Carbide HSC Single Flute End Mills Right Hand Helix



- Leichtlegierungen und Kunststoffe
- Rechtsschneidend mit Rechtsspirale
- Zentrumschnitt zum Tauchen
- Extrem scharfe Schneidkanten
- Oberfläche poliert

- Light alloys and plastics
- Right hand helix, right hand cutting
- Center cutting for plunging
- Extremely sharp cutting edges
- Polished finish

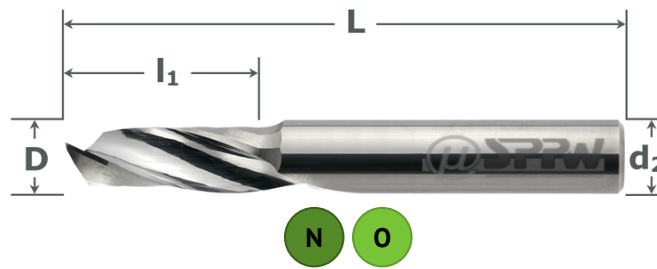

ØD h10	Ød2 h6	L	l1	z	Art. No.
2	2	40	10	1	7511000200
3	3	40	12	1	7511000300
3	6	60	15	1	7511000300L
4	4	40	15	1	7511000400
4	6	75	20	1	7511000400L
5	5	50	16	1	7511000500
5	6	75	28	1	7511000500L
6	6	60	20	1	7511000600
6	6	75	35	1	7511000600L

ØD h10	Ød2 h6	L	l1	z	Art. No.
8	8	63	22	1	7511000800
8	8	100	45	1	7511000800L
10	10	72	25	1	7511001000
10	10	100	55	1	7511001000L
12	12	83	30	1	7511001200
14	14	83	30	1	7511001400
16	16	92	35	1	7511001600
20	20	104	40	1	7511002000

Schaft 6 h6 - shank 6 mm

ØD h10	Ød2 h6	L	l1	z	Art. No.
1	6	50	4	1	751100S010601
2	6	50	6	1	751100S020601
2	6	50	20	1	751100S020602
3	6	50	11	1	751100S030601
3	6	50	22	1	751100S030602

ØD h10	Ød2 h6	L	l1	z	Art. No.
4	6	50	14	1	751100S040601
4	6	50	22	1	751100S040602
5	6	50	22	1	751100S050601
6	6	50	22	1	751100S060601
8	6	75	32	1	751100S080601



- Leichtlegierungen und Kunststoffe
- Rechtsschneidend mit Linksspirale
- Spanauswurf nach unten
- Extrem scharfe Schneidkanten
- Oberfläche poliert
- Light alloys and plastics
- Left hand helix, right hand cutting
- Extremely sharp cutting edges
- Down-Cut
- Polished finish

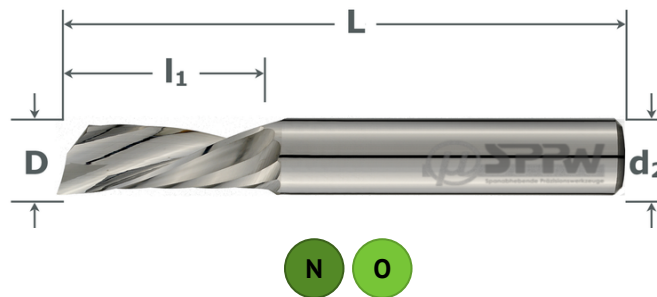

ØD h10	Ød2 h6	L	l1	z	Art. No.
2	2	40	10	1	7511100200
3	3	40	12	1	7511100300
4	4	40	15	1	7511100400
5	5	50	16	1	7511100500
6	6	60	20	1	7511100600
8	8	63	22	1	7511100800

ØD h10	Ød2 h6	L	l1	z	Art. No.
10	10	72	25	1	7511101000
12	12	83	30	1	7511101200
14	14	83	30	1	7511101400
16	16	92	35	1	7511101600
20	20	104	40	1	7511102000

Schaft 6 h6 - shank 6 mm

ØD h10	Ød2 h6	L	l1	z	Art. No.
1	6	50	4	1	751110S010601
2	6	50	6	1	751110S020601
2	6	50	20	1	751110S020602
3	6	50	11	1	751110S030601
3	6	50	22	1	751110S030602

ØD h10	Ød2 h6	L	l1	z	Art. No.
4	6	50	14	1	751110S040601
4	6	50	22	1	751110S040602
5	6	50	22	1	751110S050601
6	6	50	22	1	751110S060601
8	6	75	32	1	751110S060801

— INFO —



Linksspirale vs. Rechtsspirale (Linksdraht der Spannut - Fräser Rechtsschneidend)

Bei einer Linksspirale werden die Späne nach unten in Richtung Werkstück abgeführt. Daher wird das Werkstück bei der Bearbeitung angedrückt, was speziell bei Aufspannungen mit geringer Haltekraft positiv ist. Bei der Bearbeitung von Werkstücken, die zum Ausreißen neigen, lassen sich bessere Oberflächen erzielen. Allerdings ist der Materialabtrag pro Durchgang geringer als bei Fräsern mit Rechtsspirale.

Left-Hand Helix vs. Right-Hand Helix (left-hand twist of the flute - cutter right-hand cutting)

With a left-hand helix, the chips are discharged downwards in the direction of the workpiece. The workpiece is pressed down during machining, which is especially positive for setups with low holding force. Better surfaces can be achieved when machining workpieces that tend to tear out. However, the material removal per pass is lower than with right-hand helix milling cutters.

751 001

HSC-Konturfräser VHM 1 Schneide Geradegenutet Carbide HSC Contouring End Mills 1 Flute Straight Flute



- Leichtlegierungen, Kunststoffe
- Blech, Platten, dünnwandiges Material
- Gerade genutet mit Zentrumschnitt
- Keine Zugkräfte am Werkstück
- Großer Spanraum, leichte Spanabfuhr
- Oberfläche poliert

- Light alloys, plastic, thin materials
- Straight flutes center cutting
- No drag or push on the workpiece
- Large chip space, easy chip removal
- Polished finish

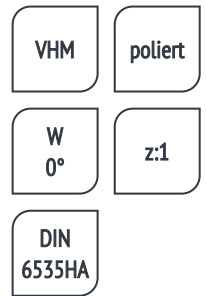
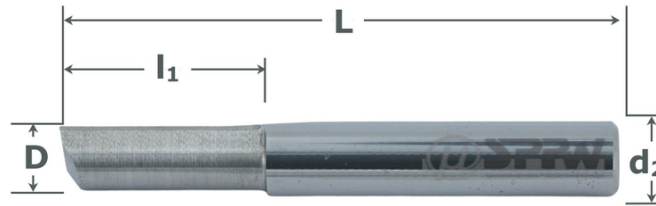

ØD h10	Ød2 h6	L	l1	z	Art. No.
1,5	3	40	6	1	7510010156
2	3	40	6	1	7510010203
2	6	60	10	1	7510010206L
3	3	40	12	1	7510010300
3	6	60	15	1	7510010306L
4	6	60	15	1	7510010406
4	6	75	20	1	7510010406L
5	6	60	16	1	7510010506

ØD h10	Ød2 h6	L	l1	z	Art. No.
6	6	60	20	1	7510010600
6	6	75	35	1	7510010600L
8	8	63	22	1	7510010800
8	8	100	40	1	7510010800L
10	10	72	25	1	7510011000
10	10	100	55	1	7510011000L
12	12	83	30	1	7510011200

751 105

HSC-Radius-Einzahnfräser VHM Carbide HSC Single Flute Radius End Mills



- Leichtlegierungen und Kunststoffe
- Rechtsschneidend mit Rechtsspirale
- Stirnradius für Kopierarbeiten
- Extrem scharfe Schneidkanten
- Oberfläche poliert

- Light alloys and plastics
- Right hand helix, right hand cutting
- Radius for copying operations
- Extremely sharp cutting edges
- Polished finish

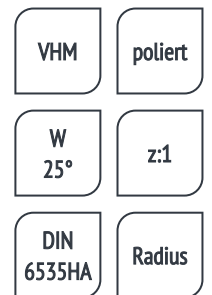
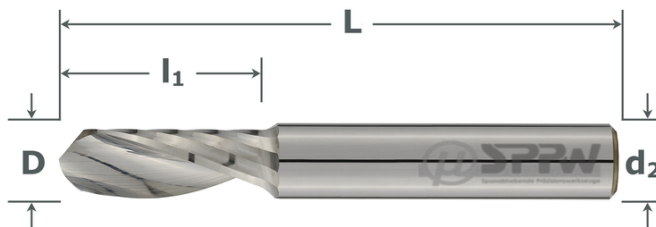

ØD h10	Ød2 h6	L	l1	z	Art. No.
2	3	40	6	1	7511050203
2	6	60	10	1	7511050206
3	3	40	12	1	7511050300
3	6	60	12	1	7511050306
4	4	40	15	1	7511050400
4	6	60	15	1	7511050406
5	5	50	16	1	7511050500
5	6	60	16	1	7511050506

ØD h10	Ød2 h6	L	l1	z	Art. No.
6	6	60	20	1	7511050600
6	6	75	35	1	7511050601
8	8	63	22	1	7511050800
8	8	100	40	1	7511050801
10	10	72	25	1	7511051000
10	10	100	55	1	7511051001
12	12	83	30	1	7511051200



- Für hochtransparente Oberflächen
- Acryl, Plexiglas, Polykarbonat
- Extrem scharfe Schneidkanten
- Oberfläche poliert
- For highly transparent surfaces
- Acrylic, PMMA, polycarbonate
- Extremely sharp cutting edges
- Polished finish

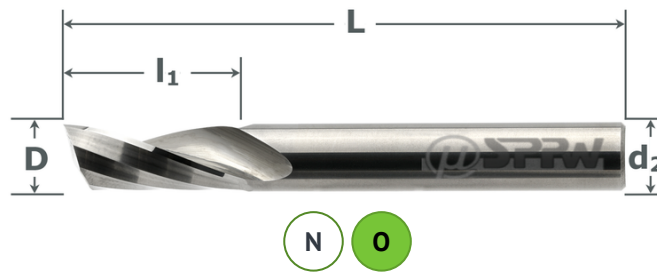

VHM	poliert
W 24°	z:1
DIN 6535HA	PLX

750033 - kurz | short version

ØD h10	Ød2 h6	L	l1	z	Art. No.
3	3	38	8	1	7500330300
4	4	50	10	1	7500330400
5	5	50	12	1	7500330500
6	6	57	16	1	7500330600

ØD h10	Ød2 h6	L	l1	z	Art. No.
8	8	63	20	1	7500330800
10	10	72	24	1	7500331001
12	12	83	28	1	7500331201

750035 - mittel | medium version

ØD h10	Ød2 h6	L	l1	z	Art. No.
2	2	38	8	1	7500350200
3	3	38	12	1	7500350300
4	4	50	14	1	7500350400
5	5	60	18	1	7500350500

ØD h10	Ød2 h6	L	l1	z	Art. No.
6	6	60	22	1	7500350600
8	8	75	32	1	7500350800
10	10	75	35	1	7500351001
12	12	83	40	1	7500351201

750037 - lang | long version

ØD h10	Ød2 h6	L	l1	z	Art. No.
3	3	50	16	1	7500370300
4	4	60	18	1	7500370400
5	5	60	25	1	7500370500

ØD h10	Ød2 h6	L	l1	z	Art. No.
6	6	75	32	1	7500370600
8	8	80	42	1	7500370800

INFO

Fräser für hochtransparente Oberflächen

PLX-Shine-Fräser sind speziell zur Bearbeitung von transparenten Kunststoffen (Acryl) ausgelegt. Durch die "ultrageläppte" Spannutt, die besondere Geometrie und die geläpften Schneidkanten weisen PLX-Shine Fräser herausragende Eigenschaften auf.

- Spezielle Kantenpräparation = optimierte Spanbildung
- Polierte Spannuten = bessere Spanabfuhr

Hochtransparente Fräsoberflächen, nachträgliches Polieren kann entfallen.

Milling Cutters for Highly Transparent Surfaces

PLX-Shine cutters are specially designed for machining transparent plastics (e.g. acrylic). Due to the "ultra-polished" flute, the special cutting geometry and the honed cutting edges, PLX-Shine cutters have outstanding machining properties.

- Special edge preparation = optimized chipping
- Polished flutes = improved chip evacuation

The milled surfaces are highly transparent, no subsequent polishing required.



751 024

HSC-Torusfräser VHM 2 Schneiden
Carbide Torical HSC End Mills 2 Flutes



- HSC-Schrupp-/Schlichtfräser
- Langspanende Werkstoffe, NE-Metalle
- 40° Spirale mit großen Spanräumen
- Freistellung nach der Schneide
- Oberfläche poliert
- HSC roughing and finishing
- Long chipping materials, NF-metals
- 40° helix with large chip space
- Back clearance after cutting edge
- Polished finish

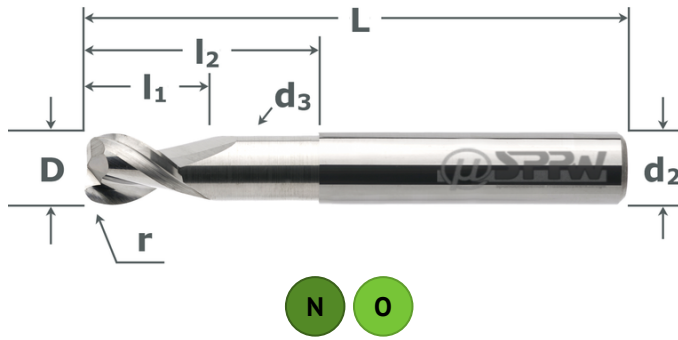

VHM	poliert
W 40°	z:2
DIN 6535HA	ER Torus

ØD h10	Ød2 h6	L	l1	l2	z	r Radius	Ød3	Art. No.
2	6	57	4	6	2	0,5	1,8	7510240205
3	6	57	5	9	2	0,5	2,8	7510240305
3	6	100	6	50	2	0,5	2,8	7510240305L
4	6	57	6	12	2	0,5	3,7	7510240405
4	6	100	8	50	2	0,5	3,7	7510240405L
5	6	57	7	15	2	0,5	4,6	7510240505
5	6	100	10	50	2	0,5	4,6	7510240505L
6	6	57	8	20	2	1	5,5	7510240610
6	6	100	12	50	2	1	5,5	7510240610L
8	8	63	10	26	2	1	7,4	7510240810
8	8	100	16	50	2	1	7,4	7510240810L

ØD h10	Ød2 h6	L	l1	l2	z	r Radius	Ød3	Art. No.
10	10	72	12	31	2	1,5	9,2	7510241015
10	10	120	20	70	2	1,5	9,2	7510241015L
12	12	83	14	37	2	1,5	11	7510241215
12	12	150	24	100	2	1,5	11	7510241215L
14	14	83	16	41	2	2	13	7510241420
14	14	150	28	100	2	2	13	7510241420L
16	16	92	18	43	2	2	15	7510241620
16	16	150	32	100	2	2	15	7510241620L
20	20	150	40	100	2	2,5	19	7510242000L
20	20	104	22	53	2	2,5	19	7510242025

Alu.Cut Beschichtung | coating

ØD h10	Ød2 h6	L	l1	l2	z	r Radius	Ød3	Art. No.
2	6	57	4	6	2	0,5	1,8	7510240205A
3	6	57	5	9	2	0,5	2,8	7510240305A
3	6	100	6	50	2	0,5	2,8	7510240305LA
4	6	57	6	12	2	0,5	3,7	7510240405A
4	6	100	8	50	2	0,5	3,7	7510240405LA
5	6	57	7	15	2	0,5	4,6	7510240505A
5	6	100	10	50	2	0,5	4,6	7510240505LA
6	6	57	8	20	2	1	5,5	7510240610A
6	6	100	12	50	2	1	5,5	7510240610LA
8	8	63	10	26	2	1	7,4	7510240810A
8	8	100	16	50	2	1	7,4	7510240810LA

ØD h10	Ød2 h6	L	l1	l2	z	r Radius	Ød3	Art. No.
10	10	72	12	31	2	1,5	9,2	7510241015A
10	10	120	20	70	2	1,5	9,2	7510241015LA
12	12	83	14	37	2	1,5	11	7510241215A
12	12	150	24	100	2	1,5	11	7510241215LA
14	14	83	16	41	2	2	13	7510241420A
14	14	150	28	100	2	2	13	7510241420LA
16	16	92	18	43	2	2	15	7510241620A
16	16	150	32	100	2	2	15	7510241620LA
20	20	150	40	100	2	2,5	19	7510242000LA
20	20	104	22	53	2	2,5	19	7510242025A

751 025

HSC-Radiusfräser VHM 2 Schneiden
Carbide HSC Radius End Mills 2 Flutes



- HSC-Schrupp-/Schlichtfräser
- Langspanende Werkstoffe, NE-Metalle
- 40° Spirale mit großen Spanräumen
- Freistellung nach der Schneide
- Oberfläche poliert
- HSC roughing and finishing
- Long chipping materials, NF-metals
- 40° helix with large chip space
- Back clearance after cutting edge
- Polished finish

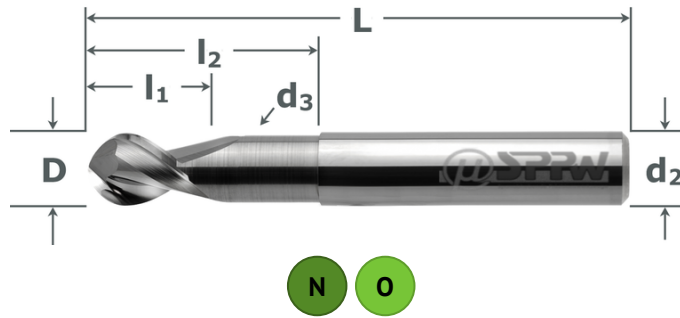

VHM	poliert
W 40°	z:2
DIN 6535HA	Radius

ØD h10	Ød2 h6	L	l1	l2	z	Ød3	Art. No.
2	6	57	4	6	2	1,8	7510250200
3	6	57	5	9	2	2,8	7510250300
3	6	100	6	50	2	2,8	7510250300L
4	6	57	6	12	2	3,7	7510250400
4	6	100	8	50	2	3,7	7510250400L
5	6	57	7	15	2	4,6	7510250500
5	6	100	10	50	2	4,6	7510250500L
6	6	57	8	20	2	5,5	7510250600
6	6	100	12	50	2	5,5	7510250600L
8	8	63	10	26	2	7,4	7510250800
8	8	100	16	50	2	7,4	7510250800L

ØD h10	Ød2 h6	L	l1	l2	z	Ød3	Art. No.
10	10	72	12	31	2	9,2	7510251000
10	10	120	20	70	2	9,2	7510251000L
12	12	83	14	37	2	11	7510251200
12	12	150	24	100	2	11	7510251200L
14	14	83	16	41	2	13	7510251400
14	14	150	28	100	2	13	7510251400L
16	16	92	18	43	2	15	7510251600
16	16	150	32	100	2	15	7510251600L
20	20	104	22	53	2	19	7510252000
20	20	150	40	100	2	19	7510252000L

Alu.Cut Beschichtung | coating

ØD h10	Ød2 h6	L	l1	l2	z	Ød3	Art. No.
2	6	57	4	6	2	1,8	7510250200A
3	6	57	5	9	2	2,8	7510250300A
3	6	100	6	50	2	2,8	7510250300LA
4	6	57	6	12	2	3,7	7510250400A
4	6	100	8	50	2	3,7	7510250400LA
5	6	57	7	15	2	4,6	7510250500A
5	6	100	10	50	2	4,6	7510250500LA
6	6	57	8	20	2	5,5	7510250600A
6	6	100	12	50	2	5,5	7510250600LA
8	8	63	10	26	2	7,4	7510250800A
8	8	100	16	50	2	7,4	7510250800LA

ØD h10	Ød2 h6	L	l1	l2	z	Ød3	Art. No.
10	10	72	12	31	2	9,2	7510251000A
10	10	120	20	70	2	9,2	7510251000LA
12	12	83	14	37	2	11	7510251200A
12	12	150	24	100	2	11	7510251200LA
14	14	83	16	41	2	13	7510251400A
14	14	150	28	100	2	13	7510251400LA
16	16	92	18	43	2	15	7510251600A
16	16	150	32	100	2	15	7510251600LA
20	20	104	22	53	2	19	7510252000A
20	20	150	40	100	2	19	7510252000LA

— INFO



Kleinstfräser für den Aluminium-Formenbau im Kapitel H " Micro Fräsen"

- Nutfräser
- Torusfräser
- Radiusfräser

Miniature End Mills for Aluminium Moldmaking in chapter H "Micro Milling"

- Slot end mills
- Torical end mills
- Radius end mills

751 032

Hochleistungsfräser VHM 3 Schneiden ungleiche Teilung
Carbide High Performance End Mills 3 Flutes Unequal Helix



- Schruppen und Schlichten
- Langspanende Werkstoffe, NE-Metalle
- 45° Spirale, ungleiche Stirnteilung
- Schutzfase an den Schneidecken
- Oberfläche poliert
- Roughing and finishing operations
- Long chipping materials, NF-metals
- 45° helix with unequal spacing
- Protective chamfers on edges
- Polished finish

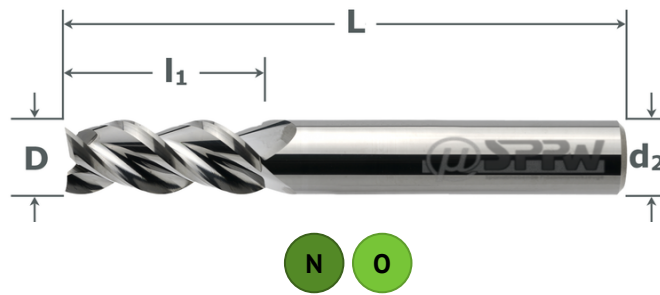

VHM	poliert
DIN 6527L	UT 45°
z:3	DIN 6535HA

ØD h10	Ød2 h6	L	l1	z	Art. No.
3	6	57	10	3	7510320300
4	6	57	13	3	7510320400
5	6	57	15	3	7510320500
6	6	57	18	3	7510320600
7	8	63	20	3	7510320700
8	8	63	20	3	7510320800
9	10	72	22	3	7510320900

ØD h10	Ød2 h6	L	l1	z	Art. No.
10	10	72	25	3	7510321000
12	12	83	30	3	7510321200
14	14	83	30	3	7510321400
16	16	92	35	3	7510321600
18	18	92	35	3	7510321800
20	20	104	45	3	7510322000

757 032

Hochleistungsfräser VHM+Z.Cut ungleiche Teilung
Carbide High Performance End Mills+Z.Cut Unequal Helix



- HPC-Schrupp- und Schlichtfräser
- Langspanende Werkstoffe, NE-Metalle
- Ungleiche Teilung und Schutzfasen
- Freistellung nach der Schneide
- Z.Cut-beschichtet für höhere Leistung
- HPC roughing, finishing operations
- Long chipping materials, NF-materials
- Unequal helix, protective chamfers
- Back clearance after cutting edge
- Z.Cut coating for higher performance

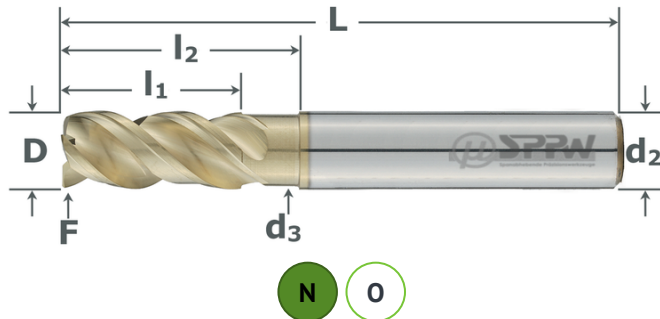

VHM	Z Cut
DIN 6527L	UT 45°
z:3	DIN 6535HA

ØD e8	Ød2 h5	L	l1	l2	z	F	Art. No.
6	6	57	13	21	3	0,2	7570320600
8	8	63	19	26	3	0,2	7570320800
10	10	72	22	30	3	0,25	7570321000

ØD e8	Ød2 h5	L	l1	l2	z	F	Art. No.
12	12	83	26	37	3	0,3	7570321200
16	16	92	32	42	3	0,4	7570321600
20	20	104	38	50	3	0,45	7570322000

— INFO —

TDC - Trochoidal Dynamic Cutting

Hochdynamisches Fräsen mit hohen Schnittgeschwindigkeiten und kontrollierten Eingriffstiefen.
 CAM-optimierte Werkzeugwege + variable Zustellung + dynamische Vorschubgeschwindigkeiten
 => homogenen Spandicke und damit optimalen Schnittbedingungen bei der Fräsbearbeitung.

- Die volle Eingriffstiefe des Fräsers (3xØ) kann genutzt werden
- Die Schnittkräfte verteilen sich besser auf das Fräserswerkzeug
- Es entsteht deutlich weniger Hitze im Fräsprozess
- Das Zeitspanvolumen erhöht sich drastisch
- Die Bearbeitungszeiten verringern sich deutlich
- Die Lebensdauer des Fräserswerkzeugs wird erhöht

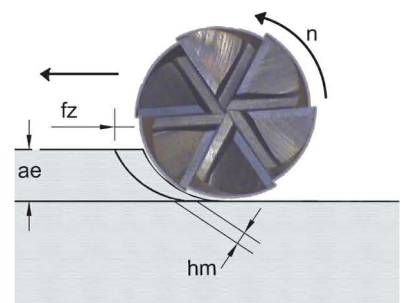



- Für Werkstoffe mit Klebeneigung
- TDC-/HPC-/3D-Fräsen im Formenbau
- Dünne Wandungen, tiefe Taschen
- Hohe Laufruhe, ungleiche Teilung
- Oberfläche poliert

- Long chipping materials, NF metals
- TDC/HPC/3D milling in toolmaking
- Deep pockets, small wall thickness
- Unequal helix allows smooth milling
- Polished finish

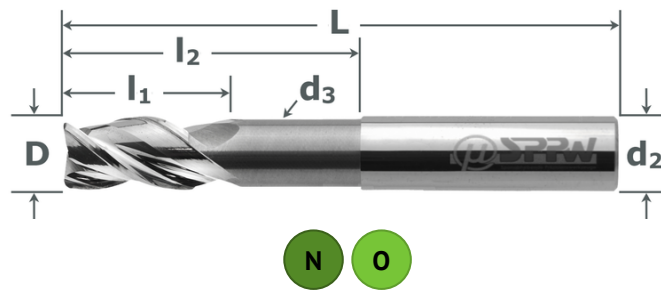

VHM	poliert
UT 37/40	z:3
DIN 6535HA	ER Torus

751150 - kurz | short version

ØD h9	Ød2 h6	L	l1	l2	z	r Radius	Ød3	Art. No.
4	4	50	6	22	3	0,2	3,6	7511500402
4	4	50	6	22	3	0,5	3,6	7511500405
5	5	50	7,5	22	3	0,2	4,5	7511500502
5	5	50	7,5	22	3	0,5	4,5	7511500505
6	6	57	9	21	3	0,3	5,5	7511500603
6	6	57	9	21	3	0,5	5,5	7511500605
6	6	57	9	21	3	1	5,5	7511500610
6	6	57	9	21	3	1,5	5,5	7511500615
8	8	63	12	27	3	0,3	7,4	7511500803
8	8	63	12	27	3	0,5	7,4	7511500805
8	8	63	12	27	3	1	7,4	7511500810
8	8	63	12	27	3	1,5	7,4	7511500815
10	10	72	15	32	3	0,3	9,2	7511501003

ØD h9	Ød2 h6	L	l1	l2	z	r Radius	Ød3	Art. No.
10	10	72	15	32	3	0,5	9,2	7511501005
10	10	72	15	32	3	1	9,2	7511501010
10	10	75	15	32	3	1,5	9,2	7511501015
12	12	83	18	38	3	0,3	11	7511501203
12	12	83	18	38	3	0,5	11	7511501205
12	12	83	18	38	3	1	11	7511501210
12	12	83	18	38	3	2	11	7511501220
16	16	92	24	44	3	0,5	15	7511501605
16	16	92	24	44	3	2	15	7511501620
16	16	92	24	44	3	3	15	7511501630
20	20	104	30	54	3	0,5	19	7511502005
20	20	104	30	54	3	2	19	7511502020
20	20	104	30	54	3	4	19	7511502040

751151 - lang | long version

ØD h9	Ød2 h6	L	l1	l2	z	r Radius	Ød3	Art. No.
6	6	80	9	44	3	0,3	5,5	7511510603
6	6	80	9	44	3	1	5,5	7511510610
8	8	100	12	64	3	0,3	7,4	7511510803
8	8	100	12	64	3	1	7,4	7511510810
10	10	125	15	85	3	0,3	9,2	7511511003
10	10	125	15	85	3	1	9,2	7511511010

ØD h9	Ød2 h6	L	l1	l2	z	r Radius	Ød3	Art. No.
12	12	125	18	80	3	0,3	11	7511511203
12	12	125	18	80	3	2	11	7511511220
16	16	150	24	102	3	0,5	15	7511511605
16	16	150	24	102	3	2	15	7511511620
20	20	150	30	102	3	0,5	19	7511512005
20	20	150	30	102	3	2	19	7511512020

— INFO —

TDC-/HPC- und 3D-Bearbeitung

- Herstellen tiefer Taschen mit geringsten Wandstärken
- Extrem scharfe Schneidkanten für leichten Schnitt
- Polierte Oberflächen für geringe Klebeneigung
- Ungleiche Teilung für extreme Laufruhe

TDC/HPC and 3D Milling

- Milling of slim walls and deep pockets
- Extremely sharp cutting edges, easy milling
- Polished surfaces, no material build up
- Smooth milling due to unequal helix



751 653

Hochleistungs-Fräser VHM Mit Spanbrecher Carbide High Performance End Mills With Chip Breaker



- TDC, HPC in langspanenden Material
- Optimierte Kanten, große Spannuten
- Spanbrecher Typ WF
- Schutzfase an den Schneidecken
- Oberfläche poliert

- Trochoidal in long chipping materials
- Optimized edges, deep flutes
- Chip breaker type WF
- Protective chamfers on cutting edge
- Polished finish

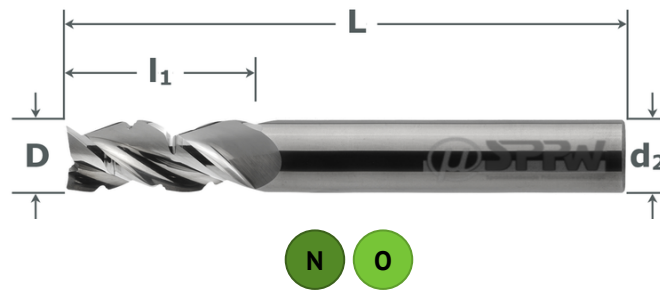

VHM	poliert
HPC-W 40°	z:3
DIN 6535HA	

ØD h10	Ød2 h6	L	l1	z	Art. No.
10	10	72	22	3	7516531000
12	12	83	26	3	7516531200

ØD h10	Ød2 h6	L	l1	z	Art. No.
16	16	92	32	3	7516531600
20	20	104	38	3	7516532000

751 683

Schruppfräser VHM Polierte Schneiden Carbide Roughing End Mills Polished Flutes



- Für langspanende Werkstoffe
- 35° Spirale mit großen Spanräumen
- Grobe Kordelverzahnung Typ WR
- Schutzfase an den Schneidecken
- Spannuten poliert
- Lieferzeit 3-5 Arbeitstage

- Roughing in long chipping material
- 35° helix with large flutes
- Roughing profile type WR
- Protective chamfers on edges
- Polished flutes
- Delivery time 3-5 work days

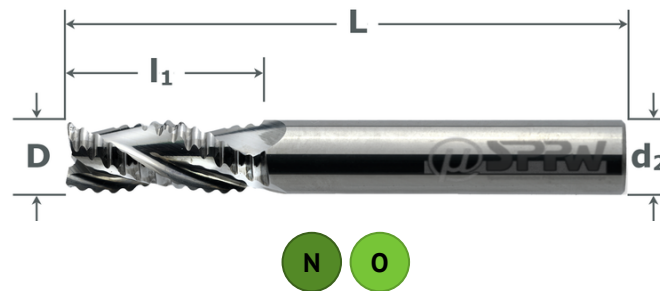

VHM	poliert
HPC WR	z:3
DIN 6535HA	

ØD h10	Ød2 h6	L	l1	z	Art. No.
8	8	63	19	3	7516830800
10	10	72	22	3	7516831000
12	12	83	26	3	7516831200

ØD h10	Ød2 h6	L	l1	z	Art. No.
16	16	92	32	3	7516831600
20	20	104	38	3	7516832000

INFO

Die Fräserfamilie für langspanende Werkstoffe mit Klebeneigung

- 3 Schneiden mit tiefen Spannuten für hohen Spanabtrag
- Extrem scharfe Schneidkanten für leichten Schnitt
- Polierte Oberflächen für geringe Klebeneigung
- Verschiedene Varianten, z.B. mit Spanbrechern

The Milling Cutter Family for Performance in Aluminium

- 3 flutes with deep grooves, excellent chip removal
- Extremely sharp cutting edges, easy milling
- Polished surfaces, no material build-up
- Different versions, e.g. with chip breakers

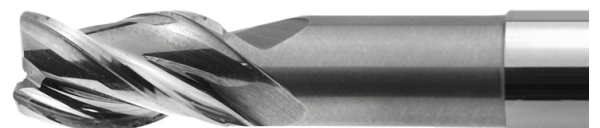

751 023

HSC-Schaftfräser VHM 2 Schneiden Carbide HSC End Mills 2 Flutes



- Leichtlegierungen und Kunststoffe
- Rechtsschneidend mit Rechtsspirale
- Zentrumschnitt zum Tauchen
- Extrem scharfe Schneidkanten
- Oberfläche poliert

- Light alloys and plastics
- Right hand helix, right hand cutting
- Center cutting for plunging
- Extremely sharp cutting edges
- Polished finish

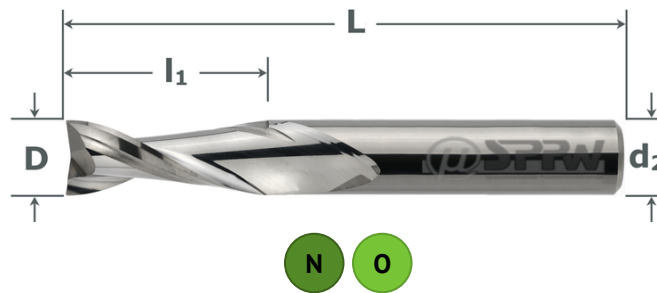

VHM	poliert
W 30°	z:2
DIN 6535HA	

ØD h10	Ød2 h6	L	l1	z	Art. No.
2	3	50	8	2	7510230203
3	3	40	12	2	7510230300
4	4	40	14	2	7510230400
5	5	50	16	2	7510230500
6	6	50	18	2	7510230600

ØD h10	Ød2 h6	L	l1	z	Art. No.
8	8	63	20	2	7510230800
10	10	72	25	2	7510231000
12	12	83	30	2	7510231200
16	16	92	35	2	7510231600
20	20	104	45	2	7510232000

Schaft 6 h6 - shank 6 mm

ØD h10	Ød2 h6	L	l1	z	Art. No.
1	6	50	4	2	751023S010601
2	6	50	6	2	751023S020601
2	6	50	20	2	751023S020602
3	6	50	11	2	751023S030601
3	6	50	22	2	751023S030602

ØD h10	Ød2 h6	L	l1	z	Art. No.
4	6	50	14	2	751023S040601
4	6	50	22	2	751023S040602
5	6	50	22	2	751023S050601
6	6	50	22	2	751023S060601
8	6	58	20	2	751023S080601

751 020

HSC-Schaftfräser VHM Überlang Carbide HSC End Mills Extra Long



- Leichtlegierungen und Kunststoffe
- Rechtsschneidend mit Rechtsspirale
- Zentrumschnitt zum Tauchen
- Extrem scharfe Schneidkanten
- Oberfläche poliert

- Light alloys and plastics
- Right hand helix, right hand cutting
- Center cutting for plunging
- Extremely sharp cutting edges
- Polished finish

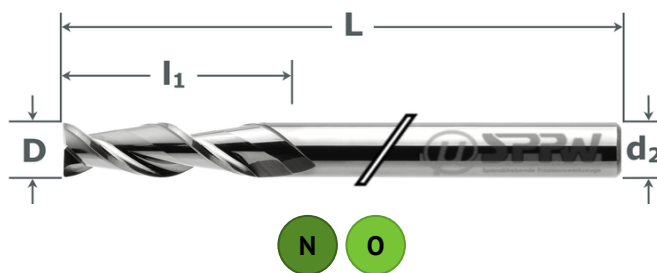

VHM	poliert
W 40°	z:2
DIN 6535HA	

ØD h10	Ød2 h6	L	l1	z	Art. No.
6	6	100	21	2	7510200610
8	8	100	28	2	7510200810
8	8	160	28	2	7510200816
10	10	100	35	2	7510201010
10	10	160	35	2	7510201016

ØD h10	Ød2 h6	L	l1	z	Art. No.
12	12	100	42	2	7510201210
12	12	160	42	2	7510201216
16	16	100	48	2	7510201610
16	16	160	56	2	7510201616

751 000

HSC-Konturfräser VHM 2 Schneiden Geradegenutet
Carbide HSC Contouring End Mills 2 Straight Flutes



- Leichtlegierungen, Kunststoffe
- Blech, Platten, dünnwandiges Material
- Gerade genutet mit Zentrumschnitt
- Keine Zugkräfte am Werkstück
- Oberfläche poliert
- Light alloy, plastic, thin materials
- Straight flutes center cutting
- No drag or push on the workpiece
- Polished finish

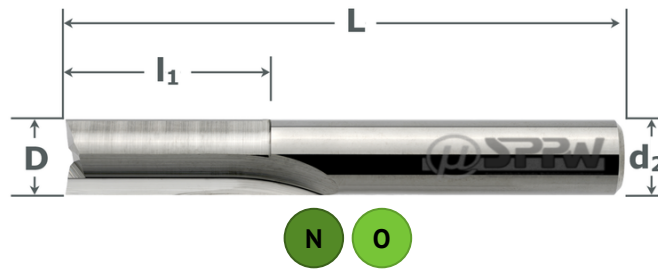

VHM	poliert
W 0°	z:2
DIN 6535HA	

ØD h10	Ød2 h6	L	l1	z	Art. No.
3	3	40	12	2	7510000300
4	4	40	14	2	7510000400
5	5	50	16	2	7510000500
6	6	50	18	2	7510000600
8	8	63	20	2	7510000800

ØD h10	Ød2 h6	L	l1	z	Art. No.
10	10	72	25	2	7510001000
12	12	83	30	2	7510001200
16	16	92	35	2	7510001600
20	20	104	45	2	7510002000

751 040

HSC-Schaftfräser VHM 2 Schneiden Linksdrall
Carbide HSC End Mills 2 Flutes Left Hand Helix



- Leichtlegierungen und Kunststoffe
- Rechtsschneidend mit Linksspirale
- Spanauswurf nach unten
- Extrem scharfe Schneidkanten
- Oberfläche poliert
- Light alloys and plastics
- Left hand helix, right hand cutting
- Extremely sharp cutting edges
- Down-Cut
- Polished finish

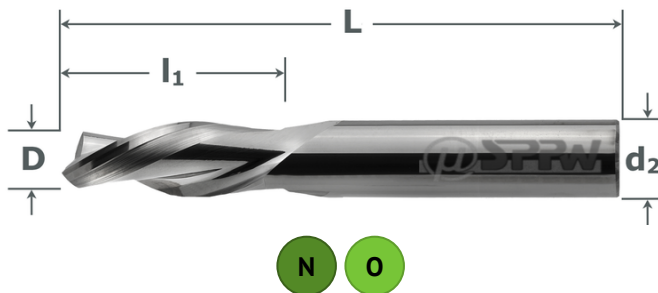

VHM	poliert
W 30°	z:2
DIN 6535HA	down cut

ØD h10	Ød2 h6	L	l1	z	Art. No.
2	6	50	6	2	7510400206
3	3	40	12	2	7510400300
3	6	50	12	2	7510400306
4	4	40	14	2	7510400400
5	5	50	16	2	7510400500
6	6	50	18	2	7510400600

ØD h10	Ød2 h6	L	l1	z	Art. No.
8	8	63	20	2	7510400800
10	10	72	25	2	7510401000
12	12	83	30	2	7510401200
16	16	92	35	2	7510401600
20	20	104	45	2	7510402000



- Faserkunststoff, NE-Legierung, Laminat
- Gegenläufigen Spannuten
- Simultan ziehend, schiebender Schnitt
- Gratfreie Kanten, keine Delamination
- Extrem scharfe Schneiden
- Oberfläche poliert
- FRP, NF-alloy, laminate
- Opposed helix
- Simultaneous dragging, compacting cut
- Burr free edges, no delamination
- Extremely sharp cutting edges
- Polished finish

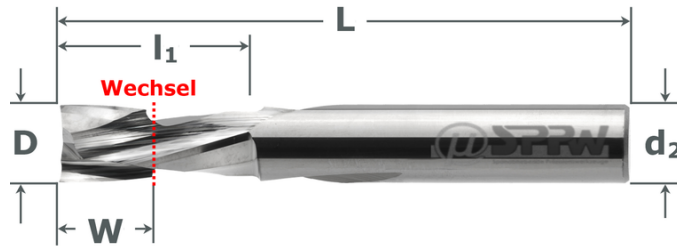

VHM	poliert
W +30l-30	z:2
DIN 6535HA	Butter Fly

ØD h10	Ød2 h6	L	l1	z	W	Art. No.
2	6	40	6	2	3	7510270200
3	3	40	12	2	3	7510270300
3	6	50	12	2	3	7510270306
4	4	40	14	2	4	7510270400
5	5	50	16	2	7	7510270500

ØD h10	Ød2 h6	L	l1	z	W	Art. No.
6	6	50	18	2	5	7510270600
8	8	63	20	2	7	7510270800
10	10	72	25	2	10	7510271000
12	12	83	30	2	11	7510271200

INFO

Butter-Fly HSC-Fräser mit gegenläufigen Spannuten

Durch den Wechsel der Spiralrichtung erzeugt der Fräser an der Oberseite einen Druck nach unten zur Mitte des Werkstücks und gleichzeitig an der Unterseite einen Gegendruck nach oben. In Verbindung mit den extrem scharfen Schneiden entsteht eine sehr saubere, gratfreie Oberfläche.

Butter-Fly Milling Cutters

The direction of the helix on this cutter changes. It generates downward pressure to the center of the workpiece and simultaneously generates upward counterpressure on the bottom side. In conjunction with the extremely sharp cutting edges, a very clean, burr-free surface can be obtained.

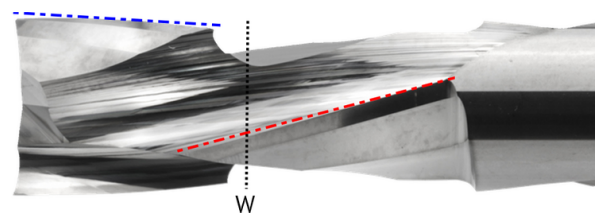

751 030

Hochleistungsfräser VHM Ungleiche Teilung Carbide High Performance End Mills Unequal Helix



- HPC-Schrupp- und Schlichtfräser
- Langspanende Werkstoffe
- 30° Spirale, ungleicher Stirnteilung
- Schutzfase an den Schneidecken
- Oberfläche poliert
- HPC roughing, finishing operations
- Long chipping materials, NF-metals
- 30° helix with unequal spacing
- Protective chamfer on cutting edges
- Polished finish

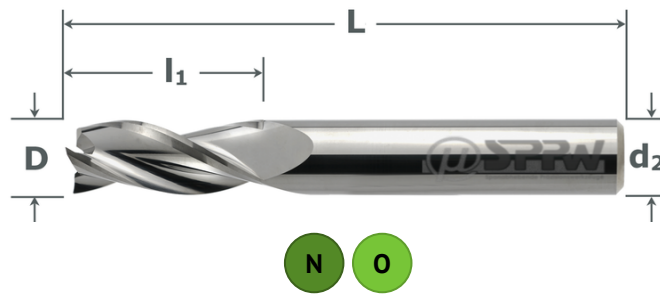

VHM	poliert
UT 30°	z:3
DIN 6535HA	

ØD h10	Ød2 h6	L	l1	z	Art. No.
3	6	57	10	3	7510300300
4	6	57	13	3	7510300400
5	6	57	15	3	7510300500
6	6	57	18	3	7510300600
7	8	63	20	3	7510300700
8	8	63	20	3	7510300800
9	10	72	22	3	7510300900

ØD h10	Ød2 h6	L	l1	z	Art. No.
10	10	72	25	3	7510301000
12	12	83	30	3	7510301200
14	14	83	30	3	7510301400
16	16	92	35	3	7510301600
18	18	92	35	3	7510301800
20	20	104	45	3	7510302000

751 010

HSC-Konturfräser VHM 3 Schneiden Geradegenutet Carbide HSC Contouring End Mills 3 Straight Flutes



- Leichtlegierungen, Kunststoffe
- Blech, Platten, dünnwandiges Material
- Gerade genutet mit Zentrumschnitt
- Keine Zugkräfte am Werkstück
- Mit 3 Schneiden, höhere Laufruhe
- Oberfläche poliert
- Light alloys, plastics, thin materials
- Straight flutes center cutting
- No drag or push on the workpiece
- With 3 flutes, smooth milling
- Polished finish

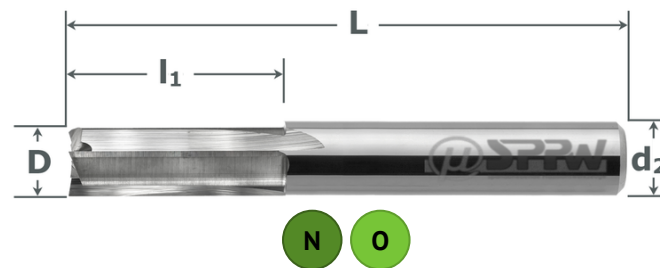

VHM	poliert
W 0°	z:3
DIN 6535HA	

ØD h10	Ød2 h6	L	l1	z	Art. No.
3	3	40	12	3	7510100300
4	4	40	14	3	7510100400
5	5	50	16	3	7510100500
6	6	50	18	3	7510100600
8	8	63	20	3	7510100800

ØD h10	Ød2 h6	L	l1	z	Art. No.
10	10	72	25	3	7510101000
12	12	83	30	3	7510101200
16	16	92	35	3	7510101600
20	20	104	45	3	7510102000

751 050**HSC-Schaftfräser VHM 3 Schneiden Linksdrall**
Carbide HSC End Mills 3 Flutes Left Hand Helix

- Leichtlegierungen und Kunststoffe
- Rechtsschneidend mit Linksspirale
- Spanauswurf nach unten
- Extrem scharfe Schneidkanten
- Oberfläche poliert
- Light alloys and plastics
- Left hand helix, right hand cutting
- Extremely sharp cutting edges
- Down-Cut, chip removal to bottom
- Polished finish

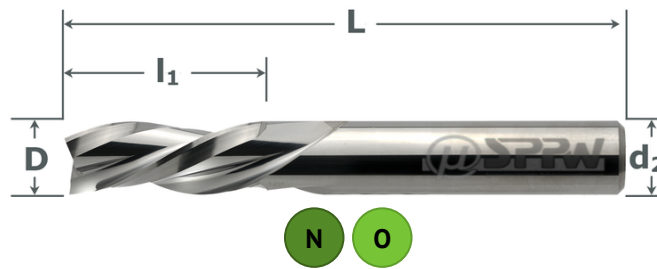

VHM	poliert
W 30°	z:3
DIN 6535HA	down cut

ØD h10	Ød2 h6	L	l1	z	Art. No.
3	3	40	12	3	7510500300
4	4	40	14	3	7510500400
5	5	50	16	3	7510500500
6	6	50	18	3	7510500600
8	8	63	20	3	7510500800

ØD h10	Ød2 h6	L	l1	z	Art. No.
10	10	72	25	3	7510501000
12	12	83	30	3	7510501200
16	16	92	35	3	7510501600
20	20	104	45	3	7510502000

751 031**HSC-Schaftfräser VHM Schaumstoff**
Carbide HSC End Mills Foams

- Schaumstoffe, besonders PE und PUR
- Rechtsschneidend mit Rechtsspirale
- Steile Spirale für gute Spanabfuhr
- Saubere Oberflächen bei Taschen
- Freistellung und Schutzfase
- Oberfläche poliert
- Foams, especially PE and PUR
- Right hand helix, right hand cutting
- Steep helix for good chip removal
- Smooth surfaces on slots, pockets
- Back clearance and protective chamfer
- Polished finish

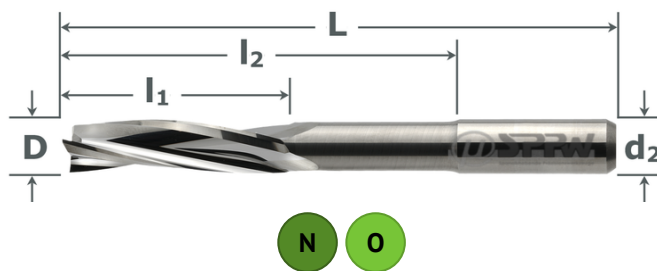

VHM	poliert
W 20°	z:3
DIN 6535HA	

ØD h10	Ød2 h6	L	l1	l2	z	Art. No.
3	3	75	20	40	3	7510310300
4	4	75	30	45	3	7510310401
5	5	75	25	45	3	7510310500
6	6	75	25	45	3	7510310601
6	6	100	40	70	3	7510310602
8	8	100	40	70	3	7510310801

ØD h10	Ød2 h6	L	l1	l2	z	Art. No.
8	8	150	40	115	3	7510310803
10	10	100	40	70	3	7510311001
10	10	120	50	85	3	7510311002
10	10	150	50	115	3	7510311003
12	12	125	50	85	3	7510311201
12	12	150	50	115	3	7510311202

— INFO —**Polierte Spannut**

Rapid-Line HSC-Fräser haben einen deutlich verbesserten Spanabfluss. Es treten geringere Bearbeitungstemperaturen auf, Überhitzung und Aufschweißungen werden vermieden. Rapid-Line Fräser haben eine deutlich längere Lebensdauer und es können zudem bessere Oberflächen erzielt werden.

Polished Flutes

Rapid-Line HSC cutters have significantly improved chip flow. Lower machining temperatures occur, overheating and welding are avoided. Rapid-Line milling cutters have a significantly longer tool life. Better surfaces can be achieved.

751 034

Planfräser mit HM-Kopf 3 Schneiden Carbide Surface Milling Cutter 3 Flutes



- Planfräsen größerer Oberflächen
- Langspanende Werkstoffe, NE-Metalle
- 30° Spirale mit Eckenradius 0,5 mm
- Stahlschaft mit gelötetem HM-Kopf
- Surface milling of larger areas
- Long chipping materials, NF-metals
- 30° helix with corner radius 0,5 mm
- Steel shank with brazed carbide head

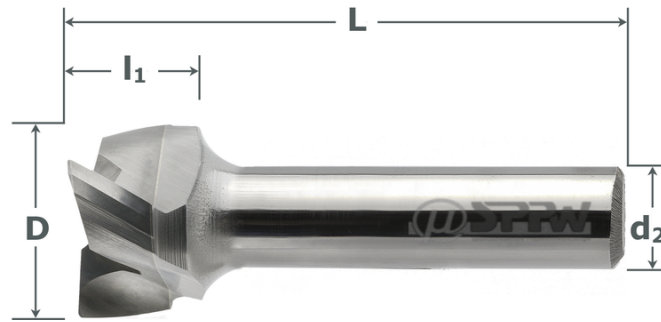

VHM	poliert
W 30°	z:3
DIN 6535HA	



ØD h10	Ød2 h8	L	l1	z	Art. No.
10	6	50	8	3	7510341000
12	6	50	8	3	7510341200
14	10	50	8	3	7510341400
16	10	50	8	3	7510341600

ØD h10	Ød2 h8	L	l1	z	Art. No.
18	10	50	8	3	7510341800
20	10	50	8	3	7510342000
30	12	50	8	3	7510343000

751 035

HSC-Radiusfräser VHM 3 Schneiden Carbide HSC Radius End Mills 3 Flutes



- HSC-Schrupp-/Schlichtfräser
- Langspanende Werkstoffe
- 30° Spirale, ungleiche Stirnteilung
- Oberfläche poliert
- Lieferzeit 5 - 8 Arbeitstage
- HSC roughing, finishing operations
- Long chipping materials, NF-metals
- 30° helix with unequal spacing
- Polished finish
- Delivery time 5 - 8 working days

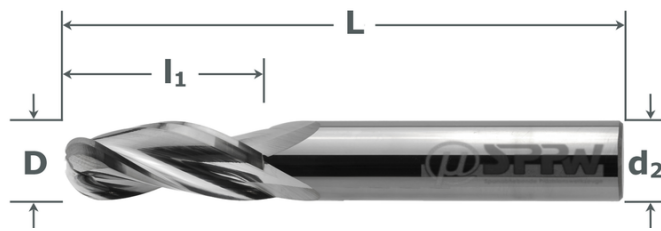

VHM	poliert
W 30°	z:3
DIN 6535HA	Radius



ØD h10	Ød2 h6	L	l1	z	Art. No.
3	6	57	10	3	7510350300
4	6	57	13	3	7510350400
5	6	57	15	3	7510350500
6	6	57	18	3	7510350600
7	8	63	20	3	7510350700
8	8	63	20	3	7510350800
9	10	72	22	3	7510350900

ØD h10	Ød2 h6	L	l1	z	Art. No.
10	10	72	25	3	7510351000
12	12	83	30	3	7510351200
14	14	83	30	3	7510351400
16	16	92	35	3	7510351600
18	18	92	35	3	7510351800
20	20	104	45	3	7510352000

751 190

HSC-Schaftfräser VHM für Fasergewebe 2 Schneiden Carbide Cross Cut HSC Router End Mills Aramid 2 Flutes



- Fasergewebewerkstoffe (Aramid)
- Gegenläufige Verzahnung
- Rechtsschneidend, Rechts-/Linksspirale
- Extrem scharfe Schneidkanten
- Keine Delamination bei Textilien
- Oberfläche poliert

- Woven fiber materials (Aramids)
- Up- and down-cut, right hand cutting
- Extremely sharp cutting edges
- No delamination in textile structure
- Polished finish

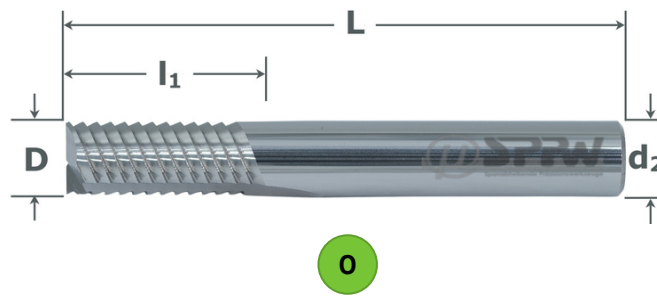

VHM	poliert
AFRP 0°	z:2 1+1
DIN 6535HA	

ØD h10	Ød2 h6	L	l1	Art. No.	ØD h10	Ød2 h6	L	l1	Art. No.
5	5	50	15	7511900500	8	8	63	18	7511900800
5	5	75	20	7511900500L	8	8	80	30	7511900800L
6	6	57	18	7511900600	10	10	72	20	7511901000
6	6	75	25	7511900600L	10	10	80	35	7511901000L

751 194

HSC-Schaftfräser VHM für Fasergewebe 4 Schneiden Carbide Cross Cut HSC Router End Mills Aramid 4 Flutes



- Fasergewebewerkstoffe (Aramid)
- Gegenläufige Verzahnung
- Rechtsschneidend, Rechts-/Linksspirale
- Extrem scharfe Schneidkanten
- Keine Delamination bei Textilien
- Oberfläche poliert

- Woven fiber materials (Aramids)
- Up- and down-cut, right hand cutting
- Extremely sharp cutting edges
- No delamination in textile structure
- Polished finish

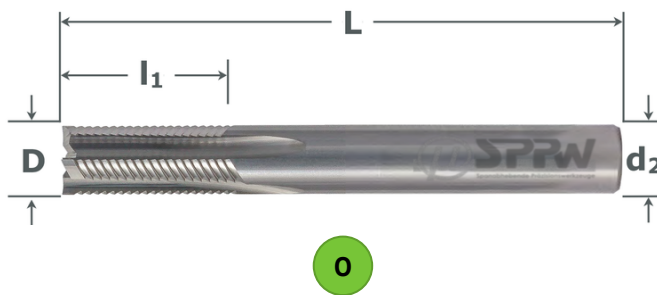

VHM	poliert
AFRP 0°	z:4 2+2
DIN 6535HA	

ØD h10	Ød2 h6	L	l1	z	Art. No.	ØD h10	Ød2 h6	L	l1	z	Art. No.
6	6	60	20	4	7511940600	10	10	72	32	4	7511941000
6	6	75	35	4	7511940601	10	10	100	50	4	7511941001
8	8	75	32	4	7511940800	12	12	83	32	4	7511941200
8	8	100	40	4	7511940801	12	12	120	55	4	7511941201

— INFO —



Gegenläufige Schneiden

Die gegenläufige Anordnung der Schneiden – up-cut und down-cut – erzeugt bei der Bearbeitung während einer Umdrehung Schnittkräfte in gegenüberliegende Richtungen. Die Schnittkräfte neutralisieren sich wechselseitig und schaffen so ein kräfteneutrales Werkzeug.

Opposed Cutting Edges

The opposed cutting edge alignment - up-cut and down-cut - generates cutting forces in opposite directions while machining. The cutting forces are neutralized, thus creating a force-neutral tool.

751 902**CNC Faskant-Umfangsfräser VHM 90°
Carbide V-Groove Milling Cutters 90°**

- V-Nutfräsen und Umfangsfräsen
- Aluminium-Verbundplatten
- Mit Kunststoffkern
- Einsatz auf CNC-Maschinen
- Oberfläche blank
- V-slotting and circumference milling
- Aluminum-composite-sheets
- With plastic core
- Version for CNC applications
- Bright finish

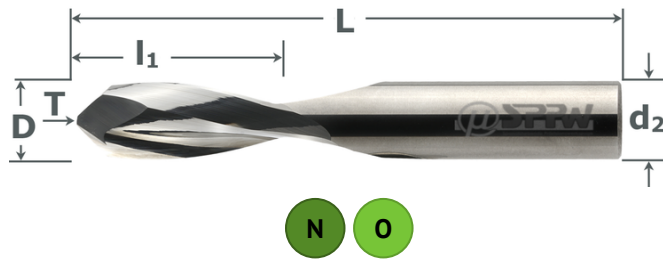

VHM	poliert
W 20°	90°
z:2	DIN 6535HA

ØD	Ød2	L	l1	z	T	Art. No.	ØD	Ød2	L	l1	z	T	Art. No.
4	4	50	10	2	0,4	7519020400	8	8	58	20	2	0,8	7519020800
6	6	54	16	2	0,6	7519020600	10	10	66	24	2	1	7519021000

751 900**Faskantfräser VHM 90° oder 135°
Carbide Creasing Cutters 90° or 135°**

- V-Nutfräsen zum späteren Kanten
- Aluminium-Verbundplatten
- Mit Kunststoffkern
- Kantwinkel 90° und 135°
- Oberfläche blank
- V-slotting for following folding
- Aluminum-plastic-sheets
- With plastic core
- Folding angles 90° and 135°
- Bright finish

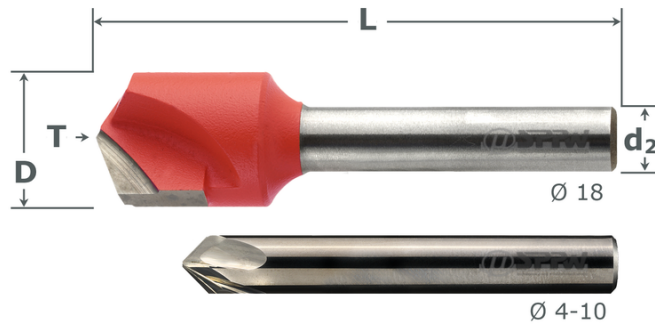

VHM	poliert
W 0°	90°
z: 2-4	DIN 6535HA

ØD	Ød2	L	a	z	T	Art. No.	ØD	Ød2	L	a	z	T	Art. No.
4	4	50	90°	2	0,4	7519000400	10	10	66	90°	4	1	7519001000
6	6	54	90°	2	0,6	7519000600	18	8	59	135°	2	2	7519001820
8	8	58	90°	4	0,8	7519000800	18	8	59	90°	2	3	7519001830

INFO**Aluminium-Verbundplatten**

Zuerst wird eine V-förmige Falz in die innenliegende Seite der Verbundplatte gefräst. Dabei sollte eine dünne Schicht des Kernmaterials stehen bleiben, um die Deckplatten zu schützen. Die verbleibende Deckplatte kann jetzt in die gewünschte Form gekantet werden. Das Kanten kann per Hand erfolgen. Es entsteht eine saubere Biegekante.

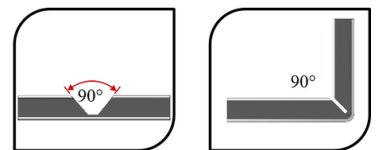
**ACM - Aluminum Composite Materials**

A V-shaped groove is milled into the opposite side of the ACM. A small layer of the plastic filling should remain to protect the cover sheet. The remaining outer cover sheet can now be bent to get the desired form. Folding can be done manually and will result in a clean folding line.

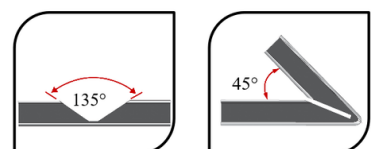

751 077

HSC-Schaftfräser VHM Waben-Verbundwerkstoffe
Carbide HSC End Mills Honeycomb



- Waben-Verbundwerkstoffe
- Extra Verzahnung, ziehender Schnitt
- Gute Oberfläche für die Weiterarbeit
- Extrem scharfe Schneidkanten
- Multiflute-Stirnverzahnung
- Ab Ø 14 mit HSS-Schaft

- Honeycomb materials
- Special flute geometry, dragging cut
- Good surfaces for further processing
- Extremely sharp cutting edges
- Multiflute point, straight shank
- From Ø 14 with HSS shank

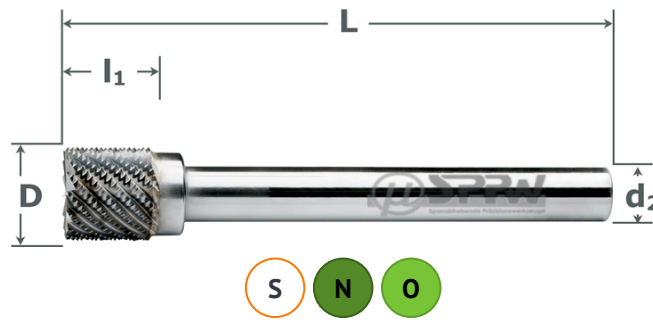

VHM	poliert
W 50°	z: multi
DIN 6535HA	Honey Comb

ØD h10	Ød2 h6	L	l1	Art. No.	ØD h10	Ød2 h6	L	l1	Art. No.
6	6	50	16	7510770600	16	12	100	17	7510771600
8	8	63	19	7510770800	20	12	100	17	7510772000
10	10	72	22	7510771000	24	12	100	10	7510772400
12	12	83	26	7510771200	24	12	100	17	7510772401
14	12	100	17	7510771400	44*	12	100	17	7510774400

751 078

Modulare Systemfräser VHM Honeycomb mit Schneidmesser
Modular Milling Cutters for Honeycomb with Circular Cutter



- Modularer Systemfräser
- Satz: Schaft, Fräser und Schneidmesser
- Verschiedene Konfigurationen
- Speziell für Waben-Verbundwerkstoffe
- Extrem scharfe Schneidkanten

- Modular milling system as set
- Set: arbor, hogger and blade
- Different configurations
- Honeycomb materials
- Good surfaces for further processing
- Extremely sharp cutting edges

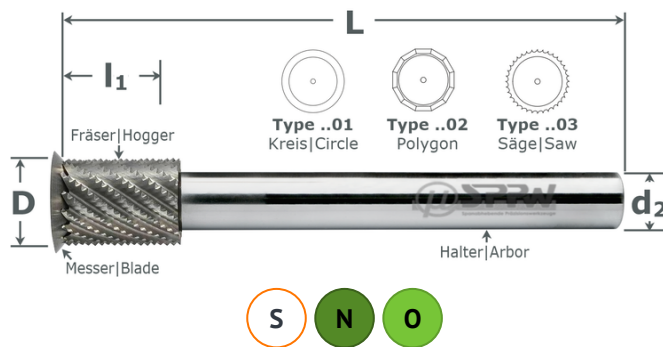

VHM	poliert
Set modulR	z: multi
DIN 6535HA	Honey Comb

ØD e9	Ød2 h6	L	l1	DE	EN	Art. No.
12	12	83	26	Kreis	Circle	7510781201
12	12	83	26	Polygon	Polygon	7510781202
12	12	83	26	Säge	Saw	7510781203
20	12	100	20	Kreis	Circle	7510782001
20	12	100	20	Polygon	Polygon	7510782002
20	12	100	20	Säge	Saw	7510782003
24	12	100	17	Kreis	Circle	7510782401
24	12	100	17	Polygon	Polygon	7510782402
24	12	100	17	Säge	Saw	7510782403
44	12	100	17	Kreis	Circle	7510784401
44	12	100	17	Polygon	Polygon	7510784402
44	12	100	17	Säge	Saw	7510784403

751 079**Modulare Systemfräser VHM Honeycomb - Einzelteile**
Modular Milling Cutters for Honeycomb - Spare Parts

- Modularer Systemfräser 751078
- Einzelne Bestandteile
- Kreismesser, Fräser und Halter
- Befestigung mittels Schraube M4
- Extrem scharfe Schneidkanten
- Modular milling system 751078
- Spare and extra parts
- Arbor, hogger and blade
- Assembly with screw M4
- Extremely sharp cutting edges

Teile
partsHoney
Comb**751078 Einzelteile | spare parts**

Größe size	Teil part	ØDxH	L	Art. No.
12	Fräskopf	12x26		7510781226
12	Halter	12x23	80	7510781278
12	Kreis	13x3-90°		7510781301
12	Polygon	13x3-90°		7510781302
12	Säge	13x3-90°		7510781303
20	Fräskopf	20x20		7510782020
20	Halter	12x17	97	7510782089
20	Kreis	21x3-120°		7510782101
20	Polygon	21x3-120°		7510782102
20	Säge	21x3-120°		7510782103
24	Fräskopf	24x17		7510782417
24+44	Halter	12x14	97	7510782444
24	Kreis	25x3-120°		7510782501
24	Polygon	25x3-120°		7510782502
24	Säge	25x3-120°		7510782503
44	Fräskopf	44x17		7510784417
44	Kreis	47x3-120°		7510784701
44	Polygon	47x3-120°		7510784702
44	Säge	47x3-120°		7510784703

- INFO



791 060

HSC-Kompressionsfräser VHM+Diamant
Carbide HSC Up and Down Cutter+Diamond



- Faserkunststoffe
- Gegenläufige Nuten mit Spanbrecher
- Spiralwechsel, Schnittkräfte mittig
- Simultan ziehend, schiebend
- Oberfläche Diamant beschichtet
- Fiber reinforced plastics
- Opposed helix with chip breaker
- Helix changes direction, right to left
- Simultaneous up down cut
- With diamond coating

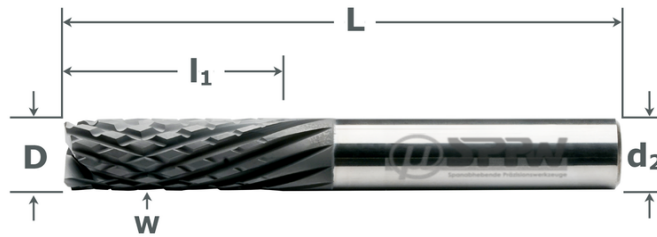

VHM	DIA Plus
W +20 -20	Multi
DIN 6535HA	GFK CFK

ØD h10	Ød2 h6	L	l1	Wechsel	Art. No.	ØD h10	Ød2 h6	L	l1	Wechsel	Art. No.
6	6	57	13	4	7910600604	10	10	72	22	7	7910601007
6	6	57	13	6,5	7910600606	10	10	72	22	11	7910601011
6	6	60	22	11	7910600611	10	10	78	35	17,5	7910601017
8	8	63	19	6	7910600806	12	12	83	26	8	7910601208
8	8	63	19	9,5	7910600809	12	12	83	25	13	7910601213
8	8	78	32	16	7910600816	12	12	83	40	20	7910601220

791 067

HSC-Schaftfräser VHM Diamant.Plus - CFK Geradegenutet
Carbide HSC End Mills+Diamond.Plus - CFRP



- Carbonfaser-Verbundwerkstoffe
- Optimierte Geometrie, Spanbrecher
- Fortlaufender Schnitt
- Gerade Nuten, keine Zugkräfte
- Oberfläche Diamant Aero
- Carbon fiber reinforced material
- Optimized geometry, chip breakers
- Continued cut, good chip removal
- Straight flutes, no drag
- Diamond Aero coating

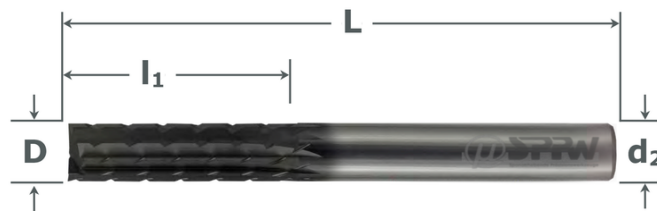

VHM	DIA Aero
WX 0°	Multi
DIN 6535HA	CFK carbone

ØD e9	Ød2 h6	L	l2	Art. No.	ØD e9	Ød2 h6	L	l2	Art. No.
4	6	80	16	7910670400	10	10	100	32	7910671000
6	6	80	20	7910670600	10	10	120	50	7910671001
6	6	100	35	7910670601	12	12	100	32	7910671200
8	8	100	32	7910670800	12	12	150	60	7910671201
8	8	120	40	7910670801					

791 069

HSC-Schaftfräser VHM+Diamant.Plus - CFK Down-Cut
Carbide HSC End Mills+Diamond.Plus - CFRP Down-Cut



- Carbonfaser-Verbundwerkstoffe
- optimierte Geometrie mit Spanbrecher
- Schiebender Schnitt - Down-Cut
- Oberfläche Diamant Aero
- Carbon fiber reinforced material
- Optimized Geometry with chip breaker
- Down-cut, chip removal to bottom
- Diamond Aero coating

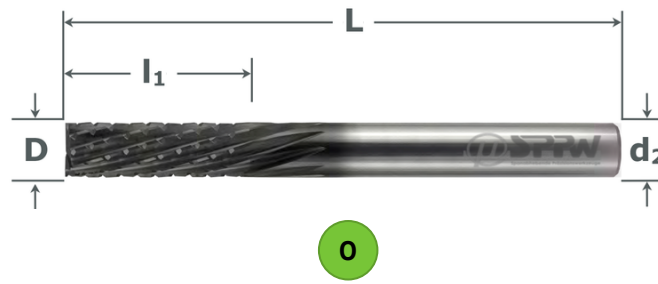

VHM	DIA Aero
WX -30°	Multi
DIN 6535HA	CFK carbone

ØD e9	Ød2 h6	L	l2	Art. No.	ØD e9	Ød2 h6	L	l2	Art. No.
4	6	80	16	7910690400	10	10	100	32	7910691000
6	6	80	20	7910690600	10	10	120	50	7910691001
6	6	100	35	7910690601	12	12	100	32	7910691200
8	8	100	32	7910690800	12	12	150	60	7910691201
8	8	120	40	7910690801					

791 065

HSC-Kopierfräser VHM Diamant.Plus - CFK
Carbide HSC End Copyind Mills+Diamond.Plus -CFRP



- Carbonfaser-Verbundwerkstoffe
- Vollradius zum Kopierfräsen
- Optimierte Geometrie, Spanbrecher
- Fortlaufender Schnitt
- Oberfläche Diamant Aero
- Carbon fiber reinforced material
- With radius for copying operations
- Optimized Geometry, chip breakers
- Continued cut, good chip removal
- With DiamondAero coating

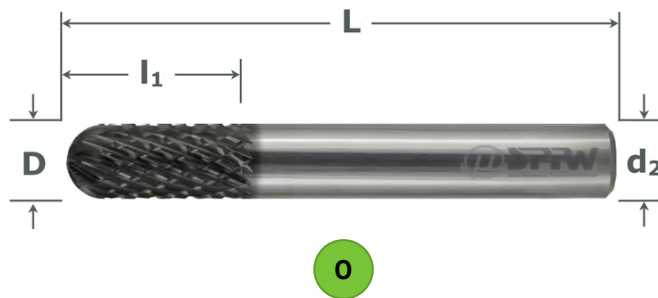

VHM	DIA Aero
WX 30°	DIN 6535HA
CFK carbone	

ØD -0,02	Ød2 h6	L	l1	Art. No.	ØD -0,02	Ød2 h6	L	l1	Art. No.
4	4	60	19	7910650400	10	10	72	37	7910651000
6	6	60	23	7910650600	12	12	83	38	7910651200
8	8	75	36	7910650800					

— INFO —



Dia.Aero Diamantbeschichtung

Entwickelt, um höchste Oberflächenqualität bei der Zerspaltung von CFK zu erreichen. Optimale Schichthaftung und einzigartigen Schichtglätte garantieren hohe Produktivität. Trotz einer Schichtdicke von bis zu 14 µm verändert sich die Mikrogeometrie des Fräasers nicht.

Dia.Aero Diamond Coating

Developed to provide the highest surface quality when machining CFRP. Optimal layer adhesion and unique layer smoothness guarantee high productivity. Despite a coating thickness of up to 14 µm the micro-geometry of the cutter does not change.



- Faserkunststoffe
- Gegenläufige Nuten mit Spanbrechern
- Spiralwechsel, Schnittkräfte mittig
- Simultan ziehend, schiebend
- Oberfläche Dia.HC beschichtet
- Fiber reinforced plastics
- Opposed helix with chip breaker
- Helix changes direction, right to left
- Dragging and compacting cut
- With Dia.HC coating

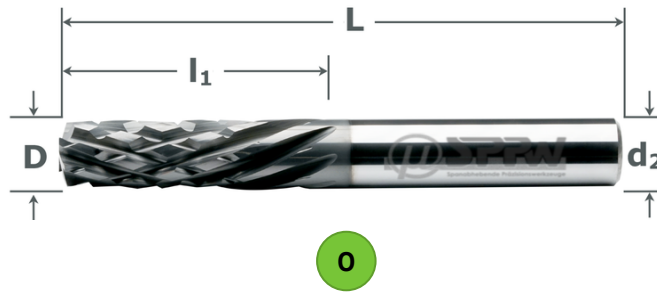

VHM	Dia HC
W +20 -20	Multi
DIN 6535HA	GFK CFK

ØD h10	Ød2 h6	L	l1	Wechsel	Art. No.
6	6	57	13	4	7510600604HC
6	6	57	13	6,5	7510600606HC
6	6	60	22	11	7510600611HC
8	8	63	19	6	7510600806HC
8	8	63	19	9,5	7510600809HC
8	8	78	32	16	7510600816HC

ØD h10	Ød2 h6	L	l1	Wechsel	Art. No.
10	10	72	22	7	7510601007HC
10	10	72	22	11	7510601011HC
10	10	78	35	17,5	7510601017HC
12	12	83	25	8	7510601208HC
12	12	83	26	13	7510601213HC
12	12	83	40	20	7510601220HC

— INFO —

Kompressionsfräsen

Der Kompressionsfräser löst typische Probleme, die bei der Bearbeitung von Faserkunststoffen auftreten:

- Delamination
- Oberflächengüte an den Schnittkanten
- Abtransport der Späne

Durch den Wechsel der Spiralrichtung erzeugt das Werkzeug an der Oberseite einen Druck nach unten zur Mitte des Werkstücks und gleichzeitig an der Unterseite einen Gegendruck nach oben zur Mitte des Werkstücks. Durch die Spanbrecher werden die Späne sauber gebrochen und schnell aus dem Prozess abgeführt, so dass sie nicht anhaften können.

Up and Down Compression Cutters

This milling cutter solves several of the problems that occur, when machining fibre reinforced plastics:

- Delamination
- Surface quality
- Chip control

The tool helix changes direction creating pressure from the top to the center and at the same time from the bottom to the center of the work piece, thus concentrating the axial effects in the middle of the workpiece. The chip breakers facilitate chip transport and remove chips rapidly from the cutting process.

Funktionsprinzip
working principle

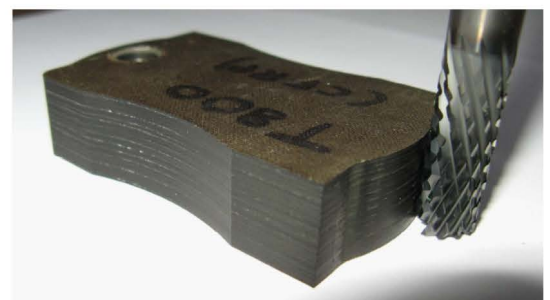
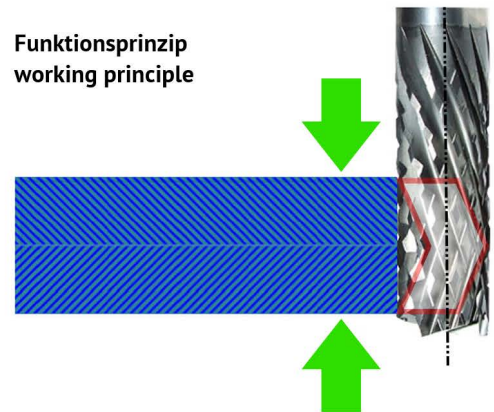

751 065

HSC-Schaftfräser VHM GFK / CFK 5 Schneiden Carbide HSC End Mills GFRP / CFRP 5 Flutes



- Faser-Verbundwerkstoffe
- Große Spannuten, gute Spanabfuhr
- Synchrone Spanbrecher
- Fortlaufender Schnitt
- Gerade Nuten, keine Zugkräfte
- Oberfläche poliert
- Fiber reinforced compound materials
- Big flutes, synchronized chip breakers
- Continued cut and good chip removal
- Straight flutes, no drag
- Polished finish

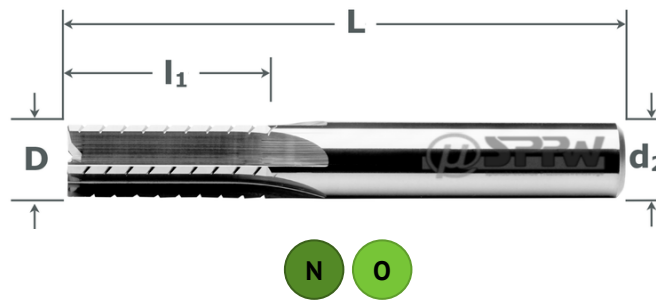

VHM	poliert
W 0°	z:5
DIN 6535HA	GFK CFK

ØD h10	Ød2 h6	L	l1	z	Art. No.	ØD h10	Ød2 h6	L	l1	z	Art. No.
2	6	57	7	5	7510650206	6	6	57	18	5	7510650600
3	6	57	12	5	7510650306	8	8	63	20	5	7510650800
4	6	57	14	5	7510650406	10	10	72	25	5	7510651000
5	6	57	16	5	7510650506	12	12	83	30	5	7510651200

751 065 HC

HSC-Schaftfräser VHM+Dia.HC GFK / CFK 5 Schneiden Carbide HSC End Mills+Dia.HC GFRP / CFRP 5 Flutes



- Faser-Verbundwerkstoffe
- Große Spannuten, gute Spanabfuhr
- Synchrone Spanbrecher
- Fortlaufender Schnitt
- Gerade Nuten, keine Zugkräfte
- Oberfläche Dia.HC beschichtet
- Fiber reinforced compound material
- Big flute, synchronized chip breakers
- Continued cut, good chip removal
- Straight flutes, no drag
- With Dia.HC coating

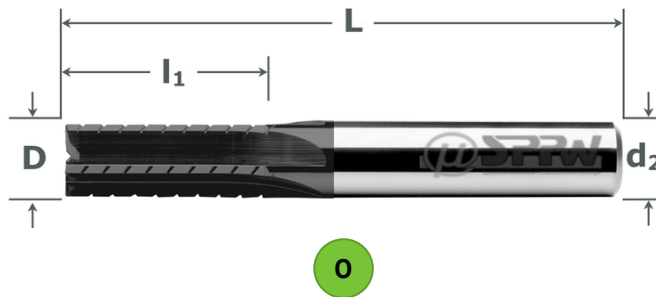

VHM	Dia HC
W 0°	z:5
DIN 6535HA	GFK CFK

ØD h10	Ød2 h6	L	l1	z	Art. No.	ØD h10	Ød2 h6	L	l1	z	Art. No.
2	6	57	7	5	7510650206HC	6	6	57	18	5	7510650600HC
3	6	57	12	5	7510650306HC	8	8	63	20	5	7510650800HC
4	6	57	14	5	7510650406HC	10	10	72	25	5	7510651000HC
5	6	57	16	5	7510650506HC	12	12	83	30	5	7510651200HC

751 066

HSC-Schaftfräser VHM GFK / CFK 6 Schneiden Carbide HSC End Mills GFRP / CFRP 6 Flutes



- Faser-Verbundwerkstoffe
- Große Spannuten, gute Spanabfuhr
- Synchrone Spanbrecher
- Fortlaufender Schnitt
- Oberfläche poliert
- Fiber reinforced compound materials
- Big flutes, easy chip removal
- Synchronized chip breakers
- Continued cut, good chip removal
- Polished finish

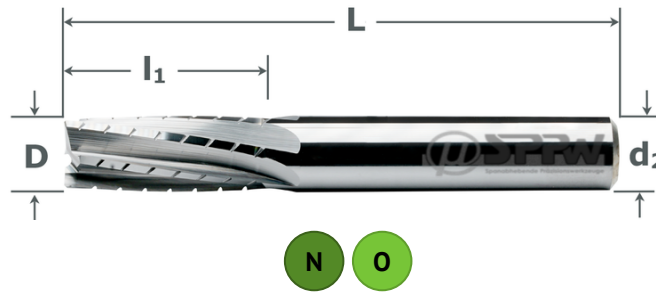

VHM	poliert
W 10°	z:6
DIN 6535HA	GFK CFK

ØD h10	Ød2 h6	L	l1	z	Art. No.	ØD h10	Ød2 h6	L	l1	z	Art. No.
2	6	57	7	6	7510660206	6	6	75	35	6	7510660601
3	6	57	12	6	7510660306	8	8	63	20	6	7510660800
4	6	57	20	6	7510660406	8	8	100	40	6	7510660801
5	6	57	16	6	7510660506	10	10	72	25	6	7510661000
6	6	57	18	6	7510660600	12	12	83	30	6	7510661200

751 066 HC

HSC-Schaftfräser VHM+Dia.HC GFK / CFK 6 Schneiden Carbide HSC End Mills+Dia.HC GFRP / CFRP 6 Flutes



- Faser-Verbundwerkstoffe
- Große Spannuten, gute Spanabfuhr
- Synchrone Spanbrecher
- Fortlaufender Schnitt
- Gerade Nuten, keine Zugkräfte
- Oberfläche Dia.HC beschichtet
- Fiber reinforced compound materials
- Big flutes, easy chip removal
- Synchronized chip breakers
- Continued cut, good chip removal
- With Dia.HC coating

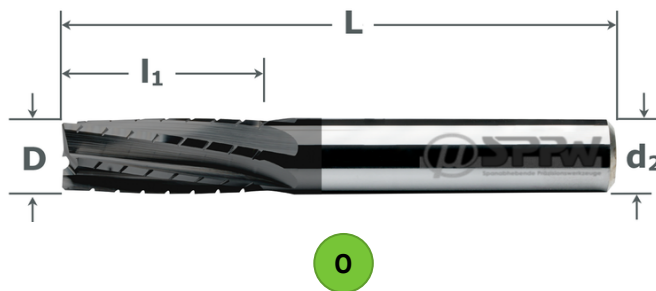

VHM	Dia HC
W 10°	z:6
DIN 6535HA	GFK CFK

ØD h10	Ød2 h6	L	l1	z	Art. No.	ØD h10	Ød2 h6	L	l1	z	Art. No.
2	6	57	7	6	7510660206HC	6	6	75	35	6	7510660601HC
3	6	57	12	6	7510660306HC	8	8	63	20	6	7510660800HC
4	6	57	20	6	7510660406HC	8	8	100	40	6	7510660801HC
5	6	57	16	6	7510660506HC	10	10	72	25	6	7510661000HC
6	6	57	18	6	7510660600HC	12	12	83	30	6	7510661200HC

— INFO —



Synchrone Spanbrecher

Durch eine Reihe synchronisierter Spanbrecher, wird das Material kontinuierlich geschnitten, gleichzeitig die Fasern gebrochen und abtransportiert. Durch die hohe Anzahl an Schneiden wird eine deutlich bessere Schnittleistung und somit ein größeres Spanvolumen erreicht.

Synchronized Chip Breakers

A sequence of synchronized chipbreakers continuously cuts the material and simultaneously breaks and transports the fibers away. Due to the high number of cutting edges, a significantly better cutting performance and thus a larger chip volume is achieved.

751 080 HC

HSC-Nutfräser VHM+Dia.HC - Nutfräserspitze Carbide HSC End Mills+Dia.HC - Slot Drill Point



- FVK mit hohem Faseranteil
- Pyramidenverzahnung
- Ziehender Schnitt
- Nutfräser: Bohren, Nuten, Besäumen
- Extrem scharfe Schneidkanten
- Oberfläche Dia.HC beschichtet
- FRP with high fiber content
- Pyramid cross cut profile, up cut
- Slot drill drilling, slotting, trimming
- Extremely sharp cutting edges
- With Dia.HC coating

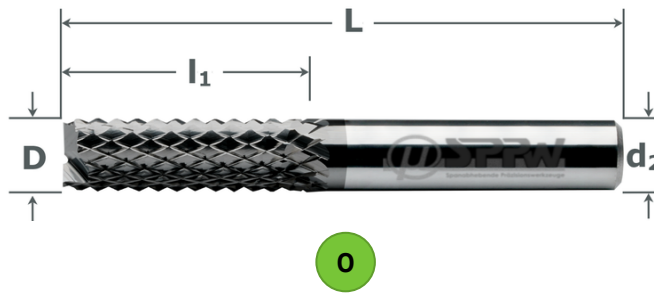

VHM	Dia HC
WX 30°	Multi
DIN 6535HA	GFK CFK

751080-F - fein | fine profile

ØD h10	Ød2 h6	L	l1	Art. No.
2	2	40	7	751080020FHC
2	6	50	7	751080026FHC
3	3	40	10	751080030FHC
3	6	50	12	751080036FHC
4	4	40	15	751080040FHC
4	6	50	20	751080046FHC

ØD h10	Ød2 h6	L	l1	Art. No.
5	5	50	16	751080050FHC
5	6	75	25	751080056FHC
6	6	50	18	751080060FHC
6	6	75	35	751080066FHC
8	8	63	25	751080080FHC
8	8	100	40	751080081FHC

ØD h10	Ød2 h6	L	l1	Art. No.
10	10	72	30	751080100FHC
12	12	83	32	751080120FHC
14	14	83	32	751080140FHC
16	16	92	36	751080160FHC
18	18	92	40	751080180FHC
20	20	104	45	751080200FHC

751080-M - mittel | medium profile

ØD h10	Ød2 h6	L	l1	Art. No.
2	2	40	7	751080020MHC
2	6	50	7	751080026MHC
3	3	40	10	751080030MHC
3	6	50	12	751080036MHC
4	4	40	15	751080040MHC
4	6	50	20	751080046MHC

ØD h10	Ød2 h6	L	l1	Art. No.
5	5	50	16	751080050MHC
5	6	75	25	751080056MHC
6	6	50	18	751080060MHC
6	6	75	35	751080066MHC
8	8	63	25	751080080MHC
8	8	100	40	751080081MHC

ØD h10	Ød2 h6	L	l1	Art. No.
10	10	72	30	751080100MHC
12	12	83	32	751080120MHC
14	14	83	32	751080140MHC
16	16	92	36	751080160MHC
18	18	92	40	751080180MHC
20	20	104	45	751080200MHC

751080-G - grob | coarse profile

ØD h10	Ød2 h6	L	l1	Art. No.
2	2	40	7	751080020GHC
2	6	50	7	751080026GHC
3	3	40	10	751080030GHC
3	6	50	12	751080036GHC
4	4	40	15	751080040GHC
4	6	50	20	751080046GHC

ØD h10	Ød2 h6	L	l1	Art. No.
5	5	50	16	751080050GHC
5	6	75	25	751080056GHC
6	6	50	18	751080060GHC
6	6	75	35	751080066GHC
8	8	63	25	751080080GHC
8	8	100	40	751080081GHC

ØD h10	Ød2 h6	L	l1	Art. No.
10	10	72	30	751080100GHC
12	12	83	32	751080120GHC
14	14	83	32	751080140GHC
16	16	92	36	751080160GHC
18	18	92	40	751080180GHC
20	20	104	45	751080200GHC

751 080

HSC-Nutfräser VHM - Nutfräserspitze Carbide HSC End Mills - Slot Drill Point



- FVK mit hohem Faseranteil
- Pyramidenverzahnung
- Ziehender Schnitt
- Nutfräser: Bohren, Nuten, Besäumen
- Extrem scharfe Schneidkanten
- Oberfläche poliert
- FRP with high fiber content
- Pyramid cross cut profile, up cut
- Slot drill: drilling, slotting, trimming
- Extremely sharp cutting edges
- Polished finish

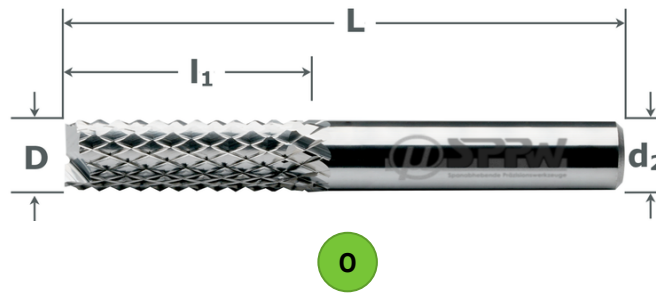

VHM	poliert
WX 30°	Multi
DIN 6535HA	GFK CFK

751080-F - fein | fine profile

ØD h10	Ød2 h6	L	l1	Art. No.
2	2	40	7	751080020F
2	6	50	7	751080026F
3	3	40	10	751080030F
3	6	50	12	751080036F
4	4	40	15	751080040F
4	6	50	20	751080046F

ØD h10	Ød2 h6	L	l1	Art. No.
5	5	50	16	751080050F
5	6	75	25	751080056F
6	6	50	18	751080060F
6	6	75	35	751080066F
8	8	63	25	751080080F
8	8	100	40	751080081F

ØD h10	Ød2 h6	L	l1	Art. No.
10	10	72	30	751080100F
12	12	83	32	751080120F
14	14	83	32	751080140F
16	16	92	36	751080160F
18	18	92	40	751080180F
20	20	104	45	751080200F

751080-M - mittel | medium profile

ØD h10	Ød2 h6	L	l1	Art. No.
2	2	40	7	751080020M
2	6	50	7	751080026M
3	3	40	10	751080030M
3	6	50	12	751080036M
4	4	40	15	751080040M
4	6	50	20	751080046M

ØD h10	Ød2 h6	L	l1	Art. No.
5	5	50	16	751080050M
5	6	75	25	751080056M
6	6	50	18	751080060M
6	6	75	35	751080066M
8	8	63	25	751080080M
8	8	100	40	751080081M

ØD h10	Ød2 h6	L	l1	Art. No.
10	10	72	30	751080100M
12	12	83	32	751080120M
14	14	83	32	751080140M
16	16	92	36	751080160M
18	18	92	40	751080180M
20	20	104	45	751080200M

751080-G - grob | coarse profile

ØD h10	Ød2 h6	L	l1	Art. No.
2	2	40	7	751080020G
2	6	50	7	751080026G
3	3	40	10	751080030G
3	6	50	12	751080036G
4	4	40	15	751080040G
4	6	50	20	751080046G

ØD h10	Ød2 h6	L	l1	Art. No.
5	5	50	16	751080050G
5	6	75	25	751080056G
6	6	50	18	751080060G
6	6	75	35	751080066G
8	8	63	25	751080080G
8	8	100	40	751080081G

ØD h10	Ød2 h6	L	l1	Art. No.
10	10	72	30	751080100G
12	12	83	32	751080120G
14	14	83	32	751080140G
16	16	92	36	751080160G
18	18	92	40	751080180G
20	20	104	45	751080200G

751 070 HC

HSC-Schaftfräser VHM+Dia.HC - Vielzahn-Stirnverzahnung Carbide HSC End Mills+Dia.HC - Multiflute Point



- FVK mit hohem Faseranteil
- Pyramidenverzahnung
- Ziehender Schnitt
- Vielzahn-Fräserstirn zum Stirnfräsen
- Extrem scharfe Schneidkanten
- Oberfläche Dia.HC beschichtet
- Fine: FRP with high fiber content
- Pyramid cross cut profile, up cut
- Multiflute point for front milling
- Extremely sharp cutting edges
- With Dia.HC coating

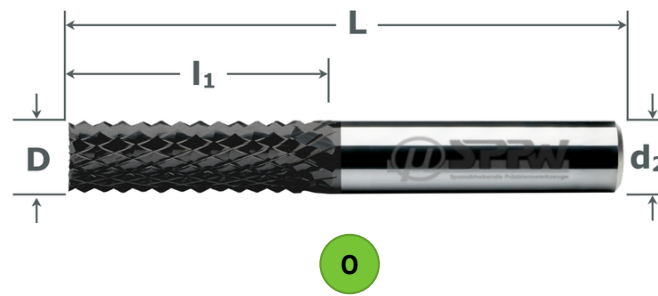

VHM	Dia HC
WX 30°	Multi
DIN 6535HA	GFK CFK

751070-F - fein | fine profile

ØD h10	Ød2 h6	L	l1	Art. No.
2	2	40	7	751070020FHC
2	6	50	7	751070026FHC
3	3	40	10	751070030FHC
3	6	50	12	751070036FHC
4	4	40	15	751070040FHC
4	6	50	20	751070046FHC

ØD h10	Ød2 h6	L	l1	Art. No.
5	5	50	16	751070050FHC
5	6	75	25	751070056FHC
6	6	50	18	751070060FHC
6	6	75	35	751070066FHC
8	8	63	25	751070080FHC
8	8	100	40	751070081FHC

ØD h10	Ød2 h6	L	l1	Art. No.
10	10	72	30	751070100FHC
12	12	83	32	751070120FHC
14	14	83	32	751070140FHC
16	16	92	36	751070160FHC
18	18	92	40	751070180FHC
20	20	104	45	751070200FHC

751070-M - mittel | medium profile

ØD h10	Ød2 h6	L	l1	Art. No.
2	2	40	7	751070020MHC
2	6	50	7	751070026MHC
3	3	40	10	751070030MHC
3	6	50	12	751070036MHC
4	4	40	15	751070040MHC
4	6	50	20	751070046MHC

ØD h10	Ød2 h6	L	l1	Art. No.
5	5	50	16	751070050MHC
5	6	75	25	751070056MHC
6	6	50	18	751070060MHC
6	6	75	35	751070066MHC
8	8	63	25	751070080MHC
8	8	100	40	751070081MHC

ØD h10	Ød2 h6	L	l1	Art. No.
10	10	72	30	751070100MHC
12	12	83	32	751070120MHC
14	14	83	32	751070140MHC
16	16	92	36	751070160MHC
18	18	92	40	751070180MHC
20	20	104	45	751070200MHC

751070-G - grob | coarse profile

ØD h10	Ød2 h6	L	l1	Art. No.
2	2	40	7	751070020GHC
2	6	50	7	751070026GHC
3	3	40	10	751070030GHC
3	6	50	12	751070036GHC
4	4	40	15	751070040GHC
4	6	50	20	751070046GHC

ØD h10	Ød2 h6	L	l1	Art. No.
5	5	50	16	751070050GHC
5	6	75	25	751070056GHC
6	6	50	18	751070060GHC
6	6	75	35	751070066GHC
8	8	63	25	751070080GHC
8	8	100	40	751070081GHC

ØD h10	Ød2 h6	L	l1	Art. No.
10	10	72	30	751070100GHC
12	12	83	32	751070120GHC
14	14	83	32	751070140GHC
16	16	92	36	751070160GHC
18	18	92	40	751070180GHC
20	20	104	45	751070200GHC

751 070**HSC-Schaftfräser VHM - Vielzahn-Stirnverzahnung
Carbide HSC End Mills - Multiflute Point**

- FVK mit hohem Faseranteil
 - Pyramidenverzahnung
 - Ziehender Schnitt
 - Nutfräser: Bohren, Nuten, Besäumen
 - Extrem scharfe Schneidkanten
 - Oberfläche poliert
-
- Fine: FRP with high fiber content
 - Pyramid cross cut profile, up cut
 - Multiflute point for front milling
 - Extremely sharp cutting edges
 - Polished finish

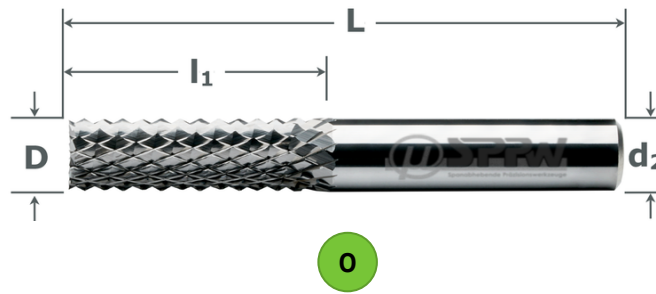

VHM	poliert
WX 30°	Multi
DIN 6535HA	GFK CFK

751070-F - fein | fine profile

ØD h10	Ød2 h6	L	l1	Art. No.
2	2	40	7	751070020F
2	6	50	7	751070026F
3	3	40	10	751070030F
3	6	50	12	751070036F
4	4	40	15	751070040F
4	6	50	20	751070046F

ØD h10	Ød2 h6	L	l1	Art. No.
5	5	50	16	751070050F
5	6	75	25	751070056F
6	6	50	18	751070060F
6	6	75	35	751070066F
8	8	63	25	751070080F
8	8	100	40	751070081F

ØD h10	Ød2 h6	L	l1	Art. No.
10	10	72	30	751070100F
12	12	83	32	751070120F
14	14	83	32	751070140F
16	16	92	36	751070160F
18	18	92	40	751070180F
20	20	104	45	751070200F

751070-M - mittel | medium profile

ØD h10	Ød2 h6	L	l1	Art. No.
2	2	40	7	751070020M
2	6	50	7	751070026M
3	3	40	10	751070030M
3	6	50	12	751070036M
4	4	40	15	751070040M
4	6	50	20	751070046M

ØD h10	Ød2 h6	L	l1	Art. No.
5	5	50	16	751070050M
5	6	75	25	751070056M
6	6	50	18	751070060M
6	6	75	35	751070066M
8	8	63	25	751070080M
8	8	100	40	751070081M

ØD h10	Ød2 h6	L	l1	Art. No.
10	10	72	30	751070100M
12	12	83	32	751070120M
14	14	83	32	751070140M
16	16	92	36	751070160M
18	18	92	40	751070180M
20	20	104	45	751070200M

751070-G - grob | coarse profile

ØD h10	Ød2 h6	L	l1	Art. No.
2	2	40	7	751070020G
2	6	50	7	751070026G
3	3	40	10	751070030G
3	6	50	12	751070036G
4	4	40	15	751070040G
4	6	50	20	751070046G

ØD h10	Ød2 h6	L	l1	Art. No.
5	5	50	16	751070050G
5	6	75	25	751070056G
6	6	50	18	751070060G
6	6	75	35	751070066G
8	8	63	25	751070080G
8	8	100	40	751070081G

ØD h10	Ød2 h6	L	l1	Art. No.
10	10	72	30	751070100G
12	12	83	32	751070120G
14	14	83	32	751070140G
16	16	92	36	751070160G
18	18	92	40	751070180G
20	20	104	45	751070200G

751 090 HC

HSC-Bohrfräser VHM+Dia.HC - Bohrerspitze Carbide HSC End Mills+Dia.HC - Drill Point



- FVK mit hohem Faseranteil
- Pyramidenverzahnung
- Ziehender Schnitt
- Bohrerspitze 135°: Bohren, Besäumen
- Extrem scharfe Schneidkanten
- Oberfläche Dia.HC beschichtet
- FRP with high fiber content
- Pyramid cross cut profile, up cut
- 135° drill point: drilling, trimming
- Extremely sharp cutting edges
- With Dia.HC coating

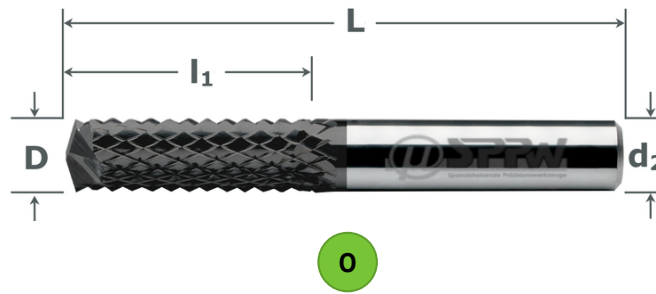

VHM	Dia HC
WX 30°	Multi
DIN 6535HA	GFK CFK

751090-F - fein | fine profile

ØD h10	Ød2 h6	L	l1	Art. No.
2	2	40	7	751090020FHC
2	6	50	7	751090026FHC
3	3	40	10	751090030FHC
3	6	50	12	751090036FHC
4	4	40	15	751090040FHC
4	6	50	20	751090046FHC

ØD h10	Ød2 h6	L	l1	Art. No.
5	5	50	16	751090050FHC
5	6	75	25	751090056FHC
6	6	50	18	751090060FHC
6	6	75	35	751090066FHC
8	8	63	25	751090080FHC
8	8	100	40	751090081FHC

ØD h10	Ød2 h6	L	l1	Art. No.
10	10	72	30	751090100FHC
12	12	83	32	751090120FHC
14	14	83	32	751090140FHC
16	16	92	36	751090160FHC
18	18	92	40	751090180FHC
20	20	104	45	751090200FHC

751090-M - mittel | medium profile

ØD h10	Ød2 h6	L	l1	Art. No.
2	2	40	7	751090020MHC
2	6	50	7	751090026MHC
3	3	40	10	751090030MHC
3	6	50	12	751090036MHC
4	4	40	15	751090040MHC
4	6	50	20	751090046MHC

ØD h10	Ød2 h6	L	l1	Art. No.
5	5	50	16	751090050MHC
5	6	75	25	751090056MHC
6	6	50	18	751090060MHC
6	6	75	35	751090066MHC
8	8	63	25	751090080MHC
8	8	100	40	751090081MHC

ØD h10	Ød2 h6	L	l1	Art. No.
10	10	72	30	751090100MHC
12	12	83	32	751090120MHC
14	14	83	32	751090140MHC
16	16	92	36	751090160MHC
18	18	92	40	751090180MHC
20	20	104	45	751090200MHC

751090-G - grob | coarse profile

ØD h10	Ød2 h6	L	l1	Art. No.
2	2	40	7	751090020GHC
2	6	50	7	751090026GHC
3	3	40	10	751090030GHC
3	6	50	12	751090036GHC
4	4	40	15	751090040GHC
4	6	50	20	751090046GHC

ØD h10	Ød2 h6	L	l1	Art. No.
5	5	50	16	751090050GHC
5	6	75	25	751090056GHC
6	6	50	18	751090060GHC
6	6	75	35	751090066GHC
8	8	63	25	751090080GHC
8	8	100	40	751090081GHC

ØD h10	Ød2 h6	L	l1	Art. No.
10	10	72	30	751090100GHC
12	12	83	32	751090120GHC
14	14	83	32	751090140GHC
16	16	92	36	751090160GHC
18	18	92	40	751090180GHC
20	20	104	45	751090200GHC

751 090**HSC-Bohrfräser VHM - Bohrerspitze**
Carbide HSC End Mills - Drill Point

- FVK mit hohem Faseranteil
- Pyramidenverzahnung
- Ziehender Schnitt
- Bohrerspitze 135°: Bohren, Besäumen
- Extrem scharfe Schneidkanten
- Oberfläche poliert
- Pyramid cross cut profile, up cut
- 135° drill point: drilling and trimming
- Extremely sharp cutting edges
- Fine: FRP with high fiber content
- Polished finish

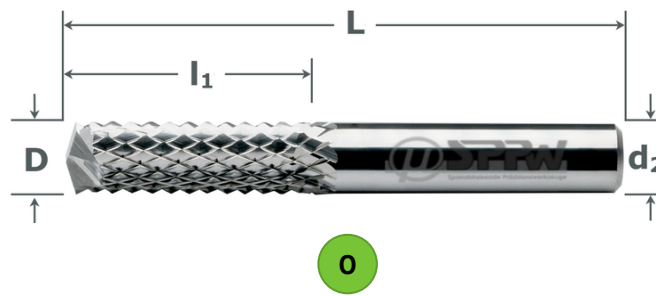

VHM	poliert
WX 30°	Multi
DIN 6535HA	GFK CFK

751090-F - fein | fine profile

ØD h10	Ød2 h6	L	l1	Art. No.
2	2	40	7	751090020F
2	6	50	7	751090026F
3	3	40	10	751090030F
3	6	50	12	751090036F
4	4	40	15	751090040F
4	6	50	20	751090046F

ØD h10	Ød2 h6	L	l1	Art. No.
5	5	50	16	751090050F
5	6	75	25	751090056F
6	6	50	18	751090060F
6	6	75	35	751090066F
8	8	63	25	751090080F
8	8	100	40	751090081F

ØD h10	Ød2 h6	L	l1	Art. No.
10	10	72	30	751090100F
12	12	83	32	751090120F
14	14	83	32	751090140F
16	16	92	36	751090160F
18	18	92	40	751090180F
20	20	104	45	751090200F

751090-M - mittel | medium profile

ØD h10	Ød2 h6	L	l1	Art. No.
2	2	40	7	751090020M
2	6	50	7	751090026M
3	3	40	10	751090030M
3	6	50	12	751090036M
4	4	40	15	751090040M
4	6	50	20	751090046M

ØD h10	Ød2 h6	L	l1	Art. No.
5	5	50	16	751090050M
5	6	75	25	751090056M
6	6	50	18	751090060M
6	6	75	35	751090066M
8	8	63	25	751090080M
8	8	100	40	751090081M

ØD h10	Ød2 h6	L	l1	Art. No.
10	10	72	30	751090100M
12	12	83	32	751090120M
14	14	83	32	751090140M
16	16	92	36	751090160M
18	18	92	40	751090180M
20	20	104	45	751090200M

751090-G - grob | coarse profile

ØD h10	Ød2 h6	L	l1	Art. No.
2	2	40	7	751090020G
2	6	50	7	751090026G
3	3	40	10	751090030G
3	6	50	12	751090036G
4	4	40	15	751090040G
4	6	50	20	751090046G

ØD h10	Ød2 h6	L	l1	Art. No.
5	5	50	16	751090050G
5	6	75	25	751090056G
6	6	50	18	751090060G
6	6	75	35	751090066G
8	8	63	25	751090080G
8	8	100	40	751090081G

ØD h10	Ød2 h6	L	l1	Art. No.
10	10	72	30	751090100G
12	12	83	32	751090120G
14	14	83	32	751090140G
16	16	92	36	751090160G
18	18	92	40	751090180G
20	20	104	45	751090200G

751 085 HC

HSC-Schaftfräser VHM+Dia.HC - Stirnradius Carbide HSC End Mills+Dia.HC - Stirnradius



- FVK mit hohem Faseranteil
- Pyramidenverzahnung
- Ziehender Schnitt
- Stirnradius für Kopierbearbeitung
- Extrem scharfe Schneidkanten
- Oberfläche Dia.HC beschichtet
- FRP with high fiber content
- Pyramid cross cut profile, up cut
- Radius for copying operations
- Extremely sharp cutting edges
- With Dia.HC coating

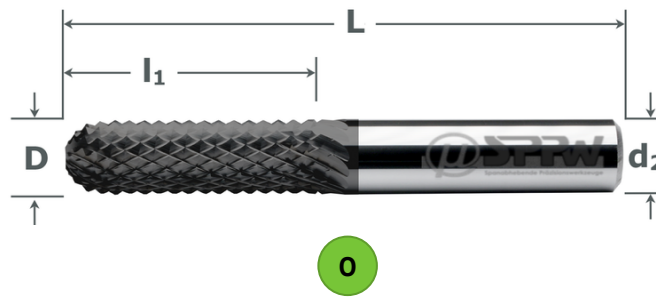

VHM	Dia HC
WX 30°	Multi
DIN 6535HA	GFK CFK

751085-F - fein | fine profile

ØD h10	Ød2 h6	L	l1	Art. No.	ØD h10	Ød2 h6	L	l1	Art. No.	ØD h10	Ød2 h6	L	l1	Art. No.
3	3	40	10	751085030FHC	5	6	75	25	751085056FHC	10	10	72	30	751085100FHC
3	6	50	12	751085036FHC	6	6	50	18	751085060FHC	12	12	83	32	751085120FHC
4	4	40	15	751085040FHC	6	6	75	35	751085066FHC	16	16	92	36	751085160FHC
4	6	50	20	751085046FHC	8	8	63	25	751085080FHC	20	20	104	45	751085200FHC
5	5	50	16	751085050FHC	8	8	100	40	751085081FHC					

751085-M - mittel | medium profile

ØD h10	Ød2 h6	L	l1	Art. No.	ØD h10	Ød2 h6	L	l1	Art. No.	ØD h10	Ød2 h6	L	l1	Art. No.
3	3	40	10	751085030MHC	5	6	75	25	751085056MHC	10	10	72	30	751085100MHC
3	6	50	12	751085036MHC	6	6	50	18	751085060MHC	12	12	83	32	751085120MHC
4	4	40	15	751085040MHC	6	6	75	35	751085066MHC	16	16	92	36	751085160MHC
4	6	50	20	751085046MHC	8	8	63	25	751085080MHC	20	20	104	45	751085200MHC
5	5	50	16	751085050MHC	8	8	100	40	751085081MHC					

— INFO



Beschichtung

Die Anforderungen unserer Kunden sind vielfältig. Je nach Bearbeitungsprozess bieten wir unterschiedliche Beschichtungen zur Optimierung der Bearbeitung. Ob eine extrem dünne Dia.HC-Schicht oder eine Multilagen-Diamantschicht, wir haben die richtige Beschichtung für Ihre Anwendung.

Coating

The requirements of our customers are diverse. Depending on the manufacturing task, we offer different coatings to optimize the machining process. Whether an extremely thin Dia.HC coating or a multilayer diamond coating, we have the right coating for your application.

751 085

HSC-Schaftfräser VHM - Stirnradius
Carbide HSC End Mills - Radius



- FVK mit hohem Faseranteil
- Pyramidenverzahnung
- Ziehender Schnitt
- Stirnradius für Kopierbearbeitung
- Extrem scharfe Schneidkanten
- Oberfläche poliert
- Fine: FRP with high fiber content
- Pyramid cross cut profile, up cut
- Radius for copying operations
- Extremely sharp cutting edges
- Polished finish

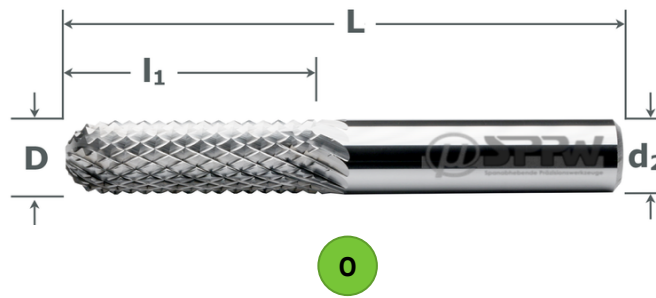

VHM	poliert
WX 30°	Multi
DIN 6535HA	GFK CFK

751085-F - fein | fine profile

ØD h10	Ød2 h6	L	l1	Art. No.	ØD h10	Ød2 h6	L	l1	Art. No.	ØD h10	Ød2 h6	L	l1	Art. No.
3	3	40	10	751085030F	5	6	75	25	751085056F	10	10	72	30	751085100F
3	6	50	12	751085036F	6	6	50	18	751085060F	12	12	83	32	751085120F
4	4	40	15	751085040F	6	6	75	35	751085066F	16	16	92	36	751085160F
4	6	50	20	751085046F	8	8	63	25	751085080F	20	20	104	45	751085200F
5	5	50	16	751085050F	8	8	100	40	751085081F	8	8	100	40	751085B082FHC-STKL

751085-M - mittel | medium profile

ØD h10	Ød2 h6	L	l1	Art. No.	ØD h10	Ød2 h6	L	l1	Art. No.	ØD h10	Ød2 h6	L	l1	Art. No.
3	3	40	10	751085030M	5	6	75	25	751085056M	10	10	72	30	751085100M
3	6	50	12	751085036M	6	6	50	18	751085060M	12	12	83	32	751085120M
4	4	40	15	751085040M	6	6	75	35	751085066M	16	16	92	36	751085160M
4	6	50	20	751085046M	8	8	63	25	751085080M	20	20	104	45	751085200M
5	5	50	16	751085050M	8	8	100	40	751085081M					

— INFO —



Fräser mit Pyramidenverzahnung zur Bearbeitung von Kompositen

Pyramidverzahnte Fräser werden in einem speziellen Schleifverfahren hergestellt. Es kombiniert zwei wichtige Eigenschaften: polierte Spannuten und scharfe Schneidkanten.

- Geringer Reibungskoeffiziente
- Hohe Schnitthaltigkeit
- Bessere Spanabfuhr
- Lange Werkzeuglebensdauer

End Mills with Pyramid Cross Cut Profile for Composite Materials

Pyramid cross cut end mills are produced with special grinding method. It combines two important elements: polished flutes and sharp cutting edges.

- Low friction coefficient
- High cutting accuracy
- Better chip evacuation
- Longer tool life

792 644

HSC-Torusfräser VHM+Diamant Lang + Überlang
Carbide Torical HSC End Mills+Diamond Long + Extra Long



- Grafit und Grünlinge
- Lange und überlange Ausführung
- Freistellung nach der Schneide
- Eckenradius für Kopierarbeiten
- Oberfläche Diamant beschichtet
- Graphite and greens
- Long and extra long series
- Back clearance after primary edge
- Corner radius for copying operations
- With diamond coating

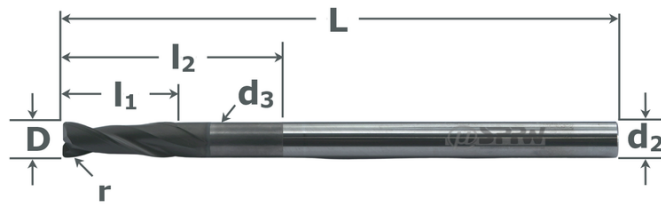

VHM	DIA Graph
z:2	DIN 6535HA
L lang	Grafit

ØD h10	Ød2 h6	L	l1	l2	z	r Radius	Ød3	Art. No.
2	3	50	6	12	2	0,5	1,9	7926440205
2	3	100	10	20	2	0,5	1,9	7926440210
3	3	60	8	16	2	0,5	2,9	7926440306
3	3	100	12	24	2	0,5	2,9	7926440310
4	4	60	10	20	2	0,5	3,8	7926440406
4	4	100	15	30	2	0,5	3,8	7926440410
5	5	60	12	24	2	0,5	4,8	7926440506
5	5	100	15	30	2	0,5	4,8	7926440510
6	6	75	20	40	2	0,5	5,8	7926440607
6	6	100	25	50	2	0,5	5,8	7926440610

ØD h10	Ød2 h6	L	l1	l2	z	r Radius	Ød3	Art. No.
6	6	150	30	60	2	0,5	5,8	7926440615
8	8	75	20	40	2	1	7,8	7926440807
8	8	100	25	50	2	1	7,8	7926440810
8	8	150	30	60	2	1	7,8	7926440815
10	10	100	25	50	2	1	9,8	7926441010
10	10	150	30	60	2	1	9,8	7926441015
12	12	100	25	50	2	1	11,8	7926441210
12	12	150	40	80	2	1	11,8	7926441215
16	16	100	25	50	2	1,5	15,8	7926441610
16	16	150	40	80	2	1,5	15,8	7926441615

792 645

HSC-Radiusfräser VHM+Diamant Lang + Überlang
Carbide HSC Radius End Mills+Diamond Long + Extra Long



- Grafit und Grünlinge
- Lange und überlange Ausführung
- Freistellung nach der Schneide
- Stirnradius für Kopierarbeiten
- Oberfläche Diamant beschichtet
- Graphite and greens
- Long and extra long series
- Back clearance after primary edge
- Radius for copying operations
- With diamond coating

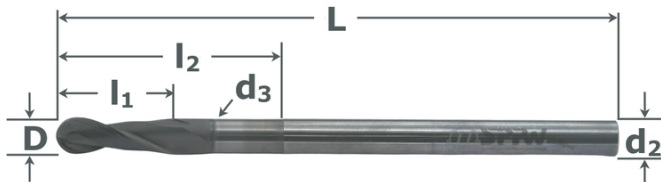

VHM	DIA Graph
z:2	DIN 6535HA
L lang	Grafit

ØD h10	Ød2 h6	L	l1	l2	z	Ød3	Art. No.
2	3	50	6	12	2	1,9	7926450205
2	3	100	10	20	2	1,9	7926450210
3	3	60	8	16	2	2,9	7926450306
3	3	100	12	24	2	2,9	7926450310
4	4	60	10	20	2	3,8	7926450406
4	4	100	15	30	2	3,8	7926450410
5	5	60	12	24	2	4,8	7926450506
5	5	100	15	30	2	4,8	7926450510
6	6	75	20	40	2	5,8	7926450607
6	6	100	25	50	2	5,8	7926450610

ØD h10	Ød2 h6	L	l1	l2	z	Ød3	Art. No.
6	6	150	30	60	2	5,8	7926450615
8	8	75	20	40	2	7,8	7926450807
8	8	100	25	50	2	7,8	7926450810
8	8	150	30	60	2	7,8	7926450815
10	10	100	25	50	2	9,8	7926451010
10	10	150	30	60	2	9,8	7926451015
12	12	100	25	50	2	11,8	7926451210
12	12	150	40	80	2	11,8	7926451215
16	16	100	25	50	2	15,8	7926451610
16	16	150	40	80	2	15,8	7926451615

551 100

Einzahnfräser HSS-E für Kopiermaschinen HSS-E HSC Single Flute End Mills



- Leichtlegierungen und Kunststoffe
 - Fenster, Türen, Ladenbau
 - Rechtsschneidend mit Rechtsspirale
 - Zentrumschnitt zum Tauchen
 - Verstärkter Schaft 8mm
 - Oberfläche blank
- Für Elu, Haffner, Rotox und andere

- Light alloys and plastics
 - Windows, door and shop fronts
 - Right hand helix, right hand cutting
 - Center cutting for plunging
 - Reinforced shank 8mm
 - Bright finish
- For Élu, Haffner, Rotox and others

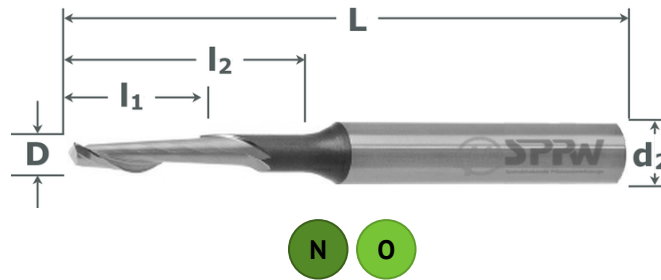

HSS E05	blank
Typ W	z:1
Shaft 8mm	

ØD k10	d2 h6	L	l1	l2	Art. No.
3	8	60	12		5511000300
4	8	60	12		5511000400
5	8	80	18	35	5511000500
5	8	60	18		5511000501
5	8	60	16	45	5511000502
6	8	60	14		5511000600

ØD k10	d2 h6	L	l1	l2	Art. No.
8	8	80	14		5511000800
8	8	80	14	54	5511000801
8	8	120	14		5511000802
10	8	80	14		5511001000
12	8	80	14		5511001200

— INFO



Spezielle Anwendungen

Für besondere Bearbeitungsaufgaben werden oft sehr spezielle Werkzeuge benötigt. Wir haben das Know-How und die Werkzeuge. Beispielsweise zum Kanten von Verbundplatten in der Werbetechnik oder Fräsbearbeitung von Baustoffen wie Gasbeton oder Granit in der Architektur.

Special Applications

Often very special tools are required for special machining tasks. We have the know-how and the tools. For example, for edging composite panels in advertising technology or milling building materials such as aerated concrete or granite in architecture.

552 480**Schaftfräser HSS-E08 - Leichtlegierungen**
HSS-E08 End Mills - Light Alloys

- Leichtlegierungen und NE-Metalle
- Weite Spanräume für gute Spanabfuhr
- Zentrumschnitt zum Tauchen
- Kurze Ausführung mit 40° Spirale
- Schaft DIN 1835 B mit Spannfläche
- Oberfläche blank

- Light alloys and non-ferrous metals
- Wide flutes for good chip evacuation
- Center cutting for plunging
- Short series with 40° helix
- Flatted shank DIN 1835 B
- Bright finish

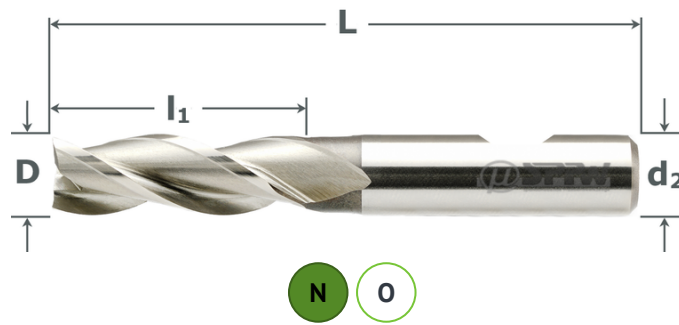

HSS E08	blank
DIN 844K	Typ W
z: 3	DIN 1835B

ØD h10	Ød2 h6	L	l1	z	Art. No.
2	6	51	7	3	5524800200
3	6	52	8	3	5524800300
4	6	55	11	3	5524800400
5	6	57	13	3	5524800500
6	6	57	13	3	5524800600
7	10	66	16	3	5524800700
8	10	69	19	3	5524800800

ØD h10	Ød2 h6	L	l1	z	Art. No.
9	10	69	19	3	5524800900
10	10	72	22	3	5524801000
12	12	83	26	3	5524801200
14	12	83	26	3	5524801400
16	16	92	32	3	5524801600
18	16	92	32	3	5524801800
20	20	104	38	3	5524802000

552 580**Schaftfräser HSS-E08 Lang - Leichtlegierungen**
HSS-E08 End Mills Long Series Light Alloys

- Leichtlegierungen und NE-Metalle
- Weite Spanräume für gute Spanabfuhr
- Zentrumschnitt zum Tauchen
- Lange Ausführung mit 40° Spirale
- Schaft DIN 1835 B mit Spannfläche
- Oberfläche blank

- Light alloys and non-ferrous metals
- Wide flutes for good chip evacuation
- Center cutting for plunging
- Long series with 40° helix
- Flatted shank DIN 1835 B
- Bright finish

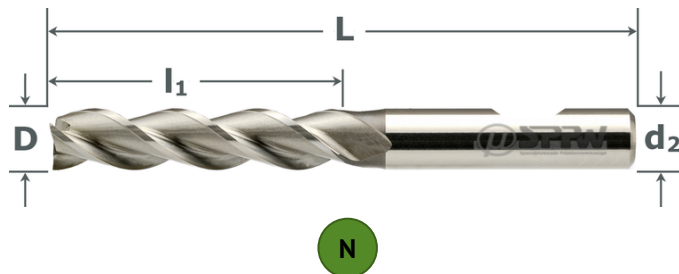

HSS E08	blank
DIN 844L	Typ W
z:3	DIN 1835B

ØD k10	Ød2 h6	L	l1	z	Art. No.
6	6	68	24	3	5525800600
8	10	82	88	3	5525800800
10	10	95	45	3	5525801000
12	12	110	53	3	5525801200

ØD k10	Ød2 h6	L	l1	z	Art. No.
14	12	110	53	3	5525801400
16	16	123	63	3	5525801600
18	16	123	63	3	5525801800
20	20	141	75	3	5525802000



[DE] **Hartmetall Fräsen**
[EN] **Carbide Milling**













passion for precision
[Leidenschaft für Präzision]



HPC Fräser VHM - REQUIN

Carbide HPC Milling Cutters - REQUIN



Art.No./Page

● ● ● ○ ○		VHM	X Cut	DIN 6527	HPC 35J38	z:4	DIN 6535HB	Fase ch:45°	757 411 Seite J 1
● ● ●		VHM	X Cut	DIN 6527K	HPC 35J38	z:4	DIN 6535HB	Fase ch:45°	757 311 Seite J 1
● ● ●		VHM	X Cut	L lang	HPC 35J38	z:4	DIN 6535HB	Fase ch:45°	757 511 Seite J 1
● ● ●		VHM	X Cut	DIN 6527	HPC 35J38	z:4	DIN 6535HB	sharp	757 412 Seite J 2
● ● ●		VHM	X Cut	DIN 6527K	HPC 35J38	z:4	DIN 6535HB	sharp	757 312 Seite J 2
● ● ●		VHM	X Cut	L lang	HPC 35J38	z:4	DIN 6535HB	sharp	757 512 Seite J 2
● ● ●		VHM	X Cut	DIN 6527	HPC 35J38	z:4	DIN 6535HB	ER Torus	757 414 Seite J 3
● ● ●		VHM	X Cut	L lang	HPC 35J38	z:4	DIN 6535HB	ER Torus	757 514 Seite J 3
● ● ●		VHM	X Cut	DIN 6527	HPC 35J38	z:4	DIN 6535HB	NRF Profil	757 446 Seite J 4
● ● ●		VHM	X Cut	DIN 6527K	HPC 35J38	z:4	DIN 6535HB	NRF Profil	757 346 Seite J 4
● ● ●		VHM	X Cut	HPC 35J38	z:4	DIN 6535HB	L lang	NRF Profil	757 546 Seite J 4
● ● ●		VHM	X Cut	DIN 6527	HPC 35°	z:2	DIN 6535HB		757 445 Seite J 5
● ● ●		VHM	X Cut	DIN 6527K	HPC 35°	z:2	DIN 6535HB		757 345 Seite J 5

TDC Fräser VHM - TROCHOID

Carbide TDC Milling Cutters - TROCHOID



Art.No./Page

● ● ○ ○		VHM	X Cut	TDC 40°	z:5	DIN 6535HB	60 HRC	757 521 Seite J 6
○ ●		VHM	X Cut	TDC 40°	z:5	DIN 6535HB	Titan	757 531 Seite J 6

Tonnenfräser VHM

Carbide Barrel Milling Cutters

Art.No./Page

●		VHM	X Cut	Tonne barrel	z:4	DIN 6535HA	65 HRC	757 710 Seite J 7
●		VHM	X Cut	Tonne barrel	z:4	DIN 6535HA	65 HRC	757 720 Seite J 7

Hochleistungs-Fräser VHM

Carbide HPC End Mills

Art.No./Page

● ● ○ ○		VHM	X Cut	DIN 6527	HPC 35J38	z:4	DIN 6535HB	60 HRC	757 420 Seite J 8
● ● ○ ○		VHM	X Cut	DIN 6527	HPC 35J38	z:4	DIN 6535HB	60 HRC	757 424 Seite J 8
● ● ○ ○		VHM	X Cut	DIN 6527	HPC 35J38	z:4	DIN 6535HB	60 HRC	757 425 Seite J 9
● ● ○ ●		VHM	X Cut	DIN 6527	HPC 55°	z:4	DIN 6535HB	INOX	757 458 Seite J 9

HSC-Fräser VHM

Carbide HSC End Mills

Art.No./Page

● ● ● ●		VHM	X Cut	N 35°	z:2	DIN 6535HA	XL Radius	756 026 Seite J 5
● ● ● ●		VHM	X Cut	HSC-H 40°	z:2	DIN 6535HA	65 HRC	752 425 Seite J 10
● ● ● ●		VHM	X Cut	HSC-H 40°	z:2	DIN 6535HA	L lang 65 HRC	752 525 Seite J 10
● ● ● ●		VHM	X Cut	HSC-H 40°	z: 4-6	DIN 6535HA	ER Torus	756 424 Seite J 11
● ● ● ●		VHM	X Cut	HSC-H 40°	z: 4-6	DIN 6535HA	L lang ER Torus	756 524 Seite J 11
● ● ● ● ○		VHM	X Cut	N 30°	z:2	DIN 6535HA	L lang 260° Radius	752 555 Seite J 12

Universalfräser VHM

Carbide Universal End Mills

Art.No./Page

● ● ● ● ○		VHM	X Cut	Typ N	z:2	DIN 6535HA	sharp	672 000 Seite J 13
● ● ● ● ○		VHM	X Cut	Typ N	z:3	DIN 6535HA	sharp	673 000 Seite J 13
● ● ● ● ● ○		VHM	blank	Typ N	z:2	DIN 6535HA	XL	662 640 Seite J 14
● ● ● ● ● ○		VHM	blank	Typ N	z:4	DIN 6535HA	XL	664 640 Seite J 14



- Schrapp- und Schlichtbearbeitung
- Breites Einsatzspektrum
- Mit ungleicher Teilung 35°/38°
- Schutzfasen an den Schneidecken
- Freistellung nach der Schneide
- Oberfläche X.Cut beschichtet
- Roughing and finishing operations
- Extended field of applications
- Unequal helix 35°/38°
- Protective chamfers on cutting edges
- Back clearance after cutting edge
- With X.Cut coating

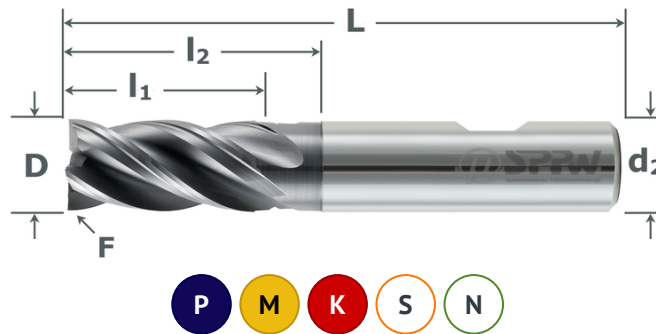

VHM	X Cut
DIN 6527	HPC 35 38
z:4	DIN 6535HB
Fase ch:45°	

757411 - kurz | short series

ØD h10	Ød2 h6	L	l1	l2	z	F ±0,05	Art. No.
3	6	57	8	12	4	0,15	7574110300
4	6	57	11	15	4	0,15	7574110400
5	6	57	13	17	4	0,15	7574110500
6	6	57	13	21	4	0,15	7574110600
8	8	63	19	27	4	0,25	7574110800

ØD h10	Ød2 h6	L	l1	l2	z	F ±0,05	Art. No.
10	10	72	22	32	4	0,25	7574111000
12	12	83	26	38	4	0,35	7574111200
16	16	92	32	44	4	0,35	7574111600
20	20	104	38	54	4	0,35	7574112000

757311 - extra-kurz | stub series

ØD h10	Ød2 h6	L	l1	l2	z	F ±0,05	Art. No.
3	6	50	5	--	4	0,15	7573110300
4	6	54	5	--	4	0,15	7573110400
5	6	54	9	--	4	0,15	7573110500
6	6	54	10	--	4	0,15	7573110600
8	8	58	12	--	4	0,25	7573110800

ØD h10	Ød2 h6	L	l1	l2	z	F ±0,05	Art. No.
10	10	66	14	--	4	0,25	7573111000
12	12	73	16	--	4	0,35	7573111200
16	16	82	22	--	4	0,35	7573111600
20	20	92	26	--	4	0,35	7573112000

757511 - lang | long series

ØD h10	Ød2 h6	L	l1	l2	z	F ±0,05	Art. No.
3	6	70	7	15	4	0,15	7575110300
4	6	70	11	20	4	0,15	7575110400
5	6	70	13	25	4	0,15	7575110500
6	6	70	13	30	4	0,15	7575110600
8	8	80	19	40	4	0,25	7575110800

ØD h10	Ød2 h6	L	l1	l2	z	F ±0,05	Art. No.
10	10	94	22	50	4	0,25	7575111000
12	12	109	26	64	4	0,35	7575111200
16	16	132	32	80	4	0,35	7575111600
20	20	154	38	100	4	0,35	7575112000



- Schrupp- und Schlichtbearbeitung
- Breites Einsatzspektrum
- Mit ungleicher Teilung 35°/38°
- Scharfe Schneidecken
- Freistellung nach der Schneide
- Oberfläche X.Cut beschichtet

- Roughing and finishing operations
- Extended field of applications
- Unequal helix 35°/38°
- Sharp cutting edges
- Back clearance after cutting edge
- With X.Cut coating

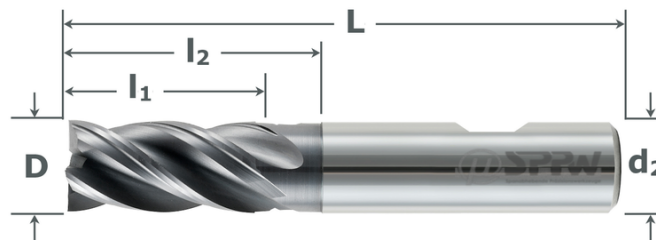

VHM	X Cut
DIN 6527	HPC 35 38
z:4	DIN 6535HB
sharp	

757412 - kurz | short series

ØD h10	Ød2 h6	L	l1	l2	z	Art. No.
6	6	57	13	21	4	7574120600
8	8	63	19	27	4	7574120800
10	10	72	22	32	4	7574121000

ØD h10	Ød2 h6	L	l1	l2	z	Art. No.
12	12	83	26	38	4	7574121200
16	16	92	32	44	4	7574121600
20	20	104	38	54	4	7574122000

757312 - extra-kurz | stub series

ØD h10	Ød2 h6	L	l1	l2	z	Art. No.
6	6	54	10	--	4	7573120600
8	8	58	12	--	4	7573120800
10	10	66	14	--	4	7573121000

ØD h10	Ød2 h6	L	l1	l2	z	Art. No.
12	12	73	16	--	4	7573121200
16	16	82	22	--	4	7573121600
20	20	92	26	--	4	7573122000

757512 - lang | long series

ØD h10	Ød2 h6	L	l1	l2	z	Art. No.
6	6	70	13	30	4	7575120600
8	8	80	19	40	4	7575120800
10	10	94	22	50	4	7575121000

ØD h10	Ød2 h6	L	l1	l2	z	Art. No.
12	12	109	26	64	4	7575121200
16	16	132	32	80	4	7575121600
20	20	154	38	100	4	7575122000



INFO

- Ultra-Feinstkorn-Hartmetall
- TiAlCrN-Beschichtung
- Ungleiche Teilung 35°/38°
- Schutzfase, Eckradius oder scharfe Schneide

- Ultra-fine grain carbide
- TiAlCrN coating
- Unequal Helix 35°/38°
- Protection chamfer, corner radius or sharp edge





- Mit ungleicher Teilung 35°/38°
- Eckradius für Kopierarbeiten
- andere Radien auf Anfrage
- Freistellung nach der Schneide
- Oberfläche X.Cut beschichtet
- Unequal helix 35°/38°
- Corner radius for copying operations
- other radii on request
- Back clearance after cutting edge
- With X.Cut coating

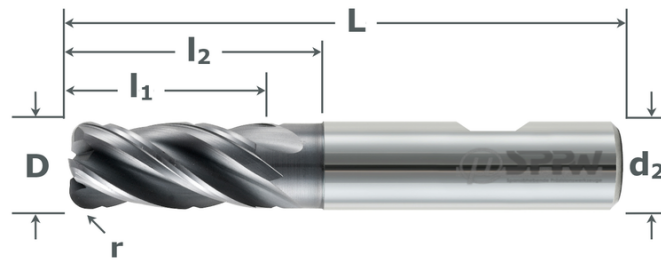

VHM	X Cut
DIN 6527	HPC 35 38
z:4	DIN 6535HB
ER Torus	

757414 - kurz | short series

ØD h10	Ød2 h6	L	l1	l2	z	r ±0,05	Art. No.
3	6	57	8	12	4	0,3	7574140303
3	6	57	8	12	4	0,5	7574140305
4	6	57	11	15	4	0,5	7574140405
4	6	57	11	15	4	1	7574140410
5	6	57	13	17	4	0,5	7574140505
5	6	57	13	17	4	1	7574140510
6	6	57	13	21	4	0,5	7574140605
6	6	57	13	21	4	1	7574140610

ØD h10	Ød2 h6	L	l1	l2	z	r ±0,05	Art. No.
8	8	63	19	27	4	0,5	7574140805
8	8	63	19	27	4	1	7574140810
10	10	72	22	32	4	0,5	7574141005
10	10	72	22	32	4	1	7574141010
12	12	83	26	38	4	0,5	7574141205
12	12	83	26	38	4	1	7574141210
16	16	92	32	44	4	1	7574141610
20	20	104	38	54	4	1	7574142010

757514 - lang | long series

ØD h10	Ød2 h6	L	l1	l2	z	r ±0,05	Art. No.
3	6	70	8	15	4	0,3	7575140303
3	6	70	8	15	4	0,5	7575140305
4	6	70	11	20	4	0,5	7575140405
4	6	70	11	20	4	1	7575140410
5	6	70	13	25	4	0,5	7575140505
5	6	70	13	25	4	1	7575140510
6	6	70	13	30	4	0,5	7575140605
6	6	70	13	30	4	1	7575140610

ØD h10	Ød2 h6	L	l1	l2	z	r ±0,05	Art. No.
8	8	80	19	40	4	0,5	7575140805
8	8	80	19	40	4	1	7575140810
10	10	94	22	50	4	0,5	7575141005
10	10	94	22	50	4	1	7575141010
12	12	109	26	64	4	0,5	7575141205
12	12	109	26	64	4	1	7575141210
16	16	132	32	80	4	1	7575141610
20	20	154	38	100	4	1	7575142010



- HPC-Schruppbearbeitung -NRf-Profil
- Breites Anwendungsfeld
- Mit ungleicher Teilung 35°/38°
- Oberfläche X.Cut beschichtet
- HPC-Roughing operations - NRf-Profile
- Broad Field of application
- Unequal helix 35°/38°
- With X.Cut coating

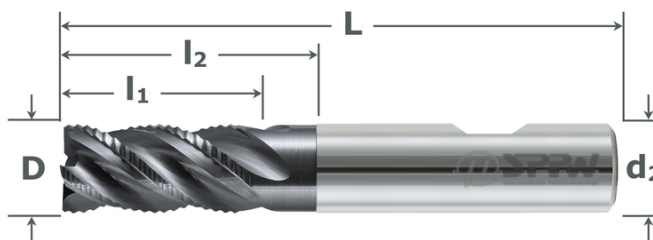

VHM	X Cut
DIN 6527	HPC 35138
z:4	DIN 6535HB
NRf Profil	

757446 - kurz | short series

ØD h10	Ød2 h6	L	l1	l2	z	Art. No.
3	6	57	8	12	4	7574460300
4	6	57	11	15	4	7574460400
5	6	57	13	17	4	7574460500
6	6	57	13	21	4	7574460600

ØD h10	Ød2 h6	L	l1	l2	z	Art. No.
8	8	63	19	27	4	7574460800
10	10	72	22	32	4	7574461000
16	16	92	32	44	4	7574461600
20	20	104	38	54	4	7574462000

757346 - extra-kurz | stub series

ØD h10	Ød2 h6	L	l1	l2	z	Art. No.
3	6	50	5	--	4	7573460300
4	6	54	8	--	4	7573460400
5	6	54	9	--	4	7573460500
6	6	54	10	--	4	7573460600
8	8	58	12	--	4	7573460800

ØD h10	Ød2 h6	L	l1	l2	z	Art. No.
10	10	66	14	--	4	7573461000
12	12	73	16	--	4	7573461200
16	16	82	22	--	4	7573461600
20	20	92	26	--	4	7573462000

757546 - lang | long series

ØD h10	Ød2 h6	L	l1	l2	z	Art. No.
3	6	70	8	15	4	7575460300
4	6	70	11	20	4	7575460400
5	6	70	13	25	4	7575460500
6	6	70	13	30	4	7575460600
8	8	80	19	40	4	7575460800

ØD h10	Ød2 h6	L	l1	l2	z	Art. No.
10	10	94	22	50	4	7575461000
12	12	109	26	64	4	7575461200
16	16	132	32	80	4	7575461600
20	20	154	38	100	4	7575462000

— INFO

- Ultra-Feinstkorn-Hartmetall
- TiAlCrN-Beschichtung
- Ungleiche Teilung 35°/38°
- Feine NR-Kordelverzahnung
- 45° Schutzfase an der Schneide
- Ultra-fine grain carbide
- TiAlCrN coating
- Unequal Helix 35°/38°
- Medium pitch roughing profile
- 45° protection chamfer



HPC Radius

HPC-Radiusfräser VHM+X.Cut 2 Schneiden Carbide HPC Copying Cutters X.Cut 2 Flutes



- HPC-Kopierbearbeitung
- Breites Anwendungsfeld
- Stirnradius, zentrumschneidend
- Oberfläche X.Cut beschichtet
- HPC-copying operations
- Broad Field of application
- Radius, center cutting
- With X.Cut coating

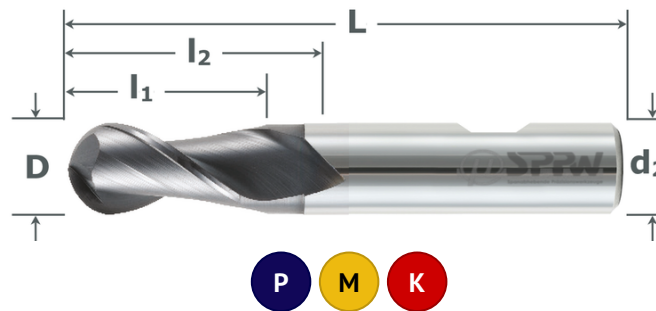

VHM	X Cut
DIN 6527	HPC 35°
z:2	DIN 6535HB

757445 - kurz | short series

ØD h10	Ød2 h6	L	l1	l2	z	Art. No.	ØD h10	Ød2 h6	L	l1	l2	z	Art. No.
3	6	57	8	12	2	7574450300	10	10	72	22	32	2	7574451000
4	6	57	11	15	2	7574450400	12	12	83	26	38	2	7574451200
5	6	57	13	17	2	7574450500	16	16	92	32	44	2	7574451600
6	6	57	13	21	2	7574450600	20	20	104	38	54	2	7574452000
8	8	63	19	27	2	7574450800							

757345 - extra-kurz | stub series

ØD h10	Ød2 h6	L	l1	l2	z	Art. No.	ØD h10	Ød2 h6	L	l1	l2	z	Art. No.
3	6	50	5	--	2	7573450300	10	10	66	14	--	2	7573451000
4	6	54	8	--	2	7573450400	12	12	73	16	--	2	7573451200
5	6	54	9	--	2	7573450500	16	16	82	22	--	2	7573451600
6	6	54	10	--	2	7573450600	20	20	92	26	--	2	7573452000
8	8	58	12	--	2	7573450800							

756 026

Radiusfräser VHM+X.Cut Überlang Carbide Radius End Mills Extra Long Series



- Kopierbearbeitung
- Überlange Ausführung mit Stirnradius
- Glatter Schaft DIN 6535 HA
- Oberfläche X.Cut beschichtet
- Abweichende Längen auf Anfrage
- HSC copy milling operations
- Extra long series with radius
- Straight shank DIN 6535 HA
- With X.Cut coating
- Other lengths available on request

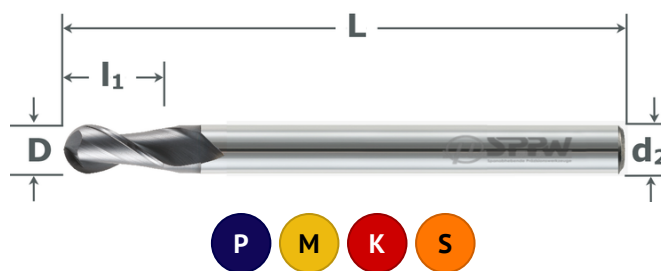

VHM	X Cut
N 35°	z:2
DIN 6535HA	XL Radius

ØD -0,05	Ød2 h6	L	l1	z	Art. No.	ØD -0,05	Ød2 h6	L	l1	z	Art. No.
2	2	80	3	2	7560260208	8	8	160	12	2	7560260816
3	3	80	4,5	2	7560260308	10	10	100	15	2	7560261010
4	4	100	6	2	7560260410	10	10	160	15	2	7560261016
5	5	100	7,5	2	7560260510	12	12	125	18	2	7560261212
6	6	100	9	2	7560260610	12	12	160	18	2	7560261216
6	6	160	9	2	7560260616	16	16	160	24	2	7560261616
8	8	100	12	2	7560260810	20	20	160	30	2	7560262016

757 521

TDC-Fräser VHM+X.Cut 5 Schneiden - Multiple Spanbrecher
Carbide Trochoidal Cutter X.Cut 5 Flutes - Chip Breakers



- Entwickelt zum Trochoidfräsen
- 40° Spirale mit Spanbrecher
- Gehärtete Stähle, Ni/Co-Legierungen
- Schutzfase an den Schneidecken
- Freistellung nach der Schneide
- Oberfläche X.Cut beschichtet

- Designed for trochoidal milling
- Hardened steels and Ni/Co-alloys
- 40° helix with chip breaker
- Protective chamfer on cutting edges
- Back clearance after cutting edge
- With X.Cut coating

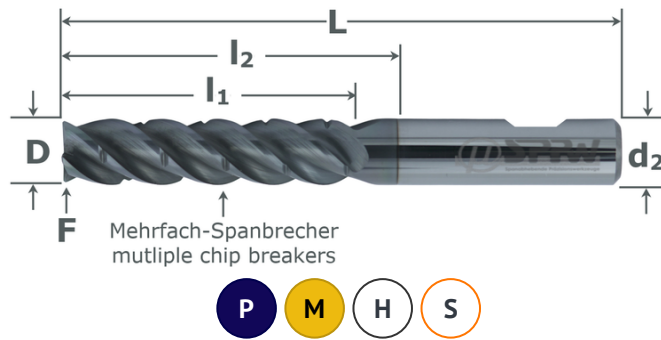

VHM	X Cut
TDC 40°	z:5
DIN 6535HB	60 HRC

ØD h9	Ød2 h6	L	l1	l2	z	Art. No.	ØD h9	Ød2 h6	L	l1	l2	z	Art. No.
6	6	62	18	25	5	7575210600	12	12	93	36	45	5	7575211200
8	8	68	24	30	5	7575210800	16	16	108	48	55	5	7575211600
10	10	80	30	35	5	7575211000	20	20	126	60	70	5	7575212000

757 531

TDC-Fräser VHM+X.Cut 5 Schneiden - Titan
Carbide Trochoidal Cutter X.Cut 5 Flutes - Titanium



- Entwickelt zum Trochoidfräsen
- 40° Spirale ohne Spanbrecher
- Titanlegierungen, gehärtete Stähle
- Schutzfase an den Schneidecken
- Freistellung nach der Schneide
- Oberfläche X.Cut beschichtet

- Designed for trochoidal milling
- Titanium alloys, hardened steels
- 40° helix with chip breaker
- Protective chamfer on cutting edges
- Back clearance after cutting edge
- With X.Cut coating

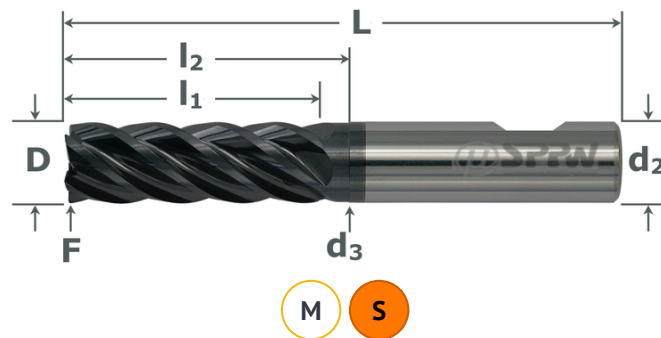

VHM	X Cut
TDC 40°	z:5
DIN 6535HB	Titan

ØD h9	Ød2 h6	L	l1	l2	z	Art. No.	ØD h9	Ød2 h6	L	l1	l2	z	Art. No.
6	6	62	18	25	5	7575310600	12	12	93	36	45	5	7575311200
8	8	68	24	30	5	7575310800	16	16	108	48	55	5	7575311600
10	10	80	30	35	5	7575311000	20	20	126	60	70	5	7575312000

— INFO —

TDC - Trochoidal Dynamic Cutting

Hochdynamisches Fräsen mit hohen Schnittgeschwindigkeiten und kontrollierten Eingriffstiefen. CAM-optimierte Werkzeugwege führen in Verbindung mit variabler Zustellung und dynamischen Vorschubgeschwindigkeiten zu einer optimalen, kontrollierten Spandicke und damit zu optimalen Schnittbedingungen.

- Volle Eingriffstiefe kann genutzt werden
- Bessere Verteilung der Schnittkräfte
- Drastisch erhöhten Zeitspanvolumen
- Deutlich geringere Bearbeitungszeit
- Längere Lebensdauer des Fräswerkzeugs

Highly dynamic milling with high cutting speeds and controlled depths of cut. CAM-optimized toolpaths, in combination with variable infeed and dynamic feed rates, lead to an optimal, controlled chip thickness and thus to optimal cutting conditions.

- Full depth of cut can be used
- Better distribution of cutting forces
- Drastically increased metal removal rate
- Significantly reduced machining time
- Longer service life of the milling tool

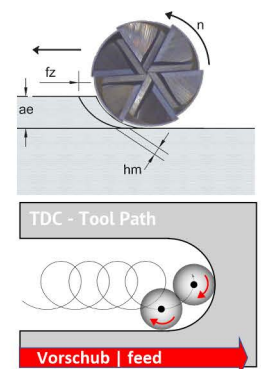

757 710

Tonnenfräser VHM+X.Cut - Konische Form
Carbide Barrell Milling Cutter X.Cut - Conical



- Schlichtbearbeitung an Freiformen
- Hervorragende Oberflächengüten
- Kurze Bearbeitungszeiten
- Konische Form
- Fräsmaschinen mit CAD/CAM
- Lieferzeit auf Anfrage
- Finishing on free-form surfaces
- Excellent surface finish
- Short machining times
- Conical form
- Milling machines with CAD/CAM
- Delivery time on request

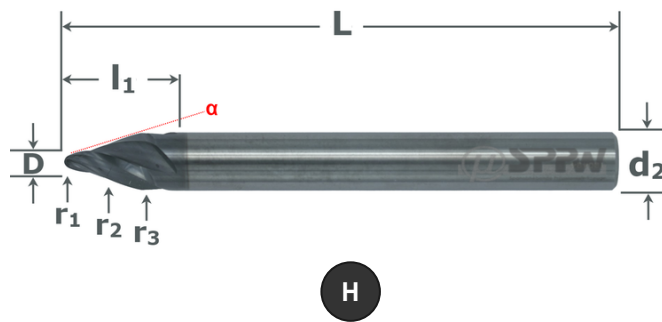

VHM	X Cut
Tonne barrel	z:4
DIN 6535HA	65 HRC

ØD h10	Ød2 h6	L	l1	r1	r2	r3	α	Art. No.	ØD h10	Ød2 h6	L	l1	r1	r2	r3	α	Art. No.
2	8	75	10	1	300	1	18	7577100218	6	16	120	12	3	800	3	28	7577100628
4	12	100	14	2	450	2	18	7577100418	8	16	120	16	4	1200	4	18	7577100818
6	16	120	18	3	1200	3	18	7577100618	8	16	120	11	4	800	4	28	7577100828

757 720

Tonnenfräser VHM+X.Cut - Tangentiale Form
Carbide Barrell Milling Cutter X.Cut - Tangential



- Schlichtbearbeitung an Freiformen
- Hervorragende Oberflächengüten
- Kurze Bearbeitungszeiten
- Tangentiale Form
- Fräsmaschinen mit CAD/CAM
- Lieferzeit auf Anfrage
- Finishing on free-form surfaces
- Excellent surface finish
- Short machining times
- Tangential form
- Milling machines with CAD/CAM
- Delivery time on request

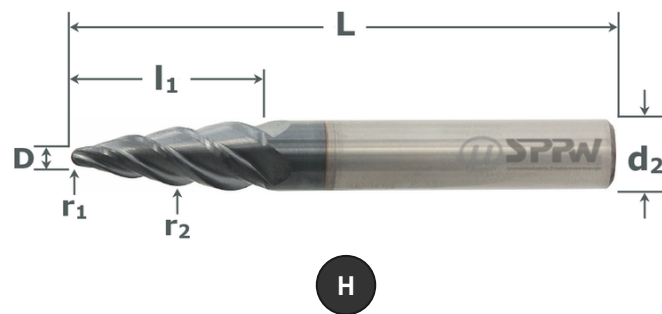

VHM	X Cut
Tonne barrel	z:4
DIN 6535HA	65 HRC

ØD h10	Ød2 h6	L	l1	r1	r2	Art. No.	ØD h10	Ød2 h6	L	l1	r1	r2	Art. No.
2	8	70	24	1	95	7577200208	6	16	105	30	3	90	7577200616
4	10	82	28	2	90	7577200410							

— INFO —

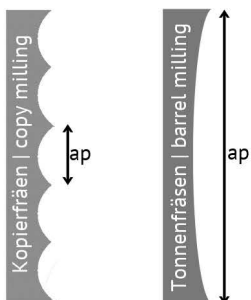

Tonnenfräsen
 ist ein Bearbeitungsverfahren auf 5-Achs CNC-Maschinen und hat viele Vorteile im Vergleich mit dem klassischen Kopierfräsen:

- Große Zeilensprünge (ap)
- Bessere Oberflächengüten
- Hohe Prozesssicherheit
- Kürzere Bearbeitungszeiten
- Höhere Produktivität

Barrel milling
 is a machining strategy on 5-axis CNC machines. It has many advantages over the classic copy milling.

- Large line jumps
- Better surface finishes
- High process reliability
- Shorter machining times
- Higher productivity

757 420

Hochleistungsfräser VHM+X.Cut Ungleiche Teilung
Carbide High Performance End Mills+X.Cut Unequal Helix



- Schrupp- und Schlichtbearbeitung
- Für zähe und hochharte Werkstoffe
- Mit ungleicher Teilung 35°/38°
- Schneide mit Schutzfase 45°
- Freistellung nach der Schneide
- Oberfläche X.Cut beschichtet

- Roughing and finishing operations
- Extremely hard, ductile materials
- Unequal helix
- Protective chamfer/radius on edge
- Back clearance after cutting edge
- With X.Cut coating

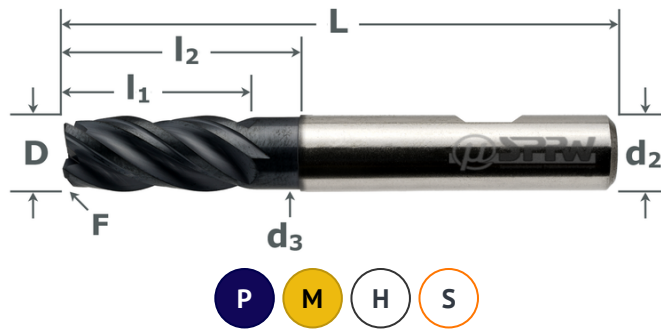

VHM	X Cut
DIN 6527	HPC 35 38
z:4	DIN 6535HB
60 HRC	

ØD h9	Ød2 h6	L	l1	l2	z	F	Ød3	Art. No.
3	6	57	8	15	4	0,1	2,8	7574200300
4	6	57	11	17	4	0,1	3,5	7574200400
5	6	57	13	19	4	0,2	4,5	7574200500
6	6	57	13	21	4	0,2	5,5	7574200600
8	8	63	19	26	4	0,2	7,5	7574200800

ØD h9	Ød2 h6	L	l1	l2	z	F	Ød3	Art. No.
10	10	72	22	30	4	0,25	9,5	7574201000
12	12	83	26	37	4	0,3	11,5	7574201200
16	16	92	32	42	4	0,4	15,5	7574201600
20	20	104	38	50	4	0,5	19,5	7574202000

757 424

Hochleistungsfräser VHM+X.Cut mit Eckradius
Carbide High Performance End Mills+X.Cut Corner Radius



- Schrupp- und Schlichtbearbeitung
- Für zähe und hochharte Werkstoffe
- Mit ungleicher Teilung 35°/38°
- Schneide mit Eckenradius
- Freistellung nach der Schneide
- Oberfläche X.Cut beschichtet

- Roughing and finishing operations
- Extremely hard, ductile materials
- Unequal helix 35°/38°
- Protective chamfer/radius on edge
- Back clearance after cutting edge
- With X.Cut coating



VHM	X Cut
DIN 6527	HPC 35 38
z:4	DIN 6535HB
60 HRC	

ØD h9	Ød2 h6	L	l1	z	r Radius	Art. No.
4	6	57	11	4	0,5	7574240405
4	6	57	11	4	01,0	7574240410
6	6	57	13	4	0,5	7574240605
6	6	57	13	4	1,0	7574240610
8	8	63	19	4	0,5	7574240805
8	8	63	19	4	1,0	7574240810
10	10	72	22	4	0,5	7574241005

ØD h9	Ød2 h6	L	l1	z	r Radius	Art. No.
10	10	72	22	4	1,0	7574241010
12	12	83	26	4	0,5	7574241205
12	12	83	26	4	1,0	7574241210
16	16	92	32	4	2,0	7574241620
20	20	104	38	4	1,0	7574242010
20	20	104	38	4	2,0	7574242020

757 425

Hochleistungs-Radiusfräser VHM+X.Cut Ungleiche Teilung
Carbide High Performance Radius End Mills+X.Cut Unequal Helix



- Schrapp- und Schlichtbearbeitung
- Zäh- und hochharte Werkstoffe
- Mit ungleicher Teilung 35°/38°
- Stirnradius, zentrumschneidend
- Oberfläche X.Cut beschichtet
- Roughing and finishing operations
- Extremely hard and ductile materials
- Unequal helix 35°/38°
- Radius, center cutting
- With X.Cut coating

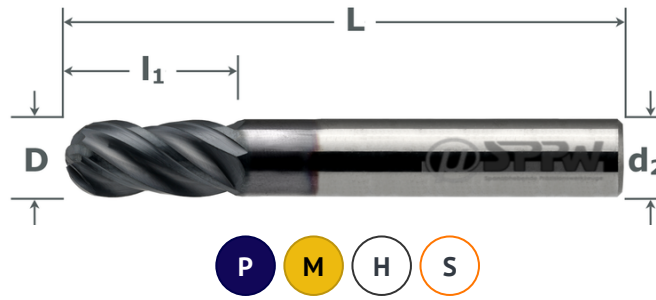

VHM	X Cut
DIN 6527	HPC 35 38
z:4	DIN 6535HB
60 HRC	

ØD h10	Ød2 h6	L	l1	z	Art. No.
3	6	57	8	4	7574250300
4	6	57	10	4	7574250400
5	6	57	13	4	7574250500
6	6	57	13	4	7574250600
8	8	63	16	4	7574250800

ØD h10	Ød2 h6	L	l1	z	Art. No.
10	10	72	22	4	7574251000
12	12	83	26	4	7574251200
16	16	92	32	4	7574251600
20	20	104	32	4	7574252000

757 458

Hochleistungs-Schlichtfräser VHM+X.Cut
Carbide High Performance Finishing End Mills+X.Cut



- Schlichtfräser für rostfreie Stähle
- 55° Spirale, ungleiche Stirnteilung
- Hohe Laufruhe und beste Oberflächen
- Schutzfasen an den Schneidecken
- Freistellung nach der Schneide
- Oberfläche X.Cut beschichtet
- Finishing operation in stainless steel
- 55° helix with unequal spacing
- Vibration free milling, best finish
- Protective chamfers on edges
- Back clearance after cutting edge
- With X.Cut coating

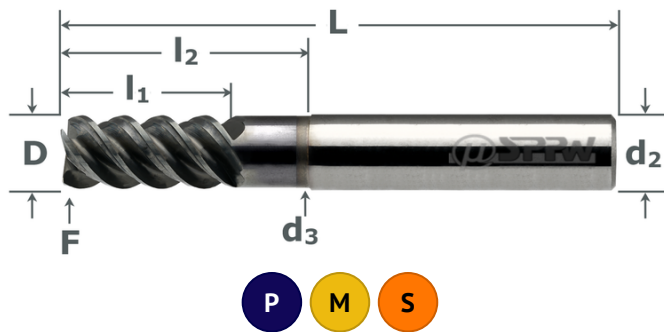

VHM	X Cut
DIN 6527	HPC 55°
z:4	DIN 6535HB
INOX	

ØD h9	Ød2 h6	L	l1	l2	z	Ød3	Art. No.
3	6	57	8	15	4	2,8	7574580300
4	6	57	11	17	4	3,8	7574580400
5	6	57	13	19	4	4,8	7574580500
6	6	57	13	21	4	5,8	7574580600
8	8	63	19	27	4	7,8	7574580800

ØD h9	Ød2 h6	L	l1	l2	z	Ød3	Art. No.
10	10	72	22	32	4	9,8	7574581000
12	12	83	26	38	4	11,8	7574581200
16	16	92	32	44	4	15,8	7574581600
18	18	92	32	44	4	17,8	7574581800
20	20	104	38	54	4	19,8	7574582000



- HSC-Kopierbearbeitung
- Gehärtete Stähle bis 65 HRC
- Kurze Ausführung mit Stirnradius
- Glatter Schaft DIN 6535 HA
- Oberfläche X.Cut beschichtet
- HSC copy milling operations
- Hardened steels up to 65 HRC
- Short series, radius
- Straight shank DIN 6535 HA
- With X.Cut coating

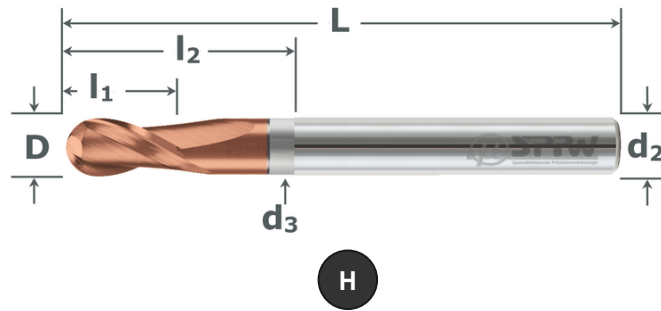

VHM	X Cut
HSC-H 40°	z:2
DIN 6535HA	65 HRC

752425 - kurz | short series

ØD h10	Ød2 h6	L	l1	l2	z	R ±0,01	Ød3	Art. No.	ØD h10	Ød2 h6	L	l1	l2	z	R ±0,01	Ød3	Art. No.
2	6	57	3	7	2	1	1,9	7524250200	6	6	57	7	19	2	3	5,5	7524250600
3	6	57	4	10	2	1,5	2,8	7524250300	8	8	100	9	25	2	4	7,4	7524250800
4	6	57	5	13	2	2	3,7	7524250400	10	10	72	11	31	2	5	9,2	7524251000
5	6	57	6	16	2	2,5	4,6	7524250500	12	12	83	13	37	2	6	11	7524251200

752525 - lang | long series

ØD h10	Ød2 h6	L	l1	l2	z	R ±0,01	Ød3	Art. No.	ØD h10	Ød2 h6	L	l1	l2	z	R ±0,01	Ød3	Art. No.
2	6	80	3	13	2	1	1,9	7525250200	6	6	80	7	37	2	3	5,5	7525250600
3	6	80	4	19	2	1,5	2,8	7525250300	8	8	63	9	49	2	4	7,4	7525250800
4	6	80	5	25	2	2	3,7	7525250400	10	10	100	11	61	2	5	9,2	7525251000
5	6	80	6	31	2	2,5	4,6	7525250500	12	12	120	13	73	2	6	11	7525251200

— INFO —

- Ultra-Feinstkorn-Hartmetall
- Hochverschleißfeste TiSiN-Beschichtung
- Präzise Schafttoleranz h5
- Negativer Schnittwinkel
- Erhöhte Kerndicke
- Radiustoleranz ±0,01
- Ultra-fine grain carbide
- Highly wear-resistant TiSiN coating
- Precise shank tolerance h5
- Negative cutting angle
- Increased core thickness
- Radius tolerance ±0.01

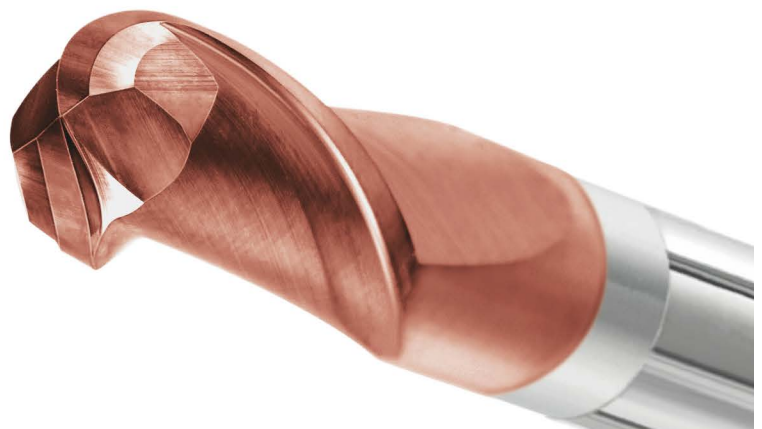



- HSC/HHC-Kopierbearbeitung
- Gehärtete Stähle bis 65 HRC
- Ausführung mit Eckenradius
- Glatter Schaft DIN 6535 HA
- Oberfläche X.Cut beschichtet
- HSC/HHC copy milling operations
- Hardened steels up to 65 HRC
- Short series with corner radius
- Straight shank DIN 6535 HA
- With X.Cut coating

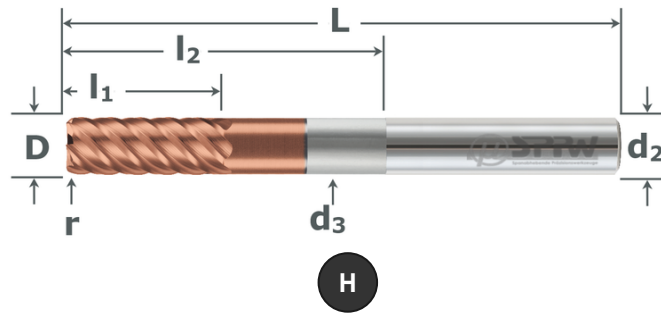

VHM	X Cut
HSC-H 40°	z: 4-6
DIN 6535HA	ER Torus

756424 - kurz | short series

ØD h10	Ød2 h6	L	l1	l2	z	r +0,015	Ød3	Art. No.	ØD h10	Ød2 h6	L	l1	l2	z	r +0,015	Ød3	Art. No.
2	6	57	3	7	4	0,2	1,9	7564240202	5	6	57	6	16	4	1	4,6	7564240510
2	6	57	3	7	4	0,4	1,9	7564240204	6	6	57	7	19	6	0,5	5,5	7564240605
3	6	57	4	10	4	0,3	2,8	7564240303	6	6	57	7	19	6	1	5,5	7564240610
3	6	57	4	10	4	0,6	2,8	7564240306	8	8	63	9	25	6	0,5	7,4	7564240805
4	6	57	5	13	4	0,4	3,7	7564240404	8	8	63	9	25	6	1	7,4	7564240810
4	6	57	5	13	4	0,8	3,7	7564240408	10	10	72	11	31	6	1	9,2	7564241010
5	6	57	6	16	4	0,5	4,6	7564240505	12	12	83	13	37	6	1	11	7564241210

756524 - lang | long series

ØD h10	Ød2 h6	L	l1	l2	z	r +0,015	Ød3	Art. No.	ØD h10	Ød2 h6	L	l1	l2	z	r +0,015	Ød3	Art. No.
2	6	80	3	13	4	0,2	1,9	7565240202	5	6	80	6	31	4	1	4,6	7565240510
2	6	80	3	13	4	0,4	1,9	7565240204	6	6	80	7	37	6	0,5	5,5	7565240605
3	6	80	4	19	4	0,3	2,8	7565240303	6	6	80	7	37	6	1	5,5	7565240610
3	6	80	4	19	4	0,6	2,8	7565240306	8	8	100	9	49	6	0,5	7,4	7565240805
4	6	80	5	25	4	0,4	3,7	7565240404	8	8	100	9	49	6	1	7,4	7565240810
4	6	80	5	25	4	0,8	3,7	7565240408	10	10	100	11	61	6	1	9,2	7565241010
5	6	80	6	31	4	0,5	4,6	7565240505	12	12	120	13	73	6	1	11	7565241210

— INFO

- Ultra-Feinstkorn-Hartmetall
- Hochverschleißfeste TiSiN-Beschichtung
- Präzise Schafttoleranz h5
- Negativer Schnittwinkel
- Erhöhte Kerndicke
- Radiustoleranz +0,015
- Ultra-fine grain carbide
- Highly wear-resistant TiSiN coating
- Precise shank tolerance h5
- Negative cutting angle
- Increased core thickness
- Radius tolerance +0.015

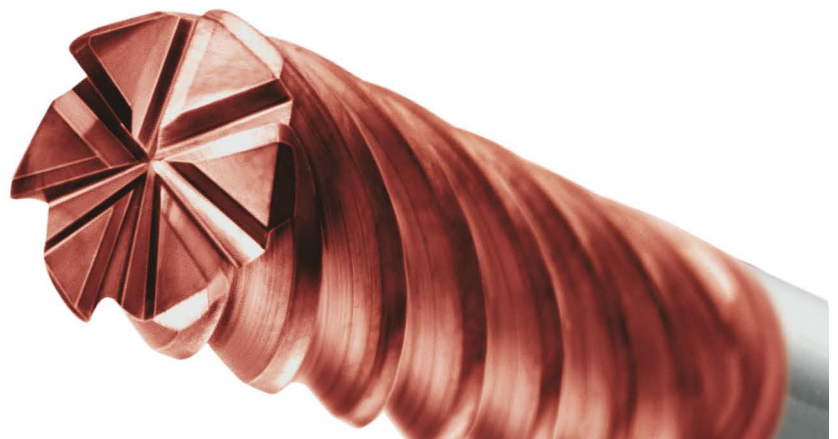

752 555

Kugelfräser VHM+X.Cut 260° Radius für Hinterschnitte
Carbide Radius End Mills+X.Cut 260° Radius for Undercut Milling



- Zur 3D-Bearbeitung im Formenbau
- Umschließungswinkel 260°
- HSC-Bearbeitung mit Hinterschnitten
- Oberfläche X.Cut beschichtet
- 3D copy milling for toolmakers
- Especially HSC milling
- 260° radius for undercut milling
- With X.Cut coating
- Delivery time approx. 5 working days

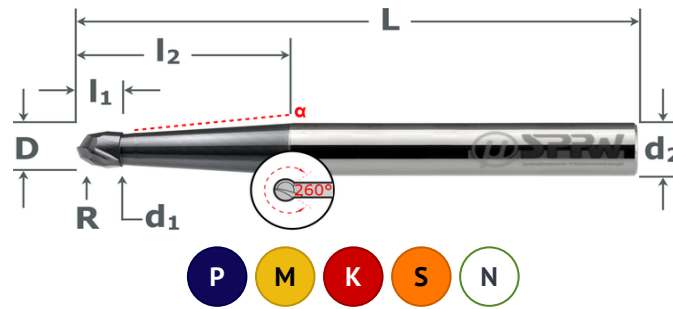

VHM	X Cut
N 30°	z:2
DIN 6535HA	L lang
260° Radius	

ØD h8	Ød2 h6	L	l1	l2	Ød1	a	z	r Radius	Art. No.
2	4	75	1,7	17	1	6°	2	1	7525550200
3	6	100	2,6	17	1,7	8°	2	1,5	7525550310
3	6	150	2,6	30	1,7	4°25'	2	1,5	7525550315
4	6	100	3,5	17	2,4	7°	2	2	7525550410
4	6	150	3,5	30	2,4	3°50'	2	2	7525550415
6	6	100	5,2	30	4	2°10'	2	3	7525550610
6	6	150	5,2	45	4	1°20'	2	3	7525550615
8	8	100	7	35	5	3°10'	2	4	7525550810
8	8	150	7	50	5	1°55'	2	4	7525550815
10	10	100	8,7	40	6,1	3°40'	2	5	7525551010
10	10	150	8,7	60	6,1	2°10'	2	5	7525551015
12	12	100	10,5	50	7,5	3°10'	2	6	7525551210
12	12	150	10,5	75	7,5	1°50'	2	6	7525551215

— INFO —

Lollipop Radiusfräser mit 260° Umschließungswinkel | Lollipop Ball Nose Cutter with 260° Enclosure

- Speziell für Hinterschnitte im Formenbau
- Zum Entgratfräsen geeignet
- Micro im Kapitel H



- Designed for undercut milling in mold making
- Suitable for backward deburring
- Micro in chapter H

J

672 000

Universalfräser VHM+X.Cut 2 Schneiden Carbide End Mills+X.Cut 2 Flutes Stub Series



- Allgemeine Anwendung
- Kurze, stabile Ausführung
- Nut- und Taschenfräsen
- Zentrumschnitt, scharfe Schneidkante
- Oberfläche X.Cut beschichtet
- General purpose milling cutter
- Stub series with high rigidity
- Slotting and pocketing
- Center cutting with sharp edges
- With X.Cut coating

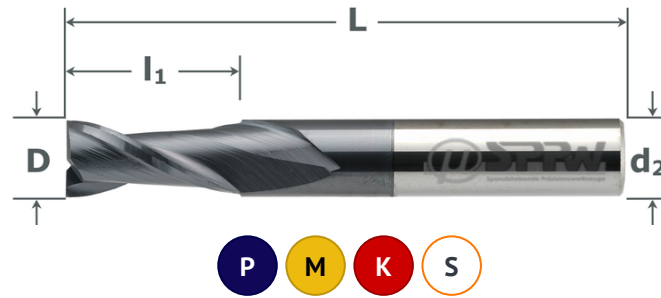

VHM	X Cut
Typ N	z:2
DIN 6535HA	sharp

ØD h9	Ød2 h6	L	l1	z	Schaft	Art. No.	ØD h9	Ød2 h6	L	l1	z	Schaft	Art. No.
2	2	38	8	2	HA	6720000200	10	10	70	22	2	HA	6720001000
3	3	38	12	2	HA	6720000300	12	12	70	22	2	HA	6720001200
4	4	40	12	2	HA	6720000400	14	14	75	25	2	HA	6720001400
5	5	50	14	2	HA	6720000500	15	15	75	25	2	HA	6720001500
6	6	50	16	2	HA	6720000600	16	16	75	25	2	HA	6720001600
7	7	60	20	2	HA	6720000700	18	18	100	32	2	HA	6720001800
8	8	60	20	2	HA	6720000800	20	20	100	32	2	HA	6720002000
9	9	60	20	2	HA	6720000900							

673 000

Universalfräser VHM+X.Cut 3 Schneiden Carbide End Mills+X.Cut 3 Flutes Stub Series



- Allgemeine Anwendung
- Kurze, stabile Ausführung
- Nut- und Taschenfräsen
- Zentrumschnitt, scharfe Schneidkante
- Oberfläche X.Cut beschichtet
- General purpose milling cutter
- Stub series with high rigidity
- Slotting and pocketing
- Center cutting with sharp edges
- With X.Cut coating

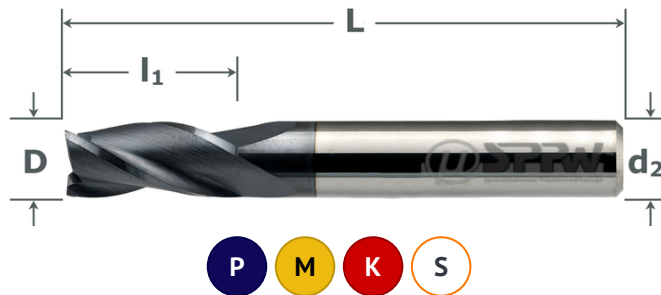

VHM	X Cut
Typ N	z:3
DIN 6535HA	sharp

ØD h9	Ød2 h6	L	l1	z	Schaft	Art. No.	ØD h9	Ød2 h6	L	l1	z	Schaft	Art. No.
2	2	38	8	3	HA	6730000200	8,5	8,5	60	20	3	HA	6730000850
2,5	2,5	38	8	3	HA	6730000250	9	9	60	20	3	HA	6730000900
3	3	38	12	3	HA	6730000300	9,5	9,5	70	22	3	HA	6730000950
3,5	3,5	40	12	3	HA	6730000350	10	10	70	22	3	HA	6730001000
4	4	40	12	3	HA	6730000400	11	11	70	22	3	HA	6730001100
4,5	4,5	50	14	3	HA	6730000450	12	12	70	22	3	HA	6730001200
5	5	50	14	3	HA	6730000500	13	13	75	25	3	HA	6730001300
5,5	5,5	50	16	3	HA	6730000550	14	14	75	25	3	HA	6730001400
6	6	50	16	3	HA	6730000600	15	15	75	25	3	HA	6730001500
6,5	6,5	50	16	3	HA	6730000650	16	16	75	25	3	HA	6730001600
7	7	60	20	3	HA	6730000700	18	18	100	32	3	HA	6730001800
7,5	7,5	60	20	3	HA	6730000750	20	20	100	32	3	HA	6730002000
8	8	60	20	3	HA	6730000800							

662 640

Universalfräser VHM 2 Schneiden Überlang Carbide End Mills 2 Flutes Extra Long Series



- Allgemeine Anwendung
- Zentrumschnitt, scharfe Schneidkante
- Nut- und Taschenfräsen
- Überlange Ausführung, lange Schneide
- Glatter Schaft DIN 6535 HA
- Oberfläche blank

- General purpose milling cutter
- Center cutting, sharp cutting edges
- Slotting and pocketing
- Extra long series with long edges
- Straight shank DIN 6535 HA
- Bright finish

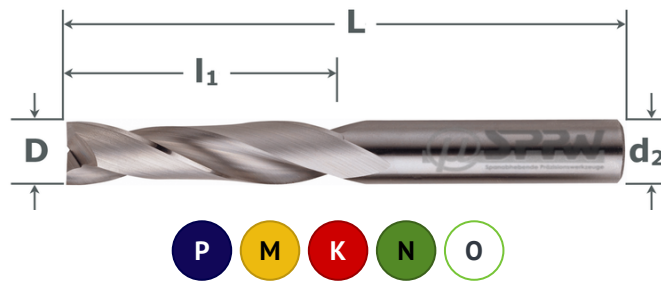

VHM	blank
Typ N	z:2
DIN 6535HA	XL

ØD h9	Ød2 h6	L	l1	z	Art. No.
3	3	70	30	2	6626400300
4	4	75	40	2	6626400400
5	5	80	40	2	6626400500
6	6	80	45	2	6626400600
8	8	100	50	2	6626400800
10	10	100	50	2	6626401000
12	12	150	70	2	6626401200
12	12	100	50	2	6626401201

ØD h9	Ød2 h6	L	l1	z	Art. No.
14	14	150	75	2	6626401400
14	14	100	50	2	6626401401
16	16	150	75	2	6626401600
16	16	100	50	2	6626401601
18	18	150	75	2	6626401800
20	20	150	75	2	6626402000
20	20	100	50	2	6626402001

664 640

Universalfräser VHM 4 Schneiden Überlang Carbide End Mills 4 Flutes Extra Long Series



- Allgemeine Anwendung
- Zentrumschnitt, scharfe Schneidkante
- Umfangs- und Stirnfräsen
- Überlange Ausführung, lange Schneide
- Glatter Schaft DIN 6535 HA
- Oberfläche blank

- General purpose milling cutter
- Center cutting, sharp cutting edges
- Front and peripheral milling
- Extra long series with long edges
- Straight shank DIN 6535 HA
- Bright finish



VHM	blank
Typ N	z:4
DIN 6535HA	XL

ØD h9	Ød2 h6	L	l1	z	Art. No.
3	3	70	30	4	6646400300
4	4	75	40	4	6646400400
5	5	80	40	4	6646400500
6	6	80	45	4	6646400600
8	8	100	50	4	6646400800
10	10	100	50	4	6646401000
12	12	150	70	4	6646401200
12	12	100	50	4	6646401201

ØD h9	Ød2 h6	L	l1	z	Art. No.
14	14	150	75	4	6646401400
14	14	100	50	4	6646401401
16	16	150	75	4	6646401600
16	16	100	50	4	6646401601
18	18	150	75	4	6646401800
20	20	150	75	4	6646402000
20	20	100	50	4	6646402001

J



Spanabhebende Präzisionswerkzeuge

[DE] **HSS-E Fräsen**

[EN] **HSS-E Milling**



passion for precision

[Leidenschaft für Präzision]



Microfräser HSS-E05

HSS-E05 Micro End Mills

Art.No./Page

		HSS E05	blank	micro N	z:2	DIN 1835A	Micro	552 140 Seite K 1
--	--	---------	-------	---------	-----	-----------	-------	-----------------------------

HPC-Fräser Pulvermetall

Powder Metal HPC End Mills

Art.No./Page

		HSS PM	X Cut	DIN 844	Typ HR	z: 4-5	DIN 1835B	574 416 Seite K 2
		HSS PM	X Cut	DIN 844L	Typ HR	z: 4-6	DIN 1835B	574 516 Seite K 2
		HSS PM	X Cut	DIN 844K	Typ NRF	z: 4-5	DIN 1835B	574 476 Seite K 3
		HSS PM	X Cut	DIN 844L	UT 35J38	z: 4-6	DIN 1835B	575 430 Seite K 3
		HSS PM	X Cut	DIN 844	Typ H	z:4	DIN 1835B	574 430 Seite K 4
		HSS PM	X Cut	DIN 844K	Typ H	z: 4-6	DIN 1835B	574 530 Seite K 4

Fräser HSS-E08

HSS-E08 End Mills

Art.No./Page

		HSS E08	blank	DIN 844K	Typ N	z:3	DIN 1835B	1/100	553 442 Seite K 5
		HSS E08	blank	Typ N	z:4	DIN 1835B	XL	554 640 Seite K 5	
		HSS E08	X Cut	DIN 327	Typ N	ToL e8	z:2	DIN 1835B	572 340 Seite K 6
		HSS E08	X Cut	Typ N	ToL e8	z:2	DIN 1835B	572 540 Seite K 6	
		HSS E08	X Cut	DIN 327	Typ N	z:3	DIN 1835B	573 340 Seite K 7	
		HSS E08	X Cut	DIN 844K	Typ N	z:3	DIN 1835B	573 440 Seite K 7	
		HSS E08	X Cut	DIN 844K	Typ N	z: 3-6	DIN 1835B	574 440 Seite K 8	
		HSS E08	X Cut	DIN 844L	Typ N	z: 4-6	DIN 1835B	574 540 Seite K 8	
		HSS E08	X Cut	DIN 844	Typ HR	z: 3-4	DIN 1835B	574 426 Seite K 9	
		HSS E08	X Cut	DIN 844L	Typ HR	z: 3-4	DIN 1835B	574 526 Seite K 9	
		HSS E08	X Cut	DIN 844K	Typ NR	z: 3-5	DIN 1835B	574 446 Seite K 10	

● ● ●		HSS E08	X Cut	DIN 844L	Typ NR	z: 3-5	DIN 1835B	574 546 Seite K 10
-------	---	---------	-------	----------	--------	--------	-----------	-----------------------

Radiusfräser HSS-E08

HSS-E08 Radius End Mills

Art.No./Page

● ● ● ○		HSS E08	blank	DIN 327	Typ N	z:2	DIN 1835B	552 345 Seite K 11
---------	---	---------	-------	---------	-------	-----	-----------	-----------------------

● ● ● ○		HSS E08	blank	L lang	Typ N	z:2	DIN 1835B	552 545 Seite K 11
---------	---	---------	-------	--------	-------	-----	-----------	-----------------------

— INFO —

Fräser mit Bohrung für Aufnahmen mit Passnut

- Walzenstirnfräser
- Scheibenfräser

Milling cutters with bore for arbor with drive keyway

- Shell end mills
- Side milling cutters

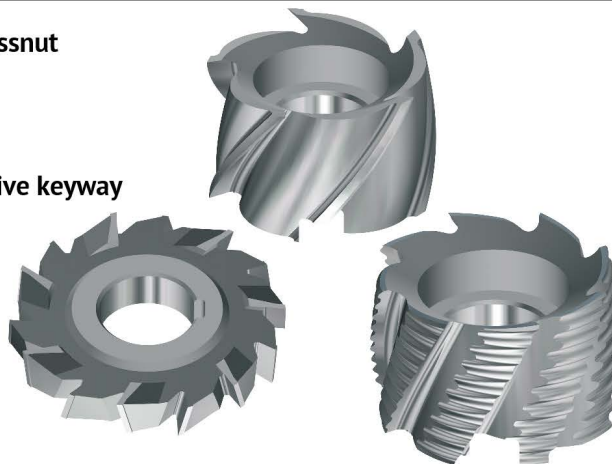

— INFO —

Profilfräser und **Sonderfräser** mit Schaft oder Bohrung in verschiedensten Ausführungen lieferbar. Fragen Sie an!

Profile-cutters and **Special milling tools.**
Please inquire!



552 140

Micro-Bohrnutenfräser HSS-E05 3xØ Kurz 1/10 stg.
HSS-E05 Micro End Mills 3xØ Short Series 1/10 stg.



- Allgemeine Anwendung
- Zentrumschnitt zum Tauchen
- Steigung 1/10 (0,1) mm
- Mit verstärktem Schaft
- Kurze, stabile Ausführung
- Oberfläche blank

- General purpose
- Center cutting for plunging
- Increments of 1/10 (0,1) mm
- With reinforced shank
- Bright finish

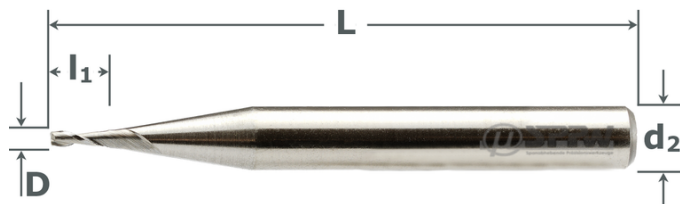

HSS E05	blank
micro N	z:2
DIN 1835A	Micro

ØD	Ød2 h6	L	l1	z	Art. No.
0,3-0,4	3	37	1	2	552140xxxx
0,5-0,6	3	37	1,5	2	552140xxxx
0,7-0,8	4	37	2	2	552140xxxx
0,9	4	37	2,5	2	5521400090
1	4	37	3	2	5521400100
1,1	4	37	3	2	5521400110
1,2-1,6	4	37	4	2	552140xxxx
1,7-1,9	4	37	5	2	552140xxxx
2	4	37	5	2	5521400200
2,1-2,2	4	37	5	2	552140xxxx
2,3-2,7	4	40	7	2	552140xxxx
2,8-2,9	5	44	8	2	552140xxxx
3	5	44	8	2	5521400300
3,1-3,2	5	44	8	2	552140xxxx
3,3-3,7	5	44	10	2	552140xxxx
3,8-3,9	6	51	12	2	552140xxxx
4	6	51	12	2	5521400400
4,1-4,7	6	51	12	2	552140xxxx
4,8-4,9	6	52	14	2	552140xxxx
5	6	52	14	2	5521400500
5,1-5,7	6	52	14	2	552140xxxx

ØD	Ød2 h6	L	l1	z	Art. No.
5,8-5,9	8	60	16	2	552140xxxx
6	8	60	16	2	5521400600
6,1-6,9	8	60	16	2	552140xxxx
7	8	60	16	2	5521400700
7,1-7,7	8	60	16	2	552140xxxx
7,8-7,9	8	61	18	2	552140xxxx
8	8	61	18	2	5521400800
8,1-8,9	10	69	18	2	552140xxxx
9	10	69	18	2	5521400900
9,1-9,7	10	69	18	2	552140xxxx
9,8-9,9	10	69	20	2	552140xxxx
10	10	69	20	2	5521401000
10,1-10,9	12	70	22	2	552140xxxx
11	12	70	22	2	5521401100
11,1-11,9	12	79	26	2	552140xxxx
12	12	79	26	2	5521401200
12,1-12,9	12	83	26	2	552140xxxx
13	12	83	26	2	5521401300
13,1-13,9	12	83	26	2	552140xxxx
14	12	83	26	2	5521401400

K

— INFO —

Microfräser aus VHM ab Ø0,05 im Kapitel H " Micro Fräsen"

- Schneidnängen 0,75xØ - 1,5xØ - 3xØ - 5xØ - 8xØ
- Nutzlängen mit Freistellung bis 30 mm
- Nutfräser, Radiusfräser und Torusfräser



Carbide Micro End Mills from Ø0,05 mm in chapter H "Micro Milling"

- Cutting lengths 0,75xØ - 1,5xØ - 3xØ - 5xØ - 8xØ
- Extended usable lengths up to 30 mm
- Flat nose, ball nose or corner radius



574 416**Hochleistungs-Schruppfräser PM+X.Cut
Powder Metal Roughing End Mills+X.Cut**

- HPC-Schruppen zäharter Werkstoffe
- Zentrumschnitt mit Schutzfase
- Pulvermetall, höchste Spanleistung
- Feine Schrappverzahnung Typ HR
- Schaft DIN 1835 B mit Spannfläche
- Oberfläche X.Cut beschichtet

- Roughing in harder materials
- Center cutting with chamfer
- Powder metal, high chip removal rate
- Fine pitch roughing profile (HR)
- Flatted shank DIN 1835 B
- With X.Cut coating

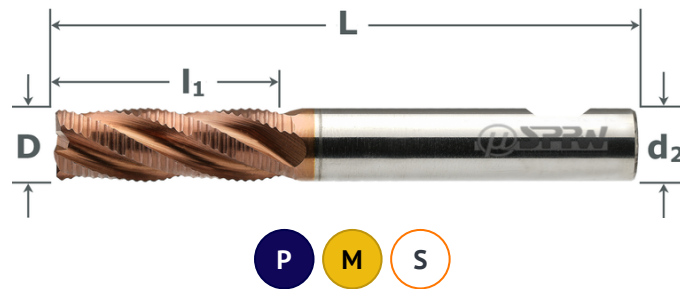

HSS PM	X Cut
DIN 844	Typ HR
z: 4-5	DIN 1835B

ØD k12	d2 h6	L	l1	z	Art. No.	ØD k12	d2 h6	L	l1	z	Art. No.
6	6	57	13	4	5744160600	14	12	83	26	5	5744161400
7	10	66	16	4	5744160700	16	16	92	32	5	5744161600
8	10	69	19	4	5744160800	18	16	92	32	5	5744161800
10	10	72	22	5	5744161000	20	20	104	38	5	5744162000
12	12	83	26	5	5744161200	25	25	121	45	5	5744162500

574 516**Hochleistungs-Schruppfräser PM+X.Cut Lang
Powder Metal Roughing End Mills+X.Cut Long Series**

- HPC-Schruppen zäharter Werkstoffe
- Zentrumschnitt mit Schutzfase
- Pulvermetall, höchste Spanleistung
- Feine Schrappverzahnung Typ HR
- Schaft DIN 1835 B mit Spannfläche
- Oberfläche X.Cut beschichtet

- Roughing in harder materials
- Center cutting with chamfer
- Powder metal, high chip removal rate
- Fine pitch roughing profile (HR)
- Flatted shank DIN 1835 B
- With X.Cut coating

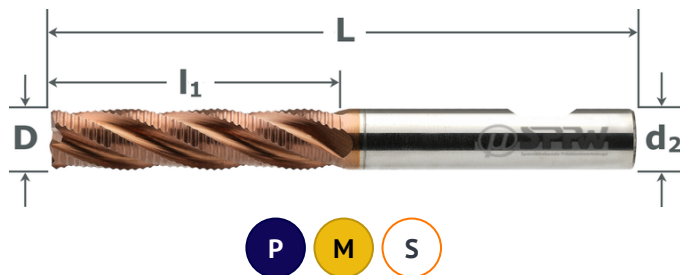

HSS PM	X Cut
DIN 844L	Typ HR
z: 4-6	DIN 1835B

ØD k12	Ød2 h6	L	l1	z	Art. No.	ØD k12	Ød2 h6	L	l1	z	Art. No.
6	6	68	24	4	5745160600	16	16	123	63	4	5745161600
8	10	88	38	4	5745160800	18	16	123	63	4	5745161800
10	10	95	45	4	5745161000	20	20	141	75	4	5745162000
12	12	110	53	4	5745161200	25	25	166	90	5	5745162500
14	12	110	53	4	5745161400	32	32	186	106	6	5745163200

K

574 476

Hochleistungs-Schruppfräser PM+X.Cut
Powder Metal Roughing End Mills+X.Cut



- HPC-Schruppen rostfreier Stähle
- Zentrumschnitt mit Schutzfase
- Pulvermetall, höchste Spanleistung
- Feine Schrappverzahnung Typ NRf 45°
- Schaft DIN 1835 B mit Spannfläche
- Oberfläche X.Cut beschichtet

- Roughing in stainless steels
- Center cutting with chamfer
- Powder metal, high chip removal rates
- Fine pitch roughing profile (NRf 45°)
- Flatted shank DIN 1835 B
- With X.Cut coating

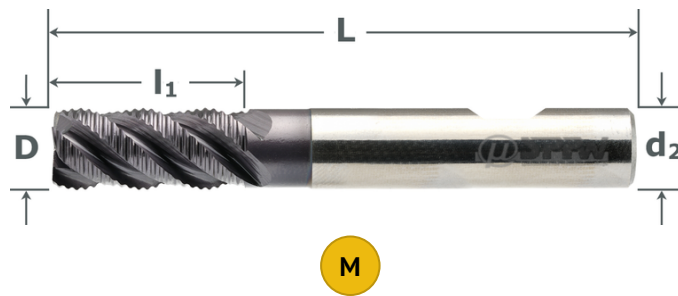

HSS PM	X Cut
DIN 844K	Typ NRf
z: 4-5	DIN 1835B

ØD k12	Ød2 h6	L	l1	z	Art. No.	ØD k12	Ød2 h6	L	l1	z	Art. No.
6	6	57	13	4	5744760600	14	12	83	26	4	5744761400
7	10	66	16	4	5744760700	16	16	92	32	5	5744761600
8	10	69	19	4	5744760800	18	16	92	32	5	5744761800
9	10	69	19	4	5744760900	20	20	104	38	5	5744762000
10	10	72	22	4	5744761000	22	20	104	38	5	5744762200
12	12	83	26	4	5744761200	25	25	121	45	5	5744762500

575 430

Hochleistungs-Schaftfräser PM+X.Cut - Ungleiche Teilung
Powder Metal End Mills+X.Cut - Unequal Helix



- Ungleiche Teilung, 45° Schutzfase
- HP für großes Spanvolumen
- Zentrumschnitt, kurze Version
- Schaft DIN 1835 B mit Spannfläche
- Oberfläche X.Cut beschichtet

- Unequal helix, 45° protection chamfer
- HP applications, high chip volume
- Center cutting, short series
- Flatted shank DIN 1835 B
- With X.Cut coating

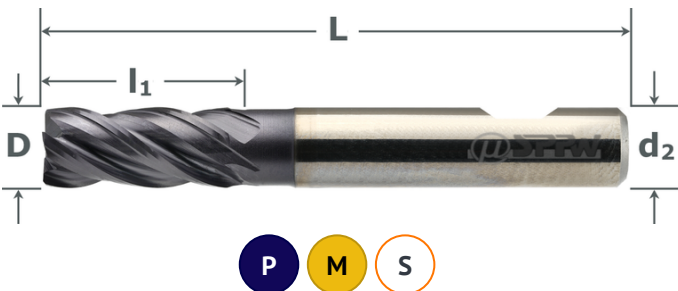

HSS PM	X Cut
DIN 844L	UT 35 38
z: 4-6	DIN 1835B

ØD k10	Ød2 h6	L	l1	z	Art. No.	ØD k10	Ød2 h6	L	l1	z	Art. No.
6	6	57	13	4	5754300600	16	16	92	32	4	5754301600
8	10	69	19	4	5754300800	18	16	92	32	4	5754301800
10	10	72	22	4	5754301000	20	20	104	38	4	5754302000
12	12	83	26	4	5754301200	25	25	121	45	6	5754302500

— INFO —

575 430: PM-Fräser Ungleiche Teilung | Powder Metal Milling Cutters Unequal Helix

- Maximale Materialabtragsrate
- Vibrationsfrei
- Hervorragende Spanabfuhr

- Maximum material removal rate
- Vibration free
- Excellent chip evacuation



574 430

Hochleistungs-Schaftfräser PM+X.Cut
High Performance Powder Metal End Mills+X.Cut



- Zähnharte Werkstoffe
- Zentrumschnitt mit Schutzfase
- Pulvermetall, höchste Spanleistung
- Umfangs- und Stirnfräsen
- Schaft DIN 1835 B mit Spannfläche
- Oberfläche X.Cut beschichtet
- Hard and ductile materials
- Center cutting with chamfer
- Powder metal, high chip removal rates
- Front and peripheral milling
- Flatted shank DIN 1835 B
- With X.Cut coating

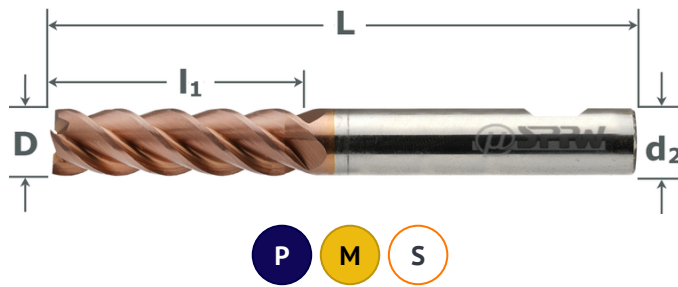

HSS PM	X Cut
DIN 844	Typ H
z:4	DIN 1835B

ØD k10	d2 h6	L	l1	z	Art. No.
2	6	51	7	4	5744300200
3	6	52	8	4	5744300300
4	6	55	11	4	5744300400
5	6	57	13	4	5744300500
6	6	57	13	4	5744300600
8	10	69	19	4	5744300800

ØD k10	d2 h6	L	l1	z	Art. No.
10	10	72	22	4	5744301000
12	12	83	26	4	5744301200
14	12	83	26	4	5744301400
16	16	92	32	4	5744301600
18	16	92	32	4	5744301800
20	20	104	38	4	5744302000

574 530

Hochleistungs-Schaftfräser PM+X.Cut Lang
Powder Metal End Mills+X.Cut Long Series



- Zähnharte Werkstoffe
- Zentrumschnitt mit Schutzfase
- Pulvermetall, höchste Spanleistung
- Umfangs- und Stirnfräsen
- Schaft DIN 1835 B mit Spannfläche
- Oberfläche X.Cut beschichtet
- Hard and ductile materials
- Center cutting with chamfer
- Powder metal, high chip removal rates
- Front and peripheral milling
- Flatted shank DIN 1835 B
- With X.Cut coating

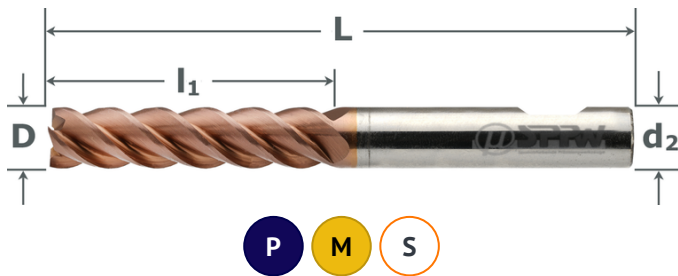

HSS PM	X Cut
DIN 844K	Typ H
z: 4-6	DIN 1835B

ØD k10	Ød2 h6	L	l1	z	Art. No.
6	6	68	24	4	5745300600
8	10	88	38	4	5745300800
10	10	95	45	4	5745301000
12	12	110	53	4	5745301200
14	12	110	53	4	5745301400

ØD k10	Ød2 h6	L	l1	z	Art. No.
16	16	123	63	4	5745301600
18	16	123	63	4	5745301800
20	20	141	75	4	5745302000
25	25	166	90	6	5745302500
32	32	186	106	6	5745303200

K

553 442**Bohrnutenfräser HSS-E08+X.Cut 1/100 steigend**
HSS-E08 End Mills Short Series 1/100 increments

- Zentrumschnitt zum Tauchen
- Steigung 1/100 (0,01) mm
- Schaft DIN 1835 B mit Spannfläche
- Oberfläche blank
- △ SONDER: Lieferzeit 5-8 Arbeitstage, keine Rücknahme. Staffelpreise (1-5)!

- Center cutting for plunging
- Increments of 1/100 (0,01) mm
- Flatted shank according DIN 1835 B
- Bright finish
- △ SPECIAL: Delivery time 5-8 work days. No returns. Scale prices (1-5)!

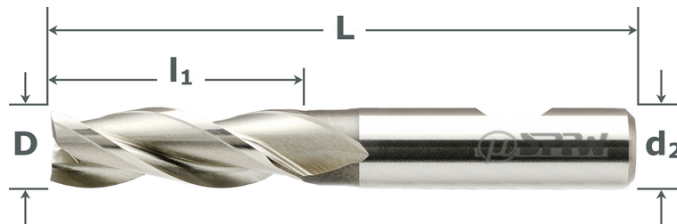

HSS E08	blank
DIN 844K	Typ N
z:3	DIN 1835B
1/100	

ØD	Ød2 h6	L	l1	z	Art. No.
1,50-2,36	6	51	7	3	553442xxxx
2,37-3,00	6	52	8	3	553442xxxx
3,01-3,75	6	54	10	3	553442xxxx
3,76-4,75	6	55	11	3	553442xxxx
4,76-5,00	6	57	13	3	553442xxxx
5,01-6,00	6	57	13	3	553442xxxx
6,01-7,50	10	66	16	3	553442xxxx
7,51-8,00	10	69	19	3	553442xxxx
8,01-9,50	10	69	19	3	553442xxxx
9,51-10,0	10	72	22	3	553442xxxx

ØD	Ød2 h6	L	l1	z	Art. No.
10,01-11,8	12	79	22	3	553442xxxx
11,81-12,0	12	83	26	3	553442xxxx
12,01-14,0	12	83	26	3	553442xxxx
14,01-15,0	12	83	26	3	553442xxxx
15,01-16,0	16	92	32	3	553442xxxx
16,01-17,0	16	92	32	3	553442xxxx
17,01-18,0	16	92	32	3	553442xxxx
18,01-19,0	16	92	32	3	553442xxxx
19,01-20,0	20	104	38	3	553442xxxx

554 640**Schaftfräser HSS-E08 Überlang**
HSS-E08 End Mills Extra Long Series

- Allgemeine Anwendung
- Zentrumschnitt zum Tauchen
- Umfangs- und Stirnfräsen
- Überlange Ausführung
- Schaft DIN 1835 B, Spannfläche
- Oberfläche blank

- General purpose milling cutter
- Center cutting for plunging
- Front and peripheral milling
- Extra long version
- Flatted shank DIN 1835 B
- Bright finish

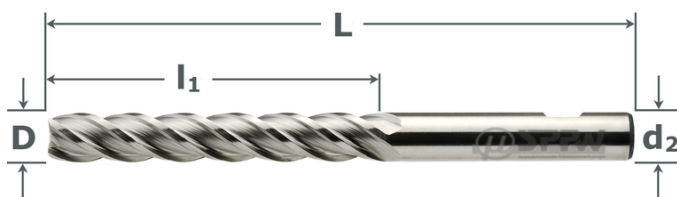

HSS E08	blank
Typ N	z:4
DIN 1835B	XL

ØD k10	Ød2 h6	L	l1	z	Art. No.
6	6	95	50	4	5546400600
8	10	110	60	4	5546400800
10	10	115	65	4	5546401000
12	12	130	75	4	5546401200

ØD k10	Ød2 h6	L	l1	z	Art. No.
14	12	135	80	4	5546401400
16	16	155	95	4	5546401600
18	16	160	100	4	5546401800
20	20	175	110	4	5546402000

572 340**Bohrnutenfräser HSS-E08+X.Cut - Toleranz e8
HSS-E08 End Mills+X.Cut - Tolerance e8**

- Allgemeine Anwendung
- Zentrumschnitt, Toleranz e8
- Nut / Taschenfräsen, Passfedernuten
- Extra kurze, stabile Ausführung
- Schaft DIN 1835 B mit Spannfläche
- Oberfläche X.Cut beschichtet

- General purpose milling cutter
- Center cutting, tolerance e8
- Keyway milling, slotting, pocketing
- Stub series and rigid version
- Flatted shank DIN 1835 B
- With X.Cut coating

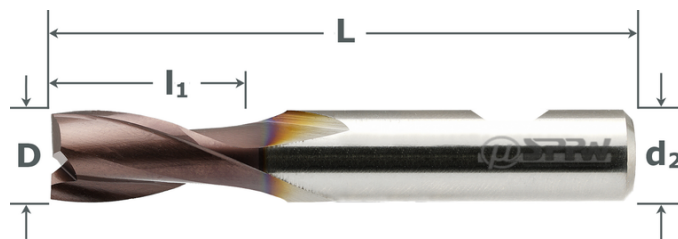

HSS E08	X Cut
DIN 327	Typ N
ToL e8	z:2
DIN 1835B	

572340 - DIN 327 extra-kurz | stub length

ØD e8	Ød2 h6	L	l1	z	Art. No.
2	6	48	4	2	5723400200
2,5	6	49	5	2	5723400250
3	6	49	5	2	5723400300
3,5	6	50	6	2	5723400350
4	6	51	7	2	5723400400
4,5	6	51	7	2	5723400450
5	6	52	8	2	5723400500
5,5	6	52	8	2	5723400550
6	6	52	8	2	5723400600
6,5	10	54	10	2	5723400650
7	10	60	10	2	5723400700
7,5	10	60	10	2	5723400750
8	10	60	11	2	5723400800
8,5	10	61	11	2	5723400850
9	10	61	11	2	5723400900
9,5	10	61	11	2	5723400950
10	10	63	13	2	5723401000
10,5	12	70	13	2	5723401050

ØD e8	Ød2 h6	L	l1	z	Art. No.
11	12	70	13	2	5723401100
11,5	12	70	13	2	5723401150
12	12	73	16	2	5723401200
13	12	73	16	2	5723401300
14	12	73	16	2	5723401400
15	12	73	16	2	5723401500
16	16	79	19	2	5723401600
17	16	79	19	2	5723401700
18	16	79	19	2	5723401800
19	16	79	19	2	5723401900
20	20	88	22	2	5723402000
22	20	88	22	2	5723402200
24	25	102	26	2	5723402400
25	25	102	26	2	5723402500
26	25	102	26	2	5723402600
28	25	102	26	2	5723402800
30	25	102	26	2	5723403000
32	32	112	32	2	5723403200

572540 - lang | long

ØD e8	Ød2 h6	L	l1	z	Art. No.
2	6	54	7	2	5725400200
3	6	56	8	2	5725400300
4	6	63	11	2	5725400400
5	6	68	13	2	5725400500
6	6	68	13	2	5725400600
7	10	74	16	2	5725400700
8	10	88	19	2	5725400800
9	10	88	19	2	5725400900

ØD e8	Ød2 h6	L	l1	z	Art. No.
10	10	95	22	2	5725401000
12	12	110	26	2	5725401200
14	12	110	26	2	5725401400
16	16	123	32	2	5725401600
18	16	123	32	2	5725401800
20	20	141	38	2	5725402000
25	25	166	45	2	5725402500
32	32	186	53	2	5725403200

K

573 340**Bohrnutenfräser HSS-E08+X.Cut Extra Kurz 3 Schneiden**
HSS-E08 End Mills+X.Cut Stub Series 3 Flutes

- Allgemeine Anwendung
- Toleranz e8, Passfedernuten
- 3 Schneiden, 50% mehr Spanleistung
- Schaft DIN 1835 B mit Spannfläche
- Oberfläche X.Cut beschichtet
- General purpose milling cutter
- tolerance e8 for keyway milling
- 3 flutes - 50% high chip removal rate
- Flatted shank DIN 1835 B
- With X.Cut coating

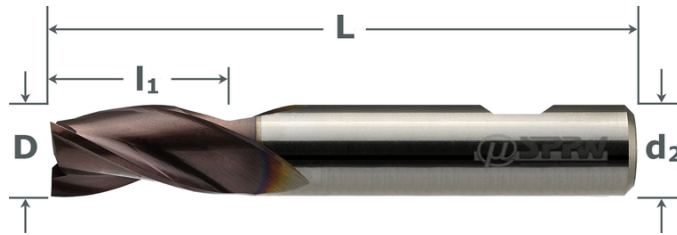

HSS E08	X Cut
DIN 327	Typ N
z:3	DIN 1835B

ØD e8	Ød2 h6	L	l1	z	Art. No.
3	6	49	5	3	5733400300
4	6	51	7	3	5733400400
5	6	52	8	3	5733400500
6	6	52	8	3	5733400600
7	10	60	10	3	5733400700
8	10	61	11	3	5733400800
9	10	61	11	3	5733400900

ØD e8	Ød2 h6	L	l1	z	Art. No.
10	10	63	13	3	5733401000
12	12	73	16	3	5733401200
14	12	73	16	3	5733401400
16	16	79	19	3	5733401600
18	16	79	19	3	5733401800
20	20	88	22	3	5733402000

573 440**Bohrnutenfräser HSS-E08+X.Cut Kurz 3 Schneiden**
HSS-E08 End Mills+X.Cut Short Series 3 Flutes

- Allgemeine Anwendung
- Toleranz e8, Passfedernuten
- 3 Schneiden, 50% mehr Spanleistung
- Schaft DIN 1835 B mit Spannfläche
- Oberfläche X.Cut beschichtet
- General purpose milling cutter
- tolerance e8 for keyway milling
- 3 flutes - 50% high chip removal rate
- Flatted shank DIN 1835 B
- With X.Cut coating

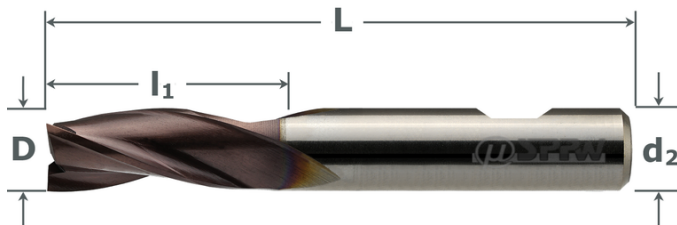

HSS E08	X Cut
DIN 844K	Typ N
z:3	DIN 1835B

ØD e8	Ød2 h6	L	l1	z	Art. No.
3	6	52	8	3	5734400300
4	6	55	11	3	5734400400
5	6	57	13	3	5734400500
6	6	57	13	3	5734400600
7	10	66	16	3	5734400700
8	10	69	19	3	5734400800
9	10	69	19	3	5734400900
10	10	72	22	3	5734401000

ØD e8	Ød2 h6	L	l1	z	Art. No.
11	12	79	22	3	5734401100
12	12	83	26	3	5734401200
13	12	83	26	3	5734401300
14	12	83	26	3	5734401400
15	12	83	26	3	5734401500
16	16	92	32	3	5734401600
18	16	92	32	3	5734401800
20	20	104	38	3	5734402000

K

574 440**Schaftfräser HSS-E08+X.Cut
HSS-E08 End Mills+X.Cut**

- Allgemeine Anwendung
- Zentrumschnitt zum Tauchen
- Umfangs- und Stirnfräsen
- Schaft DIN 1835 B mit Spannfläche
- Oberfläche X.Cut beschichtet

- General purpose milling cutter
- Center cutting for plunging
- Front and peripheral milling
- Flatted shank DIN 1835 B
- With X.Cut coating

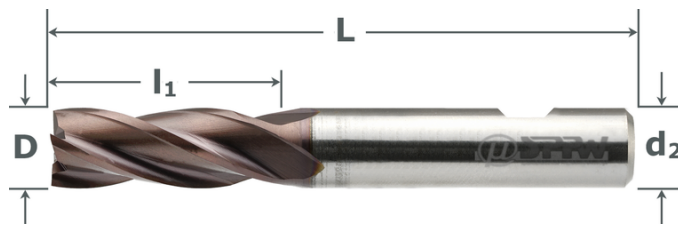

HSS E08	X Cut
DIN 844K	Typ N
z: 3-6	DIN 1835B

ØD k10	Ød2 h6	L	l1	z	Art. No.
2	6	51	7	3	5744400200
2,5	6	52	8	3	5744400250
3	6	52	8	4	5744400300
3,5	6	54	10	4	5744400350
4	6	55	11	4	5744400400
4,5	6	55	11	4	5744400450
5	6	57	13	4	5744400500
5,5	6	57	13	4	5744400550
6	6	57	13	4	5744400600
6,5	10	66	16	4	5744400650
7	10	66	16	4	5744400700
7,5	10	66	16	4	5744400750
8	10	69	19	4	5744400800
8,5	10	69	19	4	5744400850
9	10	69	19	4	5744400900
9,5	10	69	19	4	5744400950
10	10	72	22	4	5744401000

ØD k10	Ød2 h6	L	l1	z	Art. No.
11	12	79	22	4	5744401100
12	12	83	26	4	5744401200
13	12	83	26	4	5744401300
14	12	83	26	4	5744401400
15	12	83	26	4	5744401500
16	16	92	32	4	5744401600
17	16	92	32	4	5744401700
18	16	92	32	4	5744401800
20	20	104	38	4	5744402000
22	20	104	38	5	5744402200
24	25	121	45	5	5744402400
25	25	121	45	5	5744402500
26	25	121	45	5	5744402600
28	25	121	45	5	5744402800
30	25	121	45	5	5744403000
32	32	133	53	5	5744403200

574540 - DIN 844 Lang | long

ØD k10	Ød2 h6	L	l1	z	Art. No.
3	6	56	12	4	5745400300
4	6	63	19	4	5745400400
5	6	68	24	4	5745400500
6	6	68	24	4	5745400600
7	10	74	30	4	5745400700
8	10	88	38	4	5745400800
9	10	88	38	4	5745400900
10	10	95	45	4	5745401000
12	12	110	53	4	5745401200

ØD k10	Ød2 h6	L	l1	z	Art. No.
14	12	110	53	4	5745401400
16	16	123	63	4	5745401600
18	16	123	63	4	5745401800
20	20	141	75	4	5745402000
22	20	141	75	5	5745402200
25	25	166	90	5	5745402500
28	25	166	90	5	5745402800
32	32	186	106	6	5745403200



574 426

Schruppfräser HSS-E08+X.Cut - Typ HR
HSS-E08 Roughing End Mills+X.Cut - Fine Pitch



- Schruppen zäharter Werkstoffe
- Zentrumschnitt zum Tauchen
- Schutzfase an den Schneidecken
- Feine Schruppverzahnung Typ HRf
- Schaft DIN 1835 B mit Spannfläche
- Oberfläche X.Cut beschichtet

- Roughing in harder materials
- Center cutting for plunging
- Protective chamfer on edges
- Fine pitch roughing profile (HRf)
- Flatted shank DIN 1835 B
- With X.Cut coating

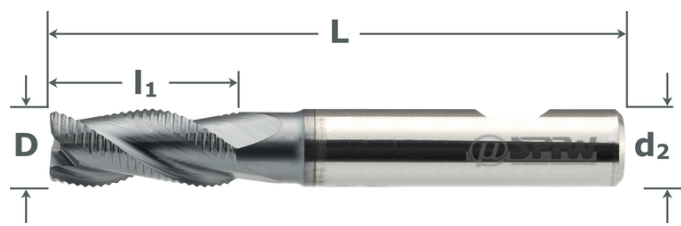

HSS E08	X Cut
DIN 844	Typ HR
z: 3-4	DIN 1835B

ØD k12	Ød2 h6	L	l1	z	Art. No.
10	10	72	22	3	5744261000
11	12	79	22	4	5744261100
12	12	83	26	4	5744261200
14	12	83	26	4	5744261400
16	16	92	32	4	5744261600

ØD k12	Ød2 h6	L	l1	z	Art. No.
18	16	92	32	4	5744261800
20	20	104	38	4	5744262000
25	25	121	45	4	5744262500
32	32	133	53	4	5744263200

574 526

Schruppfräser HSS-E08+X.Cut Lang - Typ HR
HSS-E08 Roughing End Mills+X.Cut Fine Pitch Long Series



- Schruppen zäharter Werkstoffe
- Zentrumschnitt zum Tauchen
- Schutzfase an den Schneidecken
- Extra feine Schruppverzahnung
- Schaft DIN 1835 B mit Spannfläche
- Oberfläche X.Cut beschichtet

- Roughing in harder materials
- Center cutting for plunging
- Protective chamfer on cutting edges
- Extra fine pitch roughing profile (HRf)
- Flatted shank DIN 1835 B
- With X.Cut coating

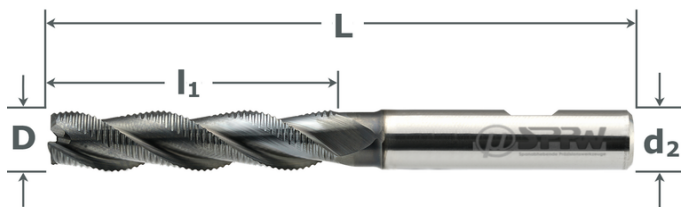

HSS E08	X Cut
DIN 844L	Typ HR
z: 3-4	DIN 1835B

ØD k12	Ød2 h6	L	l1	z	Art. No.
10	10	95	45	3	5745261000
12	12	110	53	4	5745261200
14	12	110	53	4	5745261400
16	16	123	63	4	5745261600

ØD k12	Ød2 h6	L	l1	z	Art. No.
18	16	123	63	4	5745261800
20	20	141	75	4	5745262000
25	25	166	90	4	5745262500
32	32	186	106	4	5745263200

K

574 446

Schruppfräser HSS-E08+X.Cut - Typ NR

HSS-E08 Roughing End Mills+X.Cut - Coarse Pitch



- Allgemeine Anwendung
- Zentrumschnitt zum Tauchen
- Schutzfase an den Schneidecken
- Grobe Schruppverzahnung Typ NR
- Schaft DIN 1835 B mit Spannfläche
- Oberfläche X.Cut beschichtet

- General purpose roughing end mill
- Center cutting for plunging
- Protective chamfer on cutting edges
- Coarse pitch roughing profile (NR)
- Flatted shank DIN 1835 B
- With X.Cut coating

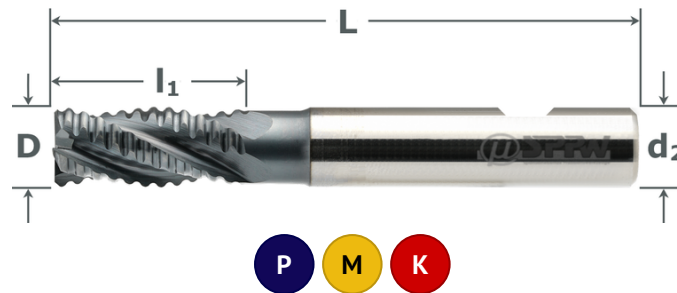

HSS E08	X Cut
DIN 844K	Typ NR
z: 3-5	DIN 1835B

ØD k12	Ød2 h6	L	l1	z	Art. No.	ØD k12	Ød2 h6	L	l1	z	Art. No.
8	10	69	19	3	5744460800	18	16	92	32	4	5744461800
9	10	69	19	3	5744460900	20	20	104	38	4	5744462000
10	10	72	22	4	5744461000	22	20	104	38	4	5744462200
11	12	79	22	4	5744461100	24	25	121	45	4	5744462400
12	12	83	26	4	5744461200	25	25	121	45	4	5744462500
13	12	83	26	4	5744461300	26	25	121	45	4	5744462600
14	12	83	26	4	5744461400	28	25	121	45	5	5744462800
15	12	83	26	4	5744461500	30	25	121	45	5	5744463000
16	16	92	32	4	5744461600	32	32	133	53	5	5744463200

574 546

Schruppfräser HSS-E08+X.Cut Lang - Typ NR

HSS-E08 Roughing End Mills+X.Cut Coarse Pitch Long Series



- Allgemeine Anwendung
- Zentrumschnitt zum Tauchen
- Schutzfase an den Schneidecken
- Grobe Schruppverzahnung Typ NR
- Schaft DIN 1835 B mit Spannfläche
- Oberfläche X.Cut beschichtet

- General purpose roughing end mill
- Center cutting for plunging
- Protective chamfer on cutting edges
- Coarse pitch roughing profile (NR)
- Flatted shank DIN 1835 B
- With X.Cut coating



HSS E08	X Cut
DIN 844L	Typ NR
z: 3-5	DIN 1835B

ØD k12	Ød2 h6	L	l1	z	Art. No.	ØD k12	Ød2 h6	L	l1	z	Art. No.
8	10	88	38	3	5745460800	18	16	123	63	4	5745461800
10	10	95	45	4	5745461000	20	20	141	75	4	5745462000
12	12	110	53	4	5745461200	25	25	166	90	4	5745462500
14	12	110	53	4	5745461400	28	25	166	90	5	5745462800
16	16	123	63	4	5745461600	32	32	186	106	5	5745463200

K

552 345

Radiusfräser HSS-E08
HSS-E08 Radius End Mills



- Allgemeine Anwendung
- Zentrumschnitt, Toleranz h10
- Nut-, Kopier- und Taschenfräsen
- Extra kurze, stabile Ausführung
- Oberfläche blank
- General purpose milling cutter
- Center cutting, tolerance h10
- Slotting, copying and pocketing
- Stub series with high rigidity
- Bright finish

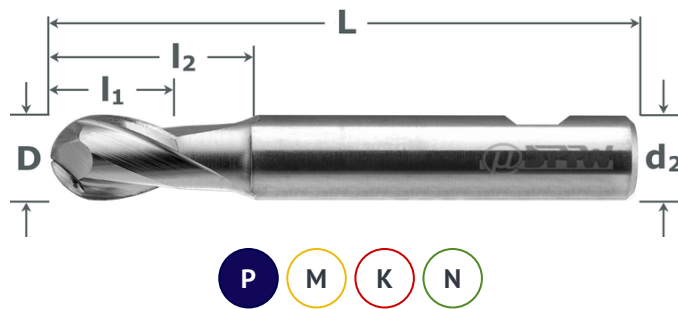

HSS E08	blank
DIN 327	Typ N
z:2	DIN 1835B

ØD h10	Ød2 h6	L	l1	l2	z	Art. No.
3	6	49	5	--	2	5523450300
4	6	51	7	--	2	5523450400
5	6	52	8	--	2	5523450500
6	6	52	8	--	2	5523450600
8	10	61	11	--	2	5523450800
10	10	63	13	23	2	5523451000

ØD h10	Ød2 h6	L	l1	l2	z	Art. No.
12	12	73	16	28	2	5523451200
14	14	73	16	28	2	5523451400
16	16	79	19	31	2	5523451600
18	18	79	19	31	2	5523451800
20	20	88	22	38	2	5523452000

552 545

Radiusfräser HSS-E08 Lang
HSS-E08 Radius End Mills Long Series



- Allgemeine Anwendung
- Zentrumschnitt, Toleranz k10
- Nut-, Kopier- und Taschenfräsen
- Lange Ausführung, kurze Schneide
- Schaft DIN 1835 B mit Spannfläche
- Oberfläche blank
- General purpose milling cutter
- Center cutting, tolerance k10
- Slotting, copying and pocketing
- Long series with high rigidity
- Flatted shank DIN 1835 B
- Bright finish

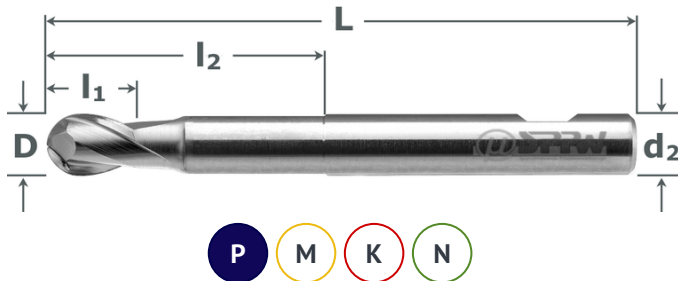

HSS E08	blank
L lang	Typ N
z:2	DIN 1835B

ØD h10	Ød2 h6	L	l1	l2	z	Art. No.
3	3	56	8	--	2	5525450300
4	4	63	11	--	2	5525450400
5	5	68	13	--	2	5525450500
6	6	68	13	--	2	5525450600
8	10	88	19	--	2	5525450800

ØD h10	Ød2 h6	L	l1	l2	z	Art. No.
10	10	95	22	55	2	5525451000
12	12	110	26	65	2	5525451200
14	14	110	26	65	2	5525451400
16	16	120	32	75	2	5525451600
20	20	141	38	91	2	5525452000

— INFO —

Radiusfräser mit X.Cut Beschichtung auf Anfrage
Ball nose end mills with X.Cut coating on request





Spanabhebende Präzisionswerkzeuge

[DE] **Gewindefräsen**
[EN] **Thread Milling**



passion for precision

[Leidenschaft für Präzision]



Micro-/Mini-Innengewindefräser VHM

Micro-Mini-Carbide Thread Whirling Cutter

Art.No./Page

		VHM	X Cut	z:3	DIN 6535HA	Micro	M UN	MS-M Seite L 1
		VHM	X Cut	z:3	DIN 6535HA	Micro	BS 55°	MS-G Seite L 1
		VHM	X Cut	INT	z: 3-6	DIN 6535HA	Mini M UN	NS-MUN Seite L 2
		VHM	X Cut	z:3	DIN 6535HA	Micro	M MF	MM-M Seite L 3
		VHM	X Cut	INT	z: 4-6	DIN 6535HA	Micro M	NM-M Seite L 4

Innengewindefräser VHM - M - UN

Carbide Thread Mills for Internal Threads - M - UN

Art.No./Page

		VHM	X Cut	INT	DIN 6535HA	Thread Burr	M	NB-M Seite L 5
		VHM	X Cut	INT	DIN 6535HA	Thread Burr	M IK cool	NBK-M Seite L 7
		VHM	X Cut	INT	DIN 6535HA	Thread Burr	M IK cool	NBT-M Seite L 8
		VHM	X Cut	INT	z:3	DIN 6535HA	M	NF-M Seite L 8
		VHM	X Cut	z: 3-5	DIN 6535HA	Thread Burr	UN	NB-UN Seite L 9

Außengewinde VHM

Carbide Thread Mills for External Threads

Art.No./Page

		VHM	X Cut	EXT	DIN 6535HA	Thread Burr	M	EB-M Seite L 10
--	--	-----	-------	-----	------------	-------------	---	---------------------------

Innen/Außengewinde VHM

Carbide Thread Mills for Int./External Threads

Art.No./Page

		VHM	X Cut	INT EXT	DIN 6535HA	Thread Burr	G	XB-G Seite L 11
		VHM	X Cut	z: 3-4	DIN 6535HA	Thread Burr	G pipe IK cool	XBT-G Seite L 11
		VHM	X Cut	INT EXT	z: 3-4	DIN 6535HA	Thread Burr PG 80°	XB-PG Seite L 12
		VHM	X Cut	INT EXT	DIN 6535HA	Thread Burr	BSPT Rc	XB-BSPT Seite L 12
		VHM	X Cut	INT EXT	z: 3-5	DIN 6535HA	Thread Burr NPT	XB-NPT Seite L 13
		VHM	X Cut	INT EXT	z: 3-4	DIN 6535HA	Thread Burr NPSF	XB-NPSF Seite L 13

		VHM	X Cut	INT EXT	z: 3-4	DIN 6535HA	Thread Burr	NPTF	XB-NPTF Seite L 14
--	--	-----	-------	---------	--------	------------	-------------	------	------------------------------

Schaftfräser, konisch 1:16 VHM

Carbide Conical End Mills for Pipe Taper

Art.No./Page

		VHM	X Cut	INT EXT	z:4	DIN 6535HA	NPT BSPT	1:16	FC-NPT Seite L 14
--	--	-----	-------	---------	-----	------------	----------	------	-----------------------------

Bohrgewindefräser+IK VHM

Carbide Coolant Feed Drills + Thread Mills Int. Threads

Art.No./Page

		VHM	X Cut	INT	z:2	DIN 6535HA	M	IK cool	NDFK-M Seite L 15
--	--	-----	-------	-----	-----	------------	---	---------	-----------------------------

Modulare Gewindefräser und Schneidplatten

Modular Thread Mills and Inserts

Art.No./Page

		STEEL	BODY	Typ SR	DIN 6535HB	modul R			SR Seite L 16
--	--	-------	------	--------	------------	---------	--	--	-------------------------

		VHM	BODY	Typ SR	DIN 6535HB	modul R			SRC Seite L 16
--	--	-----	------	--------	------------	---------	--	--	--------------------------

		VHM	X Cut	M	UN	G	PG	BSPT	NPT	SR-M WSP Seite L 17
--	--	-----	-------	---	----	---	----	------	-----	-------------------------------

		STEEL	BODY	Typ SRH	DIN 6535HB	modul R				SRH Seite L 19
--	--	-------	------	---------	------------	---------	--	--	--	--------------------------

		STEEL	BODY	SRH Multi	modul R					SRHM Seite L 19
--	--	-------	------	-----------	---------	--	--	--	--	---------------------------

		VHM	X Cut	M	UN	G	NPT	BSPT		SRH-M WSP Seite L 20
--	--	-----	-------	---	----	---	-----	------	--	--------------------------------

MS-M

Micro-Gewindewirbelfräser VHM+X.Cut - Teilprofil 60° Micro-Carbide Thread Whirling Cutter+X.Cut - Partial Profile 60°



- Mit 60° Teilprofil für M/MF Gewinde
- Maximaler Freiheitsgrad
- Geringer Druck für hochfeste Stoffe
- CNC-Steuerung wird benötigt
- Oberfläche X.Cut beschichtet

- Partial profile for M/MF threads
- Maximum freedom for all 60° threads
- Low force for hardmaterials
- CNC control is required
- With X.Cut coating

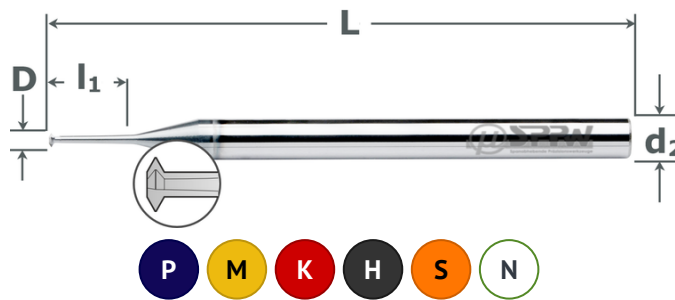

VHM	X Cut
z:3	DIN 6535HA
Micro	M UN

M	ØD*	Ød2 h5	L	l1	Ød1*	C	z	Art. No.
0,8	0,57	3	39	2,4	0,31	0,01	3	SM03057C24M08
0,9	0,64	3	39	2,7	0,35	0,01	3	SM03064C27M09
1	0,71	3	39	3	0,39	0,015	3	SM03071C30M10
1,2	0,91	3	39	3,6	0,57	0,015	3	SM03091C36M12
1,4	1,06	3	39	4,2	0,66	0,02	3	SM03106C42M14
1,6	1,2	3	39	4,8	0,75	0,02	3	SM03120C48M16
2	1,5	3	39	6	0,99	0,02	3	SM03150C60M02
2,5	1,9	3	39	7	1,33	0,025	3	SM03190C70M25
3	2,3	6	66	9	1,62	0,03	3	SM06230C90M03
4	3,1	6	66	12	2,19	0,04	3	SM06310C12M04
5	4	6	66	15	2,98	0,05	3	SM06400C15M05
8	6,5	8	80	22	4,96	0,08	3	SM08650C22M08
10	7,9	8	80	26	6,07	0,09	3	SM08790C26M10

MS-G

Micro-Gewindewirbelfräser VHM+X.Cut Teilprofil 55° Micro-Carbide Thread Whirling Cutter+X.Cut - Partial Profile 55°



- Mit 55° Teilprofil für G/BSP-Gewinde
- Maximaler Freiheitsgrad
- CNC-Steuerung wird benötigt
- Oberfläche X.Cut beschichtet

- 55° partial profile for BS threads
- Maximum freedom for all 55° threads
- CNC control is required
- With X.Cut coating

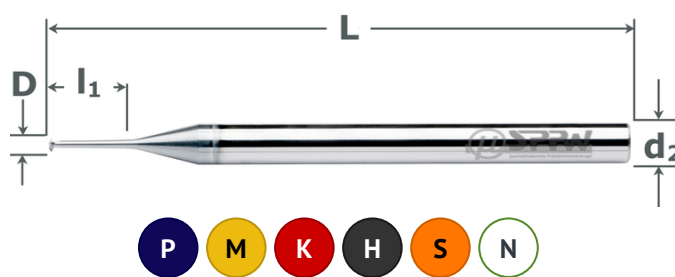

VHM	X Cut
z:3	DIN 6535HA
Micro	BS 55°

G	ØD*	Ød2 h5	L	l1	Ød1*	C	z	Art. No.
1/8	2,3	6	66	9,52	1,4	0,035	3	SM06230C09G18X
5/32	3,1	6	66	11,11	1,75	0,035	3	SM06310C11G532X
3/16	3,65	6	66	19,05	1,8	0,04	3	SM06365C19G316X
1/4	4,85	6	75	22,22	2,7	0,06	3	SM06485C22G14X
5/16	6,25	8	80	25,4	3,8	0,08	3	SM08625C25G516X
3/8	7,5	8	80	25,4	4,8	0,08	3	SM08750C25G38X



- 60° Teilprofil für M/MF, UN-Gewinde
- Maximaler Freiheitsgrad
- Geringer Schnittdruck für feste Stoffe
- CNC-Steuerung wird benötigt
- Oberfläche X6.Cut beschichtet
- Partial profile for M/MF, UN threads
- Maximum freedom for all 60° threads
- Low cutting force for hard materials
- CNC control is required
- With X6.Cut coating

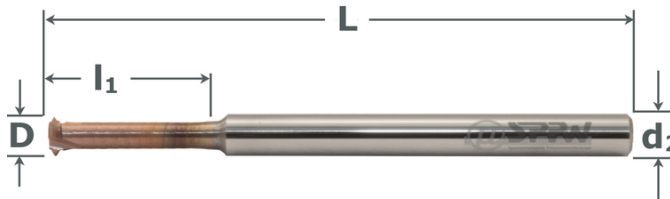

VHM	X Cut
INT	z: 3-6
DIN 6535HA	Mini
M UN	

M ISO	ØD	Ød2	L	l1	z	Art. No.
M0,5	0,37	3	39	1,3	3	NS03003C13P60
M0,6	0,44	3	39	1,5	3	NS03004C15P60
M0,8	0,58	3	39	2	3	NS03005C20P60
M0,8	0,58	3	39	2,7	3	NS03005C27P60
M1	0,7	3	39	1,7	3	NS03007C17P60
M1	0,7	3	39	2,5	3	NS03007C25P60
M1	0,7	3	39	3,2	3	NS03007C32P60
M1	0,72	3	39	2,5	3	NS03007C2025ISO
M1	0,72	3	39	3,5	3	NS03007C3025ISO
M1,2	0,9	3	39	2	3	NS03009C20P60
M1,2	0,9	3	39	2,9	3	NS03009C29P60
M1,2	0,9	3	39	3,9	3	NS03009C39P60
M1,2	0,92	3	39	2,9	3	NS03009C2025ISO
M1,2	0,92	3	39	3,9	3	NS03009C3025ISO
M1,4	1,03	3	39	2,3	3	NS03010C22P60
M1,4	1,03	3	39	3,3	3	NS03010C33P60
M1,4	1,03	3	39	4,4	3	NS03010C44P60
M1,4	1,06	3	39	3,3	3	NS03010C303ISO
M1,4	1,06	3	39	4,4	3	NS03010C403ISO
M1,6	1,2	3	39	3,6	4	NS03012D3035ISO
M1,6	1,2	3	39	5,1	4	NS03012D5035ISO
M1,8	1,4	3	39	4,2	4	NS03014D4035ISO
M1,8	1,4	3	39	5,6	4	NS03014D5035ISO
M2	1,5	4	50	4,4	4	NS04015D4P60
M2	1,5	4	50	6,4	4	NS04015D6P60
M2	1,55	3	39	4,7	4	NS03015D404ISO
M2	1,55	3	39	6,2	4	NS03015D604ISO
M2,2	1,65	4	50	5	4	NS04016D5P60

M ISO	ØD	Ød2	L	l1	z	Art. No.
M2,2	1,65	4	50	7,1	4	NS04016D7P60
M2,5	1,9	4	50	5,5	4	NS04019D5P60
M2,5	1,9	4	50	8	4	NS04019D8P60
M2,5	1,9	4	50	9,2	4	NS04021D9P60
M2,5	2,1	4	50	6,4	4	NS04021D6P60
M3	2,3	4	50	6,5	4	NS04023D6P60
M3	2,3	4	50	9,5	4	NS04023D9P60
M3,5	2,6	4	50	7,6	4	NS04026D7P60
M3,5	2,6	4	50	11,1	4	NS04026D11P60
M4	3	4	50	9,5	4	NS0403D9P60
M4	3,6	4	50	14,3	4	NS04036D14P60
M4,5	3	4	50	13	4	NS0403D13P60
M4,5	3,6	4	50	10	4	NS04036D10P60
M5	4	4	50	11	4	NS0404D11P60
M5	4	4	50	16	4	NS0404D16P60
M6	4,5	6	63	13	4	NS06045D13P60
M6	4,5	6	76	19	4	NS06045D19P60
M8	6	6	63	17,3	5	NS0606E17P60
M8	6	6	76	25,3	5	NS0606E25P60
M10	7,5	8	63	22	5	NS08075E22P60
M10	7,5	8	76	32	5	NS08075E32P60
M12	9	10	76	26	5	NS1009E26P60
M12	9	10	100	38	5	NS1009E38P60
M14	10	10	76	30	5	NS1010E30P60
M14	10	10	100	44	5	NS1010E44P60
M16	12	12	83	34	5	NS1212F34P60
M16	12	12	100	50	6	NS1212F50P60



Teilprofile - 3 Typen

NS-MUN, MS-M mit 60° Flankenwinkel für M und UN Gewinde, MS-G mit 55° Flankenwinkel für Rohrgewinde. Das Teilprofil weist ein halbes Gewindeprofil auf. Es verfügt über 3-6 Schneiden. Für Gewinde im Bereich von M0,5 - M16.

Vorteile:

- Maximaler Freiheitsgrad, es lassen sich alle 60° (55°) Gewinde herstellen
- Sehr geringer Schnittdruck, daher auch für tiefe Gewinde und
- hochfeste Werkstoffe besonders geeignet.

Nachteile:

- Leistungsfähige CNC-Steuerung wird benötigt
- In den Gewindegängen können, anders als beim Vollprofil, Grate zurückbleiben

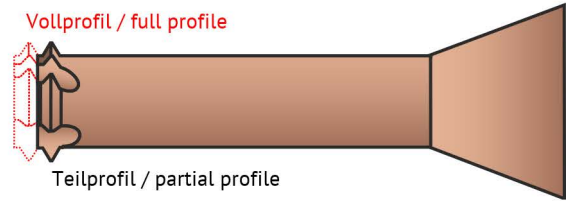

Partial Profiles - 3 Types

NS-MUN, MS-M with 60° flank angle for M and UN threads, MS-G with 55° flank angle for pipe threads. Partial profile only has half a thread profile. It has 3-6 cutting edges. For threads in the range of M0.5 - M16.

Advantages:

- Maximum degree of freedom, all 60° (55°) threads can be produced.
- Very low cutting pressure, therefore also suitable for deep threads and
- high-strength materials particularly suitable

Disadvantages:

- Powerful CNC control is required
- Burrs can remain in the threads, unlike with the full profile

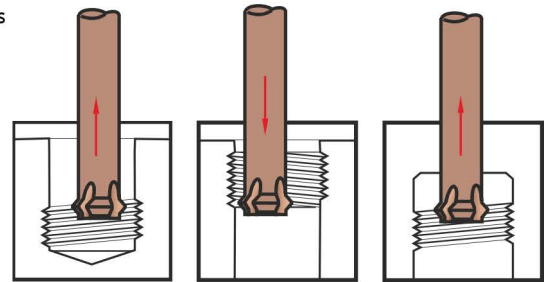

MM-M

Micro-Gewindewirbelfräser VHM+X.Cut - Vollprofil M Micro-Carbide Thread Whirling Cutter+X.Cut - Full Profile M



- Mit 60° Vollprofil für M/MF Gewinde
- Besonders gratfreie Gewinde
- Geringer Druck für hochfeste Stoffe
- CNC-Steuerung wird benötigt
- Oberfläche X.Cut beschichtet
- Partial profile for M/MF threads
- For burr free threads
- Low force for hardmaterials
- CNC control is required
- With X.Cut coating

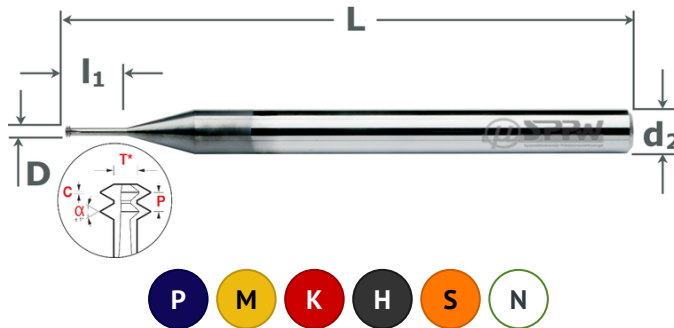

VHM	X Cut
z:3	DIN 6535HA
Micro	M MF

Stg.	M ISO	Ød2 h5	L	l1	ØD	Ød1	z	c	Art. No.
0,2	0,8	3	39	2,4	0,57	0,29	3	0,01	MM03057C24M08
0,225	0,9	3	39	2,7	0,64	0,33	3	0,01	MM03064C27M09
0,25	1	3	39	3	0,71	0,35	3	0,015	MM03071C30M10
0,25	1,2	3	39	3,6	0,91	0,55	3	0,015	MM03091C36M12
0,3	1,4	3	39	4,2	1,06	0,64	3	0,02	MM03106C42M14
0,35	1,6	3	39	4,8	1,2	0,7	3	0,02	MM03120C48M16
0,35	1,8	3	39	5,5	1,4	0,85	3	0,02	MM03140C55M18
0,4	2	3	39	6	1,54	0,9	3	0,02	MM03154C60M20
0,45	2,5	3	39	7	1,95	1,35	3	0,025	MM03195C70M25
0,5	3	6	66	9	2,4	1,7	3	0,03	MM06240C90M30
0,7	4	6	66	12	3,2	2,2	3	0,04	MM06320C12M40
0,8	5	6	66	15	4	2,95	3	0,05	MM06400C15M50
1	6	6	75	18	4,85	3,45	3	0,07	MM06485C18M60



- Typ M-NM mit Vollprofil
- Metrische Gewinde herstellbar
- Geringer Schnittdruck für feste Stoffe
- CNC-Steuerung wird benötigt
- Oberfläche X6.Cut beschichtet
- Type M-NM with full profile
- Metric (M/MF) threads manufacturable
- Low cutting force for hard materials
- CNC control is required
- With X6.Cut coating

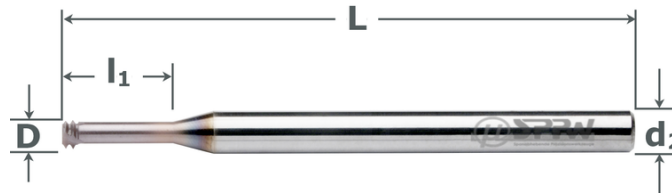

VHM	X Cut
INT	z: 4-6
DIN 6535HA	Micro
M	

Stg.	ØD	Ød2	L	l1	z	nxØ	Art. No.
0,4	1,5	4	50	4,4	4	1,5	NM04015D404ISO
0,4	1,5	4	50	6,4	4	3	NM04015D604ISO
0,45	1,6	4	50	5	4	1,5	NM04016D5045ISO
0,45	1,65	4	50	7,1	4	3	NM04016D7045ISO
0,45	1,9	4	50	5,5	4	1,5	NM04019D5045ISO
0,45	1,9	4	50	8	4	3	NM04019D8045ISO
0,5	2,3	4	50	6,5	5	1,5	NM04023E605ISO
0,5	2,3	4	50	9,5	5	3	NM04023E905ISO
0,6	2,6	4	50	7,6	5	1,5	NM04026E706ISO
0,6	2,6	4	50	11,1	5	3	NM04026E1106ISO
0,7	3	4	50	9	5	1,5	NM0403E907ISO
0,75	3,4	4	50	10	5	2	NM04034E10075ISO
0,75	3,4	4	50	14,3	5	3	NM04034E14075ISO
0,8	3,8	4	50	11	5	1,5	NM04038E1108ISO

Stg.	ØD	Ød2	L	l1	z	nxØ	Art. No.
0,8	3,8	4	50	16	5	3	NM04038E1608ISO
1	4,5	6	63	10	5	1,5	NM06045E1310ISO
1	4,5	6	63	19	5	3	NM06045E1910ISO
1,25	6	6	63	19,3	3	1,5	NM0606E17125ISO
1,25	6	6	76	25,3	5	3	NM0606E25125ISO
1,5	7,5	8	63	22	5	2	NM08075E2215ISO
1,5	7,5	8	76	32	5	3	NM08075E3215ISO
1,75	9	10	76	26	5	2	NM1009E26175ISO
1,75	9	10	100	38	5	3	NM1009E38175ISO
2	10	10	76	30	5	2	NM1010E3020ISO
2	10	10	100	44	5	3	NM1010E4420ISO
2	12	12	83	34	6	2	NM1212F3420ISO
2	12	12	100	50	6	3	NM1212F5020ISO

— INFO —

Vollprofile - 2 Typen

NM-M und MM-M mit 60° Flankenwinkel für metrische Gewinde haben 3-6 Schneiden und sind für Gewinde mit einer Steigung von 0,2 - 2 mm vorgesehen - Bereich von M0,8 - M16.

Vorteile:

- Sehr geringer Schnittdruck, daher auch für tiefe Gewinde und
- hochfeste Werkstoffe besonders geeignet
- Durch Vollprofil besonders gratfreie Übergänge.

Nachteile:

- Geringerer Freiheitsgrad als Teilprofil
- Leistungsfähige CNC-Steuerung wird benötigt

Vollprofil / full profile

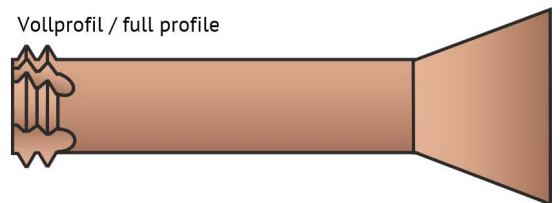

Full Profiles - 2 Types

NM-M and MM-M with 60° flank angle for metric threads, have between 3 and 6 cutting edges. For threads in the range of M0.8 - M16.

Advantages:

- Very low cutting pressure, therefore also suitable for deep threads and
- high-strength materials particularly suitable
- Highest quality of threads

Disadvantages:

- Lesser degree of freedom
- Powerful CNC control is required
- Burrs can remain in the threads, unlike with the full profile

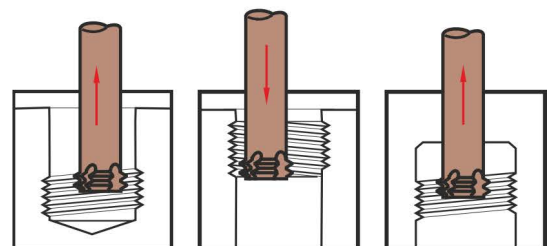



- Universalfräser für Innengewinde
- Entgratstufe für gratfreie Gewinde
- Gewinden, Entgraten in einem Zug
- 15° Spirale für weicheren Schnitt
- Oberfläche X6.Cut beschichtet
- Universal thread mills for metric
- Deburring section for burr free threads
- Threading, deburring in one operation
- 15° helix for softer cutting
- With X6.Cut coating

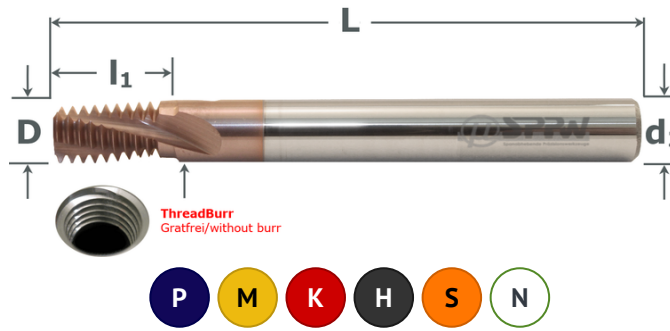

VHM	X Cut
INT	DIN 6535HA
Thread Burr	M

Stg.	ØD	Ød2	L	l1	z	nxØ	Art. No.
0,4	1,5	4	50	3,4	3	1,5	NB04015C304ISO
0,4	1,5	4	50	4,6	3	2	NB04015C404ISO
0,45	1,6	4	50	3,82	3	1,5	NB04016C3045ISO
0,45	1,6	4	50	5,17	3	2	NB04016C5045ISO
0,45	1,9	4	50	4,27	3	1,5	NB04019C4045ISO
0,45	1,9	4	50	5,62	3	2	NB04019C5045ISO
0,5	2,3	4	50	5,25	3	1,5	NB04023C505ISO
0,5	2,3	4	50	6,75	3	2	NB04023C605ISO
0,5	2,3	4	50	8,25	3	2,5	NB04023C805ISO
0,5	2,3	6	63	5,25	3	1,5	NB06023C505ISO
0,5	2,3	6	63	6,75	3	2	NB06023C605ISO
0,5	2,3	6	63	8,25	3	2,5	NB06023C805ISO
0,5	3,8	4	50	10,75	3	2	NB04038C1005ISO
0,5	3,8	6	63	10,75	3	2	NB06038C1005ISO
0,6	2,6	4	50	6,3	3	1,5	NB04026C606ISO
0,6	2,6	4	50	8,1	3	2	NB04026C806ISO
0,7	3	4	50	7,35	3	1,5	NB0403C707ISO
0,7	3	4	50	8,75	3	2	NB0403C807ISO
0,7	3	6	63	7,35	3	1,5	NB0603C707ISO
0,7	3	6	63	8,75	3	2	NB0603C807ISO
0,7	3	4	50	10,85	3	2,5	NB0403C1007ISO
0,7	3	6	63	10,85	3	2,5	NB0603C1007ISO
0,75	3,4	4	50	7,87	3	1,5	NB04034C7075ISO
0,75	3,4	4	50	10,12	3	2	NB04034C10075ISO
0,75	4,5	6	63	10,87	3	1,5	NB06045C10075ISO
0,75	4,5	6	63	16,87	3	2,5	NB06045C16075ISO
0,8	3,8	4	50	8,4	3	1,5	NB04038C808ISO
0,8	3,8	6	63	8,4	3	1,5	NB06038C808ISO
0,8	3,8	4	50	10,8	3	2	NB04038C1008ISO
0,8	3,8	4	50	13,2	3	2,5	NB04038C1308ISO
0,8	3,8	6	63	10,8	3	2	NB06038C1008ISO
0,8	3,8	6	63	13,2	3	2,5	NB06038C1308ISO
1	4,5	6	63	10,5	3	1,5	NB06045C1010ISO
1	4,5	6	63	13,5	3	2	NB06045C1310ISO
1	4,5	6	63	16,5	3	2,5	NB06045C1610ISO
1	4,5	6	63	19,5	3	3	NB06045C1910ISO
1	6	6	63	10,5	3	1	NB0606C1010ISO
1	6	6	63	13,5	3	1,5	NB0606C1310ISO

Stg.	ØD	Ød2	L	l1	z	nxØ	Art. No.
1	8	8	63	10,5	4	1	NB0808D1010ISO
1	8	8	63	13,5	4	1	NB0808D1310ISO
1	8	8	63	17,5	4	1,5	NB0808D1710ISO
1	10	10	76	14,5	5	1	NB1010E1410ISO
1	10	10	76	19,5	5	1,5	NB1010E1910ISO
1	12	12	83	15,5	6	1	NB1212F1510ISO
1	12	12	83	21,5	6	1,5	NB1212F2110ISO
1,25	6	6	63	14,37	3	1,5	NB0606C14125ISO
1,25	6	6	63	18,12	3	2	NB0606C18125ISO
1,25	6	6	63	21,87	3	2,5	NB0606C21125ISO
1,25	6	6	76	25,62	3	3	NB0606C25125ISO
1,5	7,5	8	63	17,25	3	1,5	NB08075C1715ISO
1,5	7,5	8	76	21,75	3	2	NB08075C2115ISO
1,5	7,5	8	76	27,75	3	2,5	NB08075C2715ISO
1,5	7,5	8	76	32,25	3	3	NB08075C3215ISO
1,5	10	10	76	17,25	4	1	NB1010D1715ISO
1,5	10	10	76	23,25	4	1,5	NB1010D2315ISO
1,5	12	12	83	15,75	5	1	NB1212E1515ISO
1,5	12	12	83	21,75	5	1	NB1212E2115ISO
1,5	12	12	83	29,25	5	1,5	NB1212E2915ISO
1,5	16	16	89	18,75	6	1	NB1616F1815ISO
1,5	16	16	89	26,25	6	1	NB1616F2615ISO
1,5	16	16	100	35,25	6	1,5	NB1616F3515ISO
1,75	8	8	76	20,12	3	1,5	NB0808C20175ISO
1,75	8	8	76	27,12	3	2	NB0808C27175ISO
1,75	9	10	76	20,12	3	1,5	NB1009C20175ISO
1,75	9	10	76	27,12	3	2	NB1009C27175ISO
1,75	9	10	100	32,37	3	2,5	NB1009C32175ISO
1,75	9	10	100	37,62	3	3	NB1009C37175ISO
2	10	10	76	23	3	1,5	NB1010C2320ISO
2	10	10	100	31	3	2	NB1010C3120ISO
2	10	10	100	37	3	2,5	NB1010C3720ISO
2	12	12	83	27	4	1,5	NB1212D2720ISO
2	12	12	89	29	5	1,5	NB1616E2920ISO
2	12	12	100	35	4	2	NB1212D3520ISO
2	12	12	100	43	4	2,5	NB1212D4320ISO
2	12	12	100	51	3	3	NB1212C5120ISO
2	16	16	100	39	5	1,5	NB1616E3920ISO



- Universalfräser für Innengewinde
- Entgratstufe für gratfreie Gewinde
- Gewinden, Entgraten in einem Zug
- 15° Spirale für weicheren Schnitt
- Oberfläche X6.Cut beschichtet
- Universal thread mills for metric
- Deburring section for burr free threads
- Threading, deburring in one operation
- 15° helix for softer cutting
- With X6.Cut coating

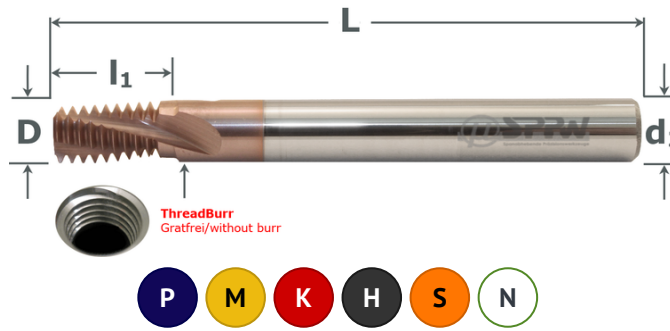

VHM	X Cut
INT	DIN 6535HA
Thread Burr	M

Stg.	ØD	Ød2	L	l1	z	nxØ	Art. No.
2	20	20	100	43	6	1,5	NB2020F4320ISO
2	20	20	120	57	6	2	NB2020F5720ISO
2,5	12	12	100	31,25	3	1,5	NB1212C3125ISO
2,5	12	12	100	38,75	3	2	NB1212C3825ISO
2,5	12	12	100	48,75	3	2,5	NB1212C4825ISO
2,5	14	14	89	33,75	4	1,5	NB1414D3325ISO
2,5	14	14	100	43,75	4	2	NB1414D4325ISO
2,5	15	16	120	53,75	4	2,5	NB1615D5325ISO
2,5	15	16	120	63,75	3	3	NB1615C6325ISO

Stg.	ØD	Ød2	L	l1	z	nxØ	Art. No.
3	16	16	100	40,5	3	1,5	NB1616C4030ISO
3	16	16	120	52,5	3	2	NB1616C5230ISO
3	18	18	130	64,5	3	2,5	NB1818C6430ISO
3	20	20	120	46,5	4	1,5	NB2020D4630ISO
3	20	20	150	61,5	4	2	NB2020D6130ISO
3,5	20	20	120	50,75	3	1,5	NB2020C5035ISO
3,5	20	20	150	64,75	3	2	NB2020C6435ISO
3,5	20	20	150	78,75	3	2,5	NB2020C7835ISO
4	20	20	150	58	3	1,5	NB2020C5840ISO

— INFO —

ThreadBurr - Gewindefräser mit spezieller Entgratstufe
ThreadBurr - Thread Milling Cutter with special deburring geometry

Konventionell
mit Grat/with burr



ThreadBurr
gratfrei/without burr



ThreadBurr
mit spezieller Entgratstufe
ThreadBurr
special deburring section

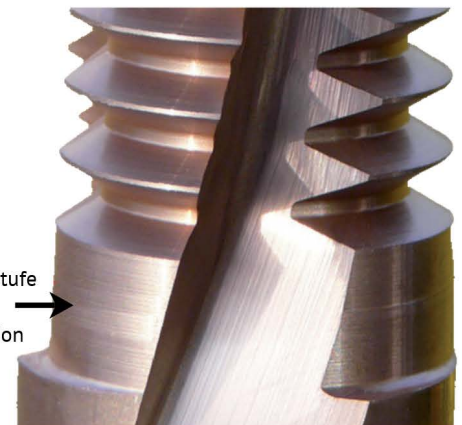



- Typ NBK gerader, axialer Kühlkanal
- Für metrische ISO-Innengewinde
- Entgratstufe für gratfreie Gewinde
- Gewinden, Entgraten in einem Zug
- Oberfläche X6.Cut beschichtet
- Type NBK straight axial coolant bore
- For internal metrical ISO-threads
- Simultaneous threading/deburring
- With X6.Cut coating

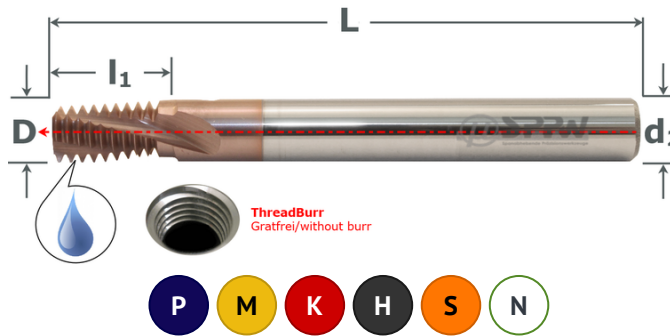

VHM	X Cut
INT	DIN 6535HA
Thread Burr	M
IK cool	

Stg.	ØD	Ød2	L	l1	z	nxØ	Art. No.
0,8	3,8	4	50	8,4	3	1,5	NBK04038C808ISO
0,8	3,8	4	50	10,8	3	2	NBK04038C1008ISO
0,8	3,8	4	50	13,2	3	2,5	NBK04038C1308ISO
1	4,5	6	63	10,5	3	1,5	NBK06045C1010ISO
1	4,5	6	63	13,5	3	2	NBK06045C1310ISO
1	4,5	6	63	16,5	3	2,5	NBK06045C1610ISO
1	8	8	76	17,5	3	1,5	NBK0808D1710ISO
1,25	6	6	63	14,37	3	1,5	NBK0606C14125ISO
1,25	6	6	63	18,12	3	2	NBK0606C18125ISO
1,25	6	6	63	21,87	3	2,5	NBK0606C21125ISO
1,5	7,5	8	76	17,25	3	1,5	NBK08075C1715ISO
1,5	7,5	8	76	21,75	3	2	NBK08075C2115ISO
1,5	7,5	8	76	27,75	3	2,5	NBK08075C2715ISO
1,5	7,5	8	76	32,25	3	3	NBK08075C3215ISO
1,5	16	16	120	35,25	6	1,5	NBK1616F3515ISO
1,75	8	8	76	20,12	3	1,5	NBK0808C20175ISO
1,75	8	8	76	27,12	3	2	NBK0808C27175ISO
1,75	9	10	100	20,12	3	1,5	NBK1009C20175ISO

Stg.	ØD	Ød2	L	l1	z	nxØ	Art. No.
1,75	9	10	100	27,12	3	2	NBK1009C27175ISO
1,75	9	10	100	32,37	3	2,5	NBK1009C32175ISO
1,75	9	10	100	37,62	3	3	NBK1009C37175ISO
2	10	10	100	23	3	1,5	NBK1010C2320ISO
2	10	10	100	31	3	2	NBK1010C3120ISO
2	12	12	100	27	4	1,5	NBK1212D2720ISO
2	12	12	100	35	4	2	NBK1212D3520ISO
2	12	12	100	43	4	2,5	NBK1212D4320ISO
2	12	12	100	51	3	3	NBK1212C5120ISO
2	16	16	120	39	5	1,5	NBK1616E3920ISO
2,5	14	14	100	33,75	4	1,5	NBK1414D3325ISO
2,5	14	14	100	43,75	4	2	NBK1414D4325ISO
2,5	15	16	120	53,75	4	2,5	NBK1615D5325ISO
3	16	16	120	40,5	3	1,5	NBK1616C4030ISO
3	16	16	120	52,5	3	2	NBK1616C5230ISO
3,5	20	20	150	50,75	3	1,5	NBK2020C5035ISO
3,5	20	20	150	64,75	3	2	NBK2020C6435ISO

— INFO —

ThreadBurr - mit Innenkühlung
ThreadBurr - Thread Milling Cutter with Internal Cooling

NBK-M: Axial
 Zentraler Kühlmittelkanal
 Central cooling duct

NBT-M + XBT-G: Radial
 Kühlmittelaustritt in der Spannutt
 Coolant exits in the flutes



NBT-M

Hochleistungs-Innengewindefräser VHM+X.Cut - M mit IK Carbide HP Coolant Feed Thread Mills+X.Cut



- Typ NBT zentraler Kühlkanal
- Kühlmittelaustritt in der Spannweite
- Für metrische ISO-Innengewinde
- Gewinden, Entgraten in einem Zug
- Oberfläche X6.Cut beschichtet
- Type NBT central coolant bore
- Radial cooling through flutes
- For internal metric ISO-threads
- Threading, deburring in 1 operation
- With X6.Cut coating

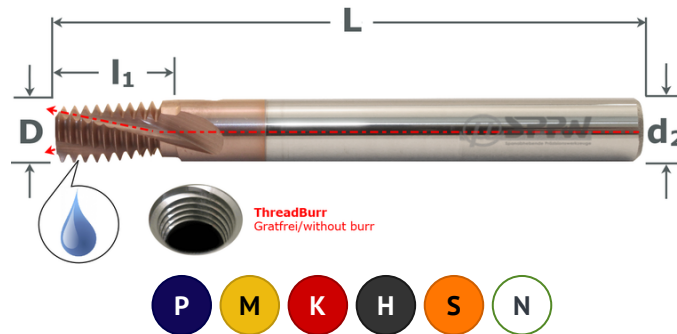

VHM	X Cut
INT	DIN 6535HA
Thread Burr	M
IK cool	

Stg.	ØD	Ød2	L	l1	z	nxØ	Art. No.
1	8	8	76	17,5	4	1,5	NBT0808D1710ISO
1,25	6	6	76	18,12	3	2	NBT0606C18125ISO
1,5	7,5	8	76	21,75	3	2	NBT08075C2115ISO
1,5	12	12	100	29,25	5	1,5	NBT1212E2915ISO
1,75	8	8	76	27,12	3	2	NBT0808C27175ISO

Stg.	ØD	Ød2	L	l1	z	nxØ	Art. No.
1,75	9	10	100	27,12	3	2	NBT1009C27175ISO
2	10	10	100	31	3	2	NBT1010C3120ISO
2	12	12	100	35	4	2	NBT1212D3520ISO
2	16	16	100	39	5	1,5	NBT1616E3920ISO

NF-M

Innengewindefräser VHM+X.Cut mit Fase Carbide Thread Mills+X.Cut with Chamfer



- Für metrische ISO-Innengewinde
- Gewinde und Fasen in einem Zug
- Herstellen von 45° Fasen
- Oberfläche X6.Cut beschichtet
- For internal metric ISO-threads
- Simultaneous threading, chamfering
- Production of 45° chamfers
- With X6.Cut coating

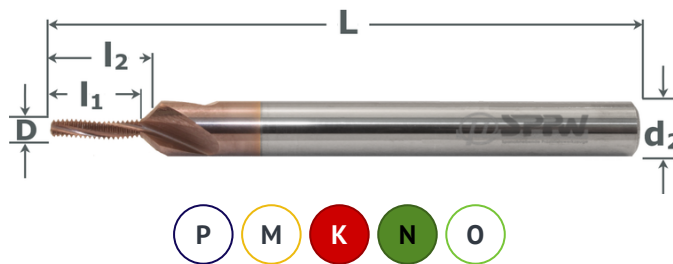

VHM	X Cut
INT	z:3
DIN 6535HA	M

Stg.	ØD	L	l1	l2	Ød2	nxØ	Art. No.
0,5	2,3	63	5,25	5,85	6	1,5	NF06023C505ISO
0,5	2,3	63	6,75	7,35	6	2	NF06023C605ISO
0,5	2,3	63	8,25	8,85	6	2,5	NF06023C805ISO
0,5	2,3	63	9,75	10,35	6	3	NF06023C905ISO
0,7	3	63	7,35	8,2	6	1,5	NF0603C707ISO
0,7	3	63	8,75	9,6	6	2	NF0603C807ISO
0,7	3	63	10,85	11,7	6	2,5	NF0603C1007ISO
0,7	3	63	12,95	13,8	6	3	NF0603C1207ISO
0,8	3,8	63	8,4	9,4	6	1,5	NF06038C808ISO
0,8	3,8	63	10,8	11,8	6	2	NF06038C1008ISO
0,8	3,8	63	13,2	14,2	6	2,5	NF06038C1308ISO
0,8	3,8	63	16,4	17,4	6	3	NF06038C1608ISO

Stg.	ØD	L	l1	l2	Ød2	nxØ	Art. No.
1	4,5	63	10,5	11,75	8	1,5	NF08045C1010ISO
1	4,5	63	13,5	14,75	8	2	NF08045C1310ISO
1	4,5	63	16,5	17,75	8	2,5	NF08045C1610ISO
1,25	6	76	14,37	16	10	1,5	NF1006C14125ISO
1,25	6	76	18,12	19,75	10	2	NF1006C18125ISO
1,25	6	76	21,87	23,5	10	2,5	NF1006C21125ISO
1,5	7,5	83	17,25	19,25	12	1,5	NF12075C1715ISO
1,5	7,5	83	21,75	23,75	12	2	NF12075C2115ISO
1,5	7,5	83	27,75	29,75	12	2,5	NF12075C2715ISO
1,75	9	89	20,12	22,5	14	1,5	NF1409C20175ISO
1,75	9	89	27,12	29,5	14	2	NF1409C27175ISO
1,75	9	89	32,37	34,75	14	2,5	NF1409C32175ISO





- Für UNC/UNF Innengewinde
- UNC: Unified National Coarse
- UNF: Unified National Fine
- Gewinden, Entgraten in einem Zug
- Oberfläche X6.Cut beschichtet
- For internal UNC/UNF threads
- simultaneous threading/deburring
- With X6.Cut coating

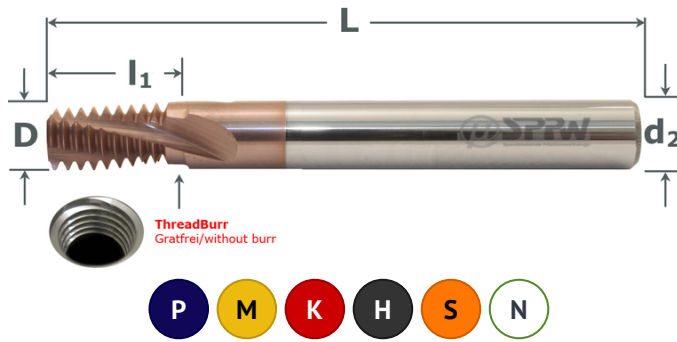

VHM	X Cut
z: 3-5	DIN 6535HA
Thread Burr	UN



Stg. TPI	ØD	Ød2	L	l1	z	nxØ	Art. No.
64	1,7	4	50	3,77	3	1,5	NB04017C364UN
64	1,7	4	50	4,96	3	2	NB04017C564UN
56	1,6	4	50	3,86	3	1,5	NB04016C356UN
56	1,6	4	50	5,22	3	2	NB04016C556UN
56	1,9	4	50	4,31	3	1,5	NB04019C456UN
56	1,9	4	50	5,67	3	2	NB04019C556UN
48	1,9	4	50	4,5	3	1,5	NB04019C448UN
48	1,9	4	50	5,56	3	2	NB04019C548UN
48	2,1	4	50	4,5	3	1,5	NB04021C548UN
48	2,1	4	50	6,61	3	2	NB04021C648UN
44	2,4	4	50	5,48	3	1,5	NB04024C544UN
44	2,4	4	50	7,22	3	2	NB04024C744UN
40	2,1	4	50	5,4	3	1,5	NB04021C540UN
40	2,1	4	50	6,67	3	2	NB04021C640UN
40	2,3	4	50	5,4	3	1,5	NB04023C540UN
40	2,3	4	50	7,3	3	2	NB04023C740UN
40	2,3	4	50	8,57	3	2,5	NB04023C840UN
40	2,6	4	50	6,03	3	1,5	NB04026C640UN
40	2,6	4	50	7,94	3	2	NB04026C840UN
36	3,1	4	50	7,41	3	1,5	NB04031C736UN
36	3,1	4	50	9,53	3	2	NB04031C936UN
32	2,5	4	50	6,75	3	1,5	NB04025C632UN
32	2,5	4	50	8,33	3	2	NB04025C832UN
32	2,5	4	50	9,92	3	2,5	NB04025C1032UN
32	3	4	50	7,54	3	1,5	NB0403C732UN
32	3	4	50	9,13	3	2	NB0403C932UN
32	3	4	50	11,51	3	2,5	NB0403C1132UN
32	3,6	4	50	8,33	3	1,5	NB04036C832UN
32	3,6	4	50	10,72	3	2	NB04036C1032UN
32	6	6	63	13,1	4	1,5	NB0606D1332UN
28	4	4	50	9,52	3	1,5	NB0404C928UN
28	4	4	50	12,25	3	2	NB0404C1228UN
28	5	6	63	10,43	3	1,5	NB0605C1028UN
28	5	6	63	14,06	3	2	NB0605C1428UN
28	8	8	63	17,69	4	1,5	NB0808D1728UN
24	3,6	4	50	9	3	1,5	NB04036C924UN
24	3,6	4	50	11,11	3	2	NB04036C1124UN

Stg. TPI	ØD	Ød2	L	l1	z	nxØ	Art. No.
24	3,6	4	50	13,23	3	2,5	NB04036C1324UN
24	4	4	50	10,05	3	1,5	NB0404C1024UN
24	4	4	50	12,17	3	2	NB0404C1224UN
24	4	4	50	15,35	3	2,5	NB0404C1524UN
24	6	6	63	13,23	3	1,5	NB0606C1324UN
24	6	6	63	17,46	3	2	NB0606C1724UN
24	7,6	8	63	15,35	3	1,5	NB08076C1524UN
24	7,6	8	76	20,64	3	2	NB08076C2024UN
20	4,5	6	63	10,8	3	1,5	NB06045C1020UN
20	4,5	6	63	14,6	3	2	NB06045C1420UN
20	4,5	6	63	17,15	3	2,5	NB06045C1720UN
20	8	8	63	18,41	3	1,5	NB0808C1820UN
20	8	8	76	23,5	3	2	NB0808C2320UN
20	10	10	76	20,96	4	1,5	NB1010D2120UN
20	10	10	76	27,31	4	2	NB1010D2720UN
20	12	12	83	28,57	5	1,5	NB1212E2820UN
18	5,8	6	63	13,41	3	1,5	NB06058C1318UN
18	5,8	6	63	17,64	3	2	NB06058C1718UN
18	5,8	6	63	21,87	3	2,5	NB06058C2118UN
18	10	10	76	23,28	4	1,5	NB1010D2318UN
18	10	10	100	30,34	4	2	NB1010D3018UN
18	12	12	83	26,11	4	1,5	NB1212D2618UN
18	12	12	100	33,16	4	2	NB1212D3318UN
16	6	6	63	16,67	3	1,5	NB0606C1616UN
16	6	6	63	21,43	3	2	NB0606C2116UN
16	7	8	76	26,19	3	2,5	NB0807C2616UN
16	12	12	100	30,96	4	1,5	NB1212D3116UN
16	12	12	100	40,48	4	2	NB1212D4016UN
16	16	16	100	35,72	5	1,5	NB1616E3516UN
14	8	8	63	19,05	3	1,5	NB0808C1914UN
14	8	8	76	24,49	3	2	NB0808C2414UN
14	8	8	76	29,94	3	2,5	NB0808C3014UN
14	16	16	100	35,38	5	1,5	NB1616E3514UN
14	16	16	120	46,26	5	2	NB1616E4614UN
13	8	8	76	22,47	3	1,5	NB0808C2213UN
13	8	8	76	28,33	3	2	NB0808C2813UN
13	9,3	10	100	34,19	3	2,5	NB10093C3413UN

NB-UN

Hochleistungs-Innengewindefräser VHM+X.Cut Carbide HP Thread Mills+X.Cut Internal



- Für UNC/UNF Innengewinde
- UNC: Unified National Coarse
- UNF: Unified National Fine
- Gewinden, Entgraten in einem Zug
- Oberfläche X6.Cut beschichtet
- For internal UNC/UNF threads
- simultaneous threading/deburring
- With X6.Cut coating

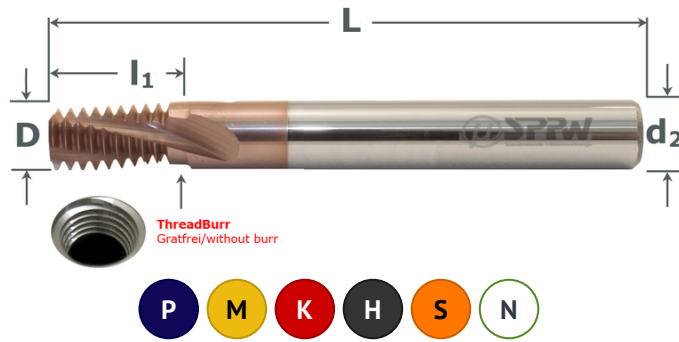

VHM	X Cut
z: 3-5	DIN 6535HA
Thread Burr	UN

Stg. TPI	ØD	Ød2	L	l1	z	nxØ	Art. No.
12	10	10	76	24,34	3	1,5	NB1010C2412UN
12	10	10	100	30,69	3	2	NB1010C3012UN
12	16	16	100	43,39	5	2	NB1616E4312UN
11	10	10	76	26,55	3	1,5	NB1010C2611UN
11	10	10	100	35,79	3	2	NB1010C3511UN
11	11,7	12	100	42,72	3	2,5	NB12117C4211UN
10	12	12	100	31,75	3	1,5	NB1212C3110UN
10	12	12	100	41,91	3	2	NB1212C4110UN

Stg. TPI	ØD	Ød2	L	l1	z	nxØ	Art. No.
9	16	16	100	38,1	3	1,5	NB1616C389UN
9	16	16	120	49,39	3	2	NB1616C499UN
8	16	16	100	42,86	3	1,5	NB1616C428UN
8	16	16	120	55,56	3	2	NB1616C558UN
8	20	20	120	49,21	4	1,5	NB2020D498UN
7	20	20	120	52,61	3	1,5	NB2020C527UN
6	25	25	130	61,38	3	1,5	NB2525C616UN

EB-M

Hochleistungs-Außengewindefräser VHM+X.Cut - M EXT Carbide HP Thread Mills+X.Cut External - M EXT



- Für metrische ISO-Außengewinde
- ThreadBurr
- Gewinden / Entgraten in einem Zug
- Oberfläche X6.Cut beschichtet
- For external metrical ISO-threads
- ThreadBurr
- Threading, deburring in 1 operation
- With X6.Cut coating

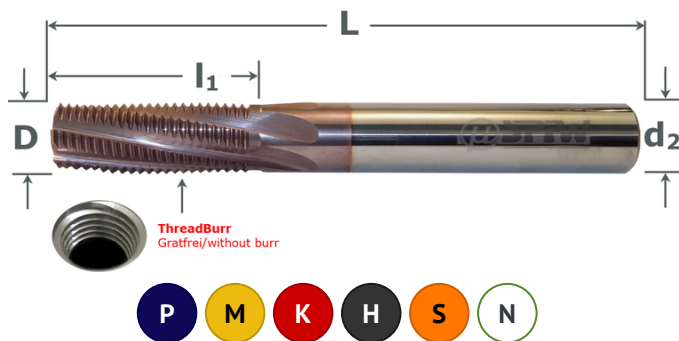

VHM	X Cut
EXT	DIN 6535HA
Thread Burr	M

Stg.	ØD	Ød2	L	l1	z	Art. No.
1	10	10	76	21,5	5	EB1010E2110ISO
1,5	12	12	83	26,25	5	EB1212E2615ISO
2	16	16	100	35	5	EB1616E3520ISO

XB-G

Hochleistungs-Gewindefräser VHM+X.Cut - G Carbide HP Thread Mills+X.Cut - G



- Für G Innen- und Außengewinde
- ThreadBurr
- Gewinden / Entgraten in einem Zug
- Oberfläche X6.Cut beschichtet
- For internal and external G threads
- ThreadBurr
- Threading and deburring in 1 operation
- With X6.Cut coating

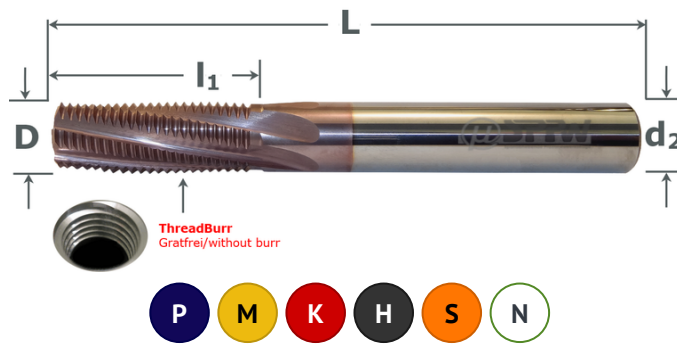

VHM	X Cut
INT EXT	DIN 6535HA
Thread Burr	G

Stg. TPI	ØD	Ød2	L	l1	z	Art. No.	Stg. TPI	ØD	Ød2	L	l1	z	Art. No.
28	6	6	63	10,43	3	XB0606C1028W	14	12	12	83	28,12	4	XB1212D2814W
28	8	8	63	14,06	4	XB0808D1428W	14	16	16	89	28,12	5	XB1616E2814W
19	8	8	63	15,37	3	XB0808C1519W	11	12	12	83	26,55	3	XB1212C2611W
19	10	10	76	22,06	4	XB1010D2219W	11	16	16	100	40,41	4	XB1616D4011W
14	12	12	83	20,86	4	XB1212D2014W	11	20	20	49,65	120	5	XB2020E4911W

XBT-G

Hochleistungs-Innengewindefräser VHM+X.Cut mit IK - G Carbide HP Coolant Feed Thread Mills+X.Cut Whitworth



- Typ XBT zentraler Kühlkanal
- Kühlmittelaustritt in der Spannutt
- Für Rohrgewinde, Innen/Außen
- Gewinden, Entgraten in einem Zug
- Oberfläche X6.Cut beschichtet
- Type XBT. central coolant bore
- Radial cooling through flutes
- For internal/external Whitworth
- Threading, deburring in 1 operation
- With X6.Cut coating

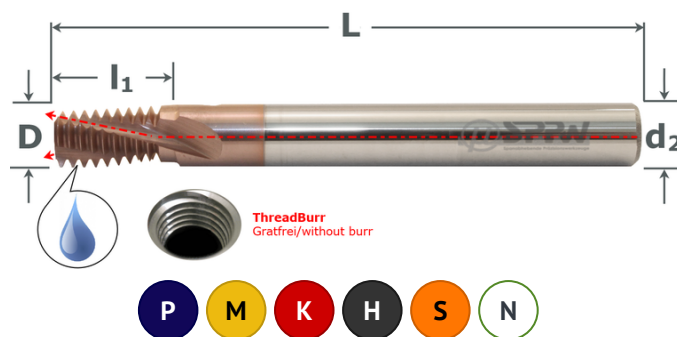

VHM	X Cut
z: 3-4	DIN 6535HA
Thread Burr	G pipe
IK cool	

Stg. TPI	ØD	Ød2	L	l1	z	Art. No.	Stg. TPI	ØD	Ød2	L	l1	z	Art. No.
28	6	6	76	10,43	3	XBT0606C1028W	14	12	12	100	28,12	4	XBT1212D2814W
19	10	10	100	22,06	4	XBT1010D2219W	11	16	16	100	40,41	4	XBT1616D4011W

XB-PG

Hochleistungs-Gewindefräser VHM+X.Cut - PG Carbide HP Thread Mills+X.Cut - PG



- Für PG Innen- und Außengewinde
- Gewinden und Entgraten in einem Zug
- Oberfläche X6.Cut beschichtet
- For internal and external PG threads
- Threading, deburring in 1 operation
- With X6.Cut coating

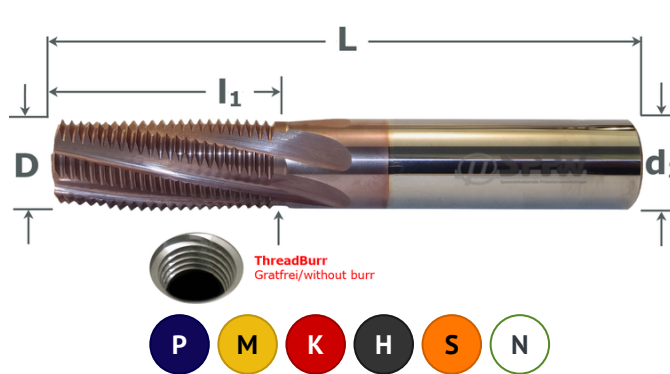

VHM	X Cut
INT EXT	z: 3-4
DIN 6535HA	Thread Burr
PG 80°	

Stg. TPI	ØD	Ød2	L	l1	z	Art. No.
20	8	8	63	27,52	3	XB0808C2120PG
18	10	10	76	27,52	3	XB1010C2718PG

Stg. TPI	ØD	Ød2	L	l1	z	Art. No.
16	12	12	83	30,96	4	XB1212D3116PG

XB-BSPT

Hochleistungs-Gewindefräser, konisch VHM+X.Cut - BSPT/Rc Carbide HP Thread Mills+X.Cut - BSPT/Rc



- Konische Innen-Außengewinde-BSPT
- Simultanes Gewinden, Entgraten
- Oberfläche X6.Cut beschichtet
- For internal/external threads-BSPT
- Threading, deburring in 1operation
- With X6.Cut coating

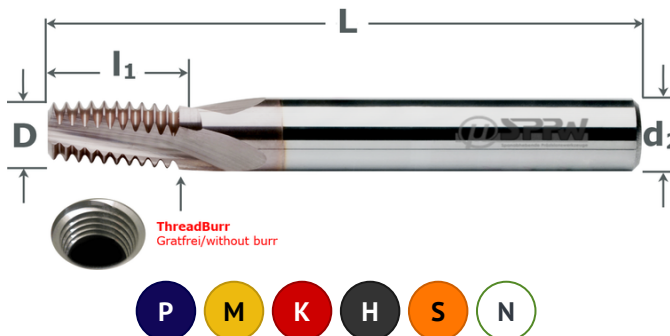

VHM	X Cut
INT EXT	DIN 6535HA
Thread Burr	BSPT Rc

Stg. TPI	ØD	Ød2	L	l1	z	Art. No.
28	6	6	63	10,43	3	XB0606C1028BSPT
28	8	8	63	14,06	4	XB0808D1428BSPT
19	8	8	63	15,37	3	XB0808C1519BSPT

Stg. TPI	ØD	Ød2	L	l1	z	Art. No.
19	10	10	76	22,06	4	XB1010D2219BSPT
14	12	12	83	20,86	4	XB1212D2014BSPT
11	16	16	89	31,17	4	XB1616D3111BSPT

L

XB-NPT

Hochleistungs-Gewindefräser, konisch VHM+X.Cut - NPT Carbide HP Thread Mills+X.Cut - NPT



- Konische Innen-/Außengewinde NPT
- Gewinden, Entgraten in einem Zug
- Oberfläche X6.Cut beschichtet

- Internal and external NPT threads
- Threading, deburring in 1 operation
- With X6.Cut coating

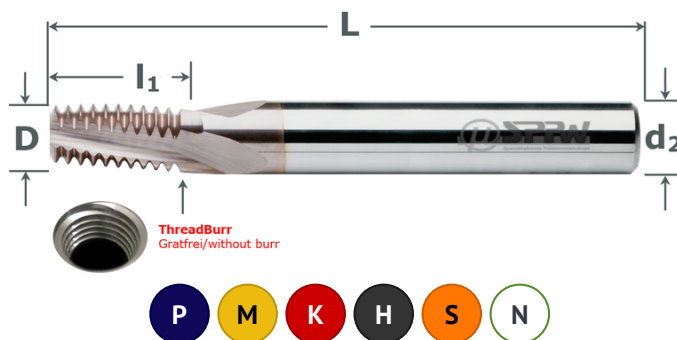

VHM	X Cut
INT EXT	z: 3-5
DIN 6535HA	Thread Burr
NPT	

Stg. TPI	ØD	Ød2	L	l1	z	Art. No.
27	6	6	63	10,82	3	XB0606C1027NPT
18	10	10	76	16,23	4	XB1010D1618NPT
18	8	8	63	16,23	3	XB0808C1618NPT
14	16	16	89	22,68	5	XB1616E2214NPT

Stg. TPI	ØD	Ød2	L	l1	z	Art. No.
14	12	12	83	22,68	4	XB1212D2214NPT
11,5	16	16	89	29,82	4	XB1616D29115NPT
8	20	20	100	42,86	4	XB2020D428NPT

XB-NPSF

Hochleistungs-Gewindefräser, konisch VHM+X.Cut - NPSF Carbide HP Thread Mills+X.Cut - NPSF



- Für gerade Innengewinde - NPSF
- Gewinden, Entgraten in einem Zug
- Oberfläche X6.Cut beschichtet
- Der Flankenwinkel beträgt 60°

- For internal, external threads
- Threading, deburring in 1 operation
- With X6.Cut coating

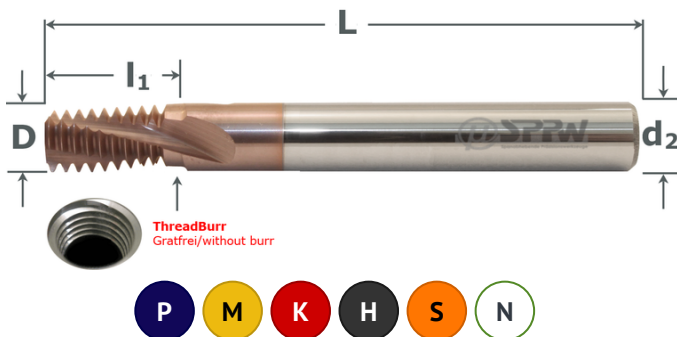

VHM	X Cut
INT EXT	z: 3-4
DIN 6535HA	Thread Burr
NPSF	

Stg. TPI	ØD	Ød2	L	l1	z	Art. No.
27	6	6	63	12,7	3	XB0606C1227NPSF
18	8	8	63	16,23	3	XB0808C1618NPSF

Stg. TPI	ØD	Ød2	L	l1	z	Art. No.
14	12	12	83	22,68	4	XB1212D2214NPSF
11,5	16	16	89	29,82	4	XB1616D29115NPSF

L

XB-NPTF

Hochleistungs-Gewindefräser, konisch VHM+X.Cut NPTF Carbide HP Thread Mills+X.Cut - NPTF



- Konische Innen-, Außengewinde
- Gewinden und Entgraten in einem Zug
- Oberfläche X6.Cut beschichtet
- Internal, external threads - NPTF
- Threading, deburring in 1operation
- With X6.Cut coating

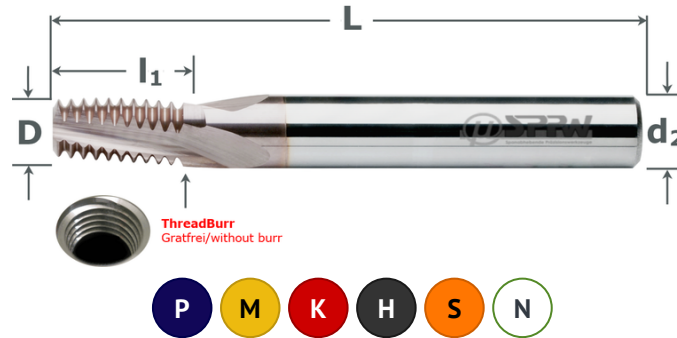

VHM	X Cut
INT EXT	z: 3-4
DIN 6535HA	Thread Burr
NPTF	



Stg. TPI	ØD	Ød2	L	l1	z	Art. No.	Stg. TPI	ØD	Ød2	L	l1	z	Art. No.
27	6	6	63	10,82	3	XB0606C1027NPTF	11,5	16	16	89	29,82	4	XB1616D29115NPTF
18	8	8	63	16,23	3	XB0808C1618NPTF	8	20	20	100	42,86	4	XB2020D428NPTF
14	12	12	83	22,68	4	XB1212D2214NPTF							

FC-NPT

Schaftfräser, konisch VHM+X.Cut 1:16 Steigung Carbide Conical End Mills+X.Cut Conicity 1:16



- Vorfräsen bei kegeligen Gewinden
- Typ BSPT, NPT, NPTF, NPTS
- Höhere Standzeit des Gewindefräasers
- Fasen des Gewindeeingangs
- Oberfläche X.Cut beschichtet
- For pre-milling of threads
- Type BSPT, NPT, NPTF, NPTS
- Increases tool life of thread mills
- Permits chamfering of the thread
- With X.Cut coating

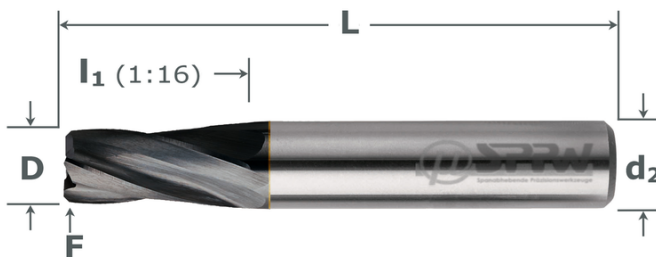

VHM	X Cut
INT EXT	z:4
DIN 6535HA	NPT BSPT
1:16	



ØD	a	Ød2	L	l1	z	F 45°	Art. No.	ØD	a	Ød2	L	l1	z	F 45°	Art. No.
5	1°47"	6	63	16	4	1	NPT0605D16FC	14	1°47"	16	89	32	4	2	NPT1614D32FC
8,5	1°47"	10	76	24	4	1,5	NPT10085D24FC	17	1°47"	20	120	48	4	3	NPT2017D48FC

— INFO

Schaftfräser zum Vorfräsen bei kegeligen Gewinden
Typ: BSPT, NPT, NPTF, NPSF

Conical End Mills for premilling of threads
Type: BSPT, NPT, NPTF, NPSF

ØD 5	NPT0605D16FC
ØD 8,5	NPT10085D24FC
ØD 14	NPT1614D32FC
ØD 17	NPT2017D48FC





- Für metrische ISO-Innengewinde
- Bohren, Gewindefräsen und Fasen
- Stabile Aufspannung notwendig
- Oberfläche X.Cut beschichtet
- For metrical ISO-threads
- Drilling, threading and chamfering
- Rigid clamping necessary
- With X.Cut coating

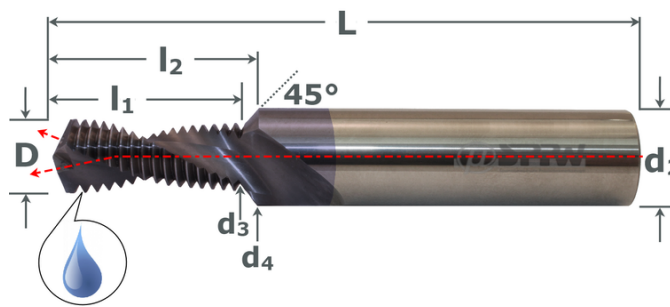

VHM	X Cut
INT	z:2
DIN 6535HA	M
IK cool	

Stg.	M	ØD	L	l1	l2	Ød2	Ød3	Ød4	Art. No.
0,8	M5	4,2	55	7,15	9,4	6	4,04	5,3	NDFK06042B0708ISOX
0,8	M5	4,2	55	9,55	11,8	6	4,04	5,3	NDFK06042B0908ISOX
1	M6	5	65	9,05	11,66	8	4,8	6,3	NDFK08050B0910ISOX
1	M6	5	65	12,05	14,66	8	4,8	6,3	NDFK08050B1210ISOX
1	M6	5	65	14,9	17,65	8	4,8	6,3	NDFK08050B1410ISOX
1,25	M8	6,75	75	11,32	14,64	10	6,5	8,3	NDFK10067B11125ISOX
1,25	M8	6,75	75	15,07	18,39	10	6,5	8,3	NDFK10067B15125ISOX
1,25	M8	6,75	82	19,9	23,4	10	6,5	8,3	NDFK10067B19125ISOX
1,5	M10	8,5	82	15,08	19,11	12	8,2	10,3	NDFK12085B1515ISOX
1,5	M10	8,5	82	19,58	23,61	12	8,2	10,3	NDFK12085B19150ISOX
1,5	M10	8,5	82	23,9	28,1	12	8,2	10,3	NDFK12085B2315ISOX
1,75	M12	10,25	82	17,6	22,33	14	9,9	12,3	NDFK14102B17175ISOX
1,75	M12	10,25	89	22,85	27,58	14	9,9	12,3	NDFK14102B22175ISOX
1,75	M12	10,25	95	29,6	34,6	14	9,9	12,3	NDFK14102B29175ISOX
2	M14	12	102	20,11	25,54	16	11,6	14,3	NDFK16120B2020ISOX
2	M14	12	106	28,11	33,54	16	11,6	14,3	NDFK16120B2820ISOX
2	M14	12	110	35,85	41,55	16	11,6	14,3	NDFK16120B3520ISOX
2	M16	14	102	24,11	29,91	18	13,6	16,3	NDFK18140B2420ISOX
2	M16	14	106	32,11	37,91	18	13,6	16,3	NDFK18140B3220ISOX
2	M16	14	110	39,85	45,95	18	13,6	16,3	NDFK18140B3920ISOX





- Grundkörper mit gerader Platte
- Typ A: 1 WSP
- Typ B: 2 WSP
- Typ C: 4-5 WSP
- Auslieferung ohne Platten
- Lieferzeit ca. 5 - 8 Arbeitstage

- Body with straight inserts
- Type A: 1 insert
- Type B: 2 inserts
- Type C: 4-5 inserts
- Body will be sold without inserts
- Delivery time 5 - 8 working days

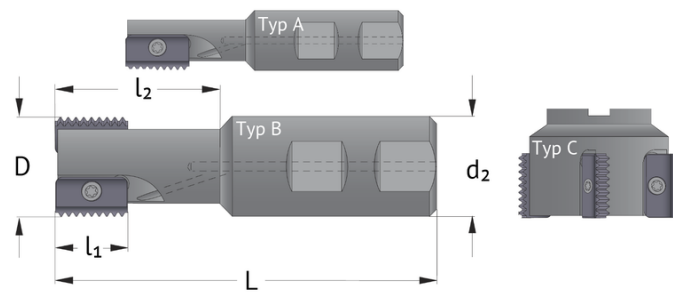

STEEL	BODY
Typ SR	DIN 6535HB
modul R	

ØD	Ød2	L	l1	l2	z	Typ	Art. No.
12	20	75	14	20	1	A	SR0012F14
14,5	20	85	14	25	1	A	SR0014H14
17	20	85	14	30	1	A	SR0017H14
18	20	85	21	30	1	A	SR0018H21
20	20	93	14	41	2	B	SR0020H142
21	20	94	21	40	1	A	SR0021H21
25	20	125	21		1	A	SR0025K21
29	25	110	30	50	1	A	SR0029J30
30	25	108	21	52	2	B	SR0030J212
31	25	150	30		1	A	SR0031M30
38	32	150	30		1	A	SR0038M30

ØD	Ød2	L	l1	l2	z	Typ	Art. No.
40	32	130	30	70	2	B	SR0040L302
48	40	153	40	78	1	A	SR0048M40
48	40	210	40		1	A	SR0048R40
50	40	153	40	78	2	B	SR0050M402
63	22	50	21	--	5	C	SR0063C215
63	22	50	30	--	4	C	SR0063C304
80	27	55	30	--	4	C	SR0080D304
80	27	65	40	--	4	C	SR0080D404
100	32	60	30	--	4	C	SR0100D304
100	32	70	40	---	4	C	SR0100E404



- Gewindefräser mit 1 Schneidplatte
- Verschiedene Gewinde mit WSP
- Auslieferung ohne Platte
- Lieferzeit ca. 5 - 8 Arbeitstage

- Body with straight insert
- Inserts for multiple threads
- Body will be sold without insert
- Delivery time 5 - 8 working days

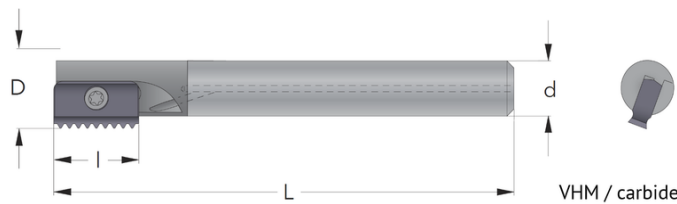

VHM	BODY
Typ SR	DIN 6535HB
modul R	

ØD	Ød2	L	l1	l2	z	Art. No.
13	10	150	14		1	SR0013J14C
15	12	175	14		1	SR0015K14C
21	16	200	21		1	SR0021M21C

ØD	Ød2	L	l1	l2	z	Art. No.
27	20	260	30		1	SR0027S30C
33	25	270	30		1	SR0033T30C





- Gewinde-Fräsplatten
- Gewindeprofil: M
- Oberfläche X.Cut beschichtet
- Lieferzeit ca. 5 - 8 Arbeitstage
- Micrograin thread milling inserts
- Thread profile: M
- With X.Cut coating
- Delivery time 5 - 8 working days

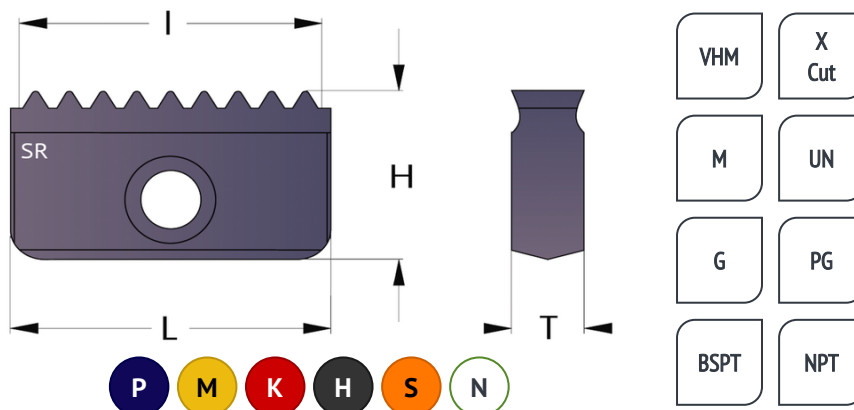

M - Metrisch | metric

Stg.	L	l	H	T	z	Art. No.
1	14	14	3,1	7,5	2	14I10ISOFC
1,5	14	13,5	3,1	7,5	2	14I15ISOFC
2	14	14	3,1	7,5	2	14I20ISOFC
2,5	14	12,5	3,1	7,5	2	14I25ISOFC
1	21	21	4,7	12	2	21I10ISOFC
1,5	21	21	4,7	12	2	21I15ISOFC
2	21	20	4,7	12	2	21I20ISOFC
3	21	21	4,7	12	2	21I30ISOFC
3,5	21	21	4,7	12	2	21I35ISOFC
1,5	30	30	5,5	16	2	30I15ISOFC

Stg.	L	l	H	T	z	Art. No.
2	30	30	5,5	16	2	30I20ISOFC
3	30	30	5,5	16	2	30I30ISOFC
4	30	28	5,5	16	2	30I40ISOFC
4,5	30	27	5,5	16	2	30I45ISOFC
5	30	30	5,5	16	2	30I50ISOFC
2	40	40	6,3	20	2	40I20ISOFC
3	40	39	6,3	20	2	40I30ISOFC
4	40	40	6,3	20	2	40I40ISOFC
6	40	36	6,3	20	2	40I60ISOFC

UN - Unified National

Stg.	L	l	H	T	z	Art. No.
12	14	12,7	3,1	7,5	2	14I12UNFC
14	14	12,7	3,1	7,5	2	14I14UNFC
16	14	12,7	3,1	7,5	2	14I16UNFC
18	14	14,11	3,1	7,5	2	14I18UNFC
20	14	13,97	3,1	7,5	2	14I20UNFC
24	14	13,75	3,1	7,5	2	14I24UNFC
12	21	21,12	4,7	12	2	21I12UNFC
16	21	20,64	4,7	12	2	21I16UNFC
18	21	21,17	4,7	12	2	21I18UNFC
20	21	20,32	4,7	12	2	21I20UNFC

Stg.	L	l	H	T	z	Art. No.
7	21	21,77	4,7	12	2	21I7UNFC
8	21	19,05	4,7	12	2	21I8UNFC
12	30	29,63	5,5	16	2	30I12UNFC
16	30	30,16	5,5	16	2	30I16UNFC
5	30	30	5,5	16	1	30I5UNFC
6	30	29,63	5,5	16	2	30I6UNFC
8	30	28,57	5,5	16	2	30I8UNFC
12	40	40,22	6,3	20	2	40I12UNFC
6	40	38,1	6,3	20	2	40I6UNFC
8	40	38,1	6,3	20	2	40I8UNFC

G - Whitworth

Stg.	L	l	H	T	z	Art. No.
14	14	12,7	3,1	7,5	2	14X14WFC
19	14	13,37	3,1	7,5	2	14X19WFC
11	21	20,78	4,7	12	2	21X11WFC

Stg.	L	l	H	T	z	Art. No.
14	21	19,96	4,7	12	2	21X14WFC
11	30	30,02	5,5	16	2	30X11WFC
11	40	39,25	6,3	20	2	40X11WFC



- Gewinde-Fräsplatten
- Gewindeprofil: M
- Oberfläche X.Cut beschichtet
- Lieferzeit ca. 5 - 8 Arbeitstage
- Micrograin thread milling inserts
- Thread profile: M
- With X.Cut coating
- Delivery time 5 - 8 working days

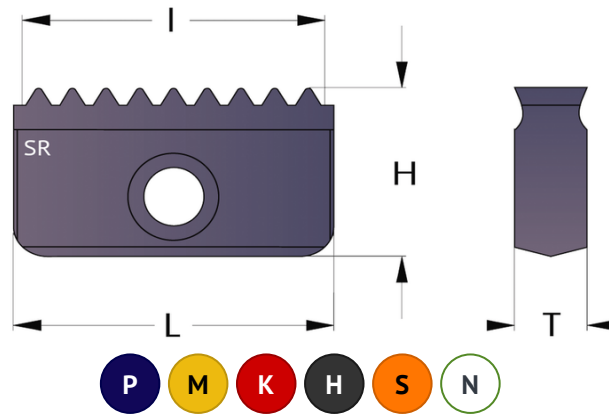

VHM	X Cut
M	UN
G	PG
BSPT	NPT

PG - Panzergewinde

Stg.	L	l	H	T	z	Art. No.
18	14	14,11	3,1	7,5	2	14X18PGFC
16	21	20,64	4,7	12	2	21X16PGFC

Stg.	L	l	H	T	z	Art. No.
18	21	21	4,7	12	2	21X18PGFC
16	30	30	5,5	16	2	30X16PGFC

BSPT - British Standard Pipe Taper

Stg.	L	l	H	T	z	Art. No.
14	14	12,7	3,1	7,5	1	14X14BSPTFC
19	14	13,37	3,1	7,5	1	14X19BSPTFC
11	21	20,78	4,7	12	1	21X11BSPTFC

Stg.	L	l	H	T	z	Art. No.
14	21	19,96	4,7	12	1	21X14BSPTFC
11	30	30,02	5,5	16	1	30X11BSPTFC
11	40	39,25	6,3	20	1	40X11BSPTFC

NPT - National Pipe Taper

Stg.	L	l	H	T	z	Art. No.
14	14	12,7	3,1	7,5	1	14X14NPTFC
18	14	12,7	3,1	7,5	1	14X18NPTFC
11,5	21	19,88	4,7	12	1	21X11,5NPTFC

Stg.	L	l	H	T	z	Art. No.
14	21	19,96	4,7	12	1	21X14NPTFC
11,5	30	28,71	5,5	16	1	30X11,5NPTFC
8	40	38,1	6,3	20	1	40X8NPTFC

NPTF - National Pipe Taper Fuel

Stg.	L	l	H	T	z	Art. No.
14	14	12,7	3,1	7,5	1	14X14NPTFFC
18	14	12,7	3,1	7,5	1	14X18NPTFFC
11,5	21	19,88	4,7	12	1	21X11,5NPTFFC

Stg.	L	l	H	T	z	Art. No.
14	21	19,96	4,7	12	1	21X14NPTFFC
11,5	30	28,71	5,5	16	1	30X11,5NPTFFC
8	40	38,1	6,3	20	1	40X8NPTFFC



SRH

Grundkörper für Gewindefräser mit gedrahten Schneidplatten Body for Thread Mills with Spiral Inserts



- Grundkörper mit gedrahten Platten
- Plattenwechsel: verschiedene Gewinde
- Auslieferung ohne Platten
- Lieferzeit ca. 5-8 Arbeitstage
- Body with spiral inserts
- Changing the inserts: multiple threads
- Body will be sold without inserts
- Delivery time 5-8 working days

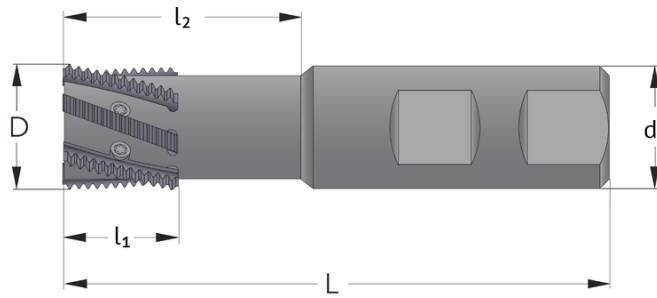

STEEL	BODY
Typ SRH	DIN 6535HB
modul R	

ØD	Ød2	L	l1	l2	z	Art. No.	ØD	Ød2	L	l1	l2	z	Art. No.
23	25	110	27	50	2	SRH232	45	32	130	37	-	6	SRH456
32	32	130	32	60	5	SRH325							

SRHM

Grundkörper für Gewindefräser mit gedrahten Schneidplatten Carbide Body for Multipocket Thread Mills with Spiral Inserts



- Grundkörper, Multipocket Gewindefräser
- Mit spiralen Schneidplatten
- Auslieferung ohne Platten
- Lieferzeit ca. 5-8 Arbeitstage
- Body for multipocket thread mills
- With spiral inserts
- Body will be sold without inserts
- Delivery time 5-8 working days

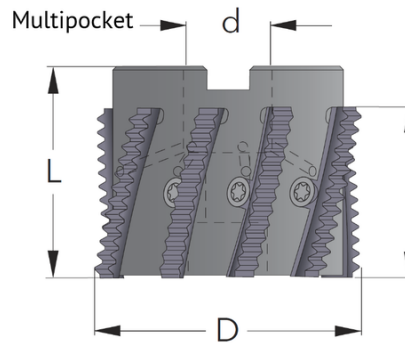

STEEL	BODY
SRH Multi	modul R

Multiflute

ØD	ØB	L	l1	l2	z	Art. No.	ØD	ØB	L	l1	l2	z	Art. No.
32	16	52	32		5	SRHM325	63	22	50	38		9	SRHM639
45	22	60	37		6	SRHM456							



- Gewinde-Fräsplatten
- Für gedrehte Gewindefräser
- Gewindeprofil: M
- Oberfläche X.Cut beschichtet
- Lieferzeit ca. 5 - 8 Arbeitstage
- Micrograin thread milling inserts
- For helix thread mills
- Thread profile: M
- With X.Cut coating
- Delivery time 5 - 8 working days

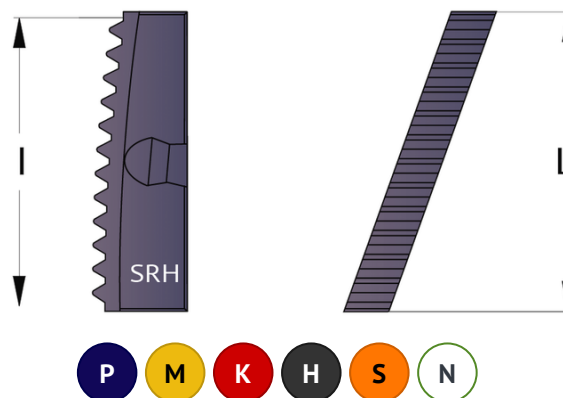

VHM	X Cut
M	UN
G	NPT
BSPT	

M - Metrisch | metric

Stg.	L	l	z	Art. No.	Stg.	L	l	z	Art. No.
1	27	27	1	H23110ISOFC	1,5	37	36	1	H45115ISOFC
1,5	27	27	1	H23115ISOFC	2	37	36	1	H45120ISOFC
2	27	26	1	H23120ISOFC	3	37	36	1	H45130ISOFC
3	27	27	1	H23130ISOFC	4	37	36	1	H45140ISOFC
1,5	32	31,5	1	H32115ISOFC	1,5	38	37,5	1	H63115ISOFC
2	32	32	1	H32120ISOFC	2	38	38	1	H63120ISOFC
3	32	30	1	H32130ISOFC	3	38	36	1	H63130ISOFC
4	32	32	1	H32140ISOFC	4	38	36	1	H63140ISOFC

UN - Unified

Stg.	L	l	z	Art. No.	Stg.	L	l	z	Art. No.
12	27	25,4	1	H23112UNFC	6	32	29,63	1	H3216UNFC
16	27	26,99	1	H23116UNFC	8	32	31,75	1	H3218UNFC
18	27	26,81	1	H23118UNFC	12	37	35,98	1	H45112UNFC
20	27	26,67	1	H23120UNFC	16	37	36,51	1	H45116UNFC
24	27	26,46	1	H23124UNFC	6	37	33,97	1	H4516UNFC
7	27	25,4	1	H2317UNFC	8	37	34,93	1	H4518UNFC
8	27	25,4	1	H2318UNFC	12	38	38,1	1	H63112UNFC
12	32	31,75	1	H32112UNFC	16	38	38,1	1	H63116UNFC
16	32	31,75	1	H32116UNFC	6	38	38,1	1	H6316UNFC
18	32	31,04	1	H32118UNFC	8	38	38,1	1	H6318UNFC
20	32	31,75	1	H32120UNFC					

NPT - National Pipe Taper

Stg.	L	l	z	Art. No.	Stg.	L	l	z	Art. No.
11,5	27	26,5	1	H23X115NPTFC	11,5	37	35,34	1	H45X115NPTFC
11,5	32	30,92	1	H32X115NPTFC					





[DE] **Gewinden**
[EN] **Threading**



passion for precision
[Leidenschaft für Präzision]



Mini-Gewindeformer und Gewindebohrer

HSS-E Mini Taps and Forming Taps

Art.No./Page

		HSS E05	A Cut	DIN 371	Form C	Iso2 6HX	M	Former Mini	360 491 Seite M 1
		HSS PM	X Cut	DIN 371	Form B	Iso2 6HX	M	Mini	360 421 Seite M 1

FlashCut - Gewindeformer und Gewindebohrer

FlashCut Taps and Forming Taps

Art.No./Page





		HSS E05	X Nit	DIN 371	Form B	DIN 374	Iso2 6H	DIN 376	M MF	360 620 Seite M 2
		HSS E05	X Nit	DIN 371	Form C35	DIN 374	Iso2 6H	DIN 376	M MF	360 650 Seite M 3
		HSS E05	A Cut	DIN 371	Form B	DIN 374	Iso2 6H	DIN 376	M MF	360 520 Seite M 4
		HSS E05	A Cut	DIN 371	Form C35	DIN 374	Iso2 6H	DIN 376	M MF	360 550 Seite M 4
		HSS PM	C Cut	DIN 371	Form C	DIN 374	Iso2 6HX	DIN 376	M MF	360 490 Seite M 5
		HSS PM	C Cut	DIN 371	Form B	DIN 374	Iso2 6H	DIN 376	M MF	360 420 Seite M 6
		HSS PM	C Cut	DIN 371	Form C35	DIN 374	Iso2 6H	DIN 376	M MF	360 450 Seite M 6
		HSS PM	A Cut	DIN 371	Form C	DIN 374	Iso2 6HX	DIN 376	M MF	360 190 Seite M 7
		HSS PM	A Cut	DIN 371	Form B	DIN 374	Iso2 6H	DIN 376	M MF	360 120 Seite M 8
		HSS PM	A Cut	DIN 371	Form C35	DIN 374	Iso2 6H	DIN 376	M MF	360 150 Seite M 8
		HSS PM	C Cut	DIN 371	Form C	DIN 374	Iso2 6H	DIN 376	M MF	360 310 Seite M 9
		HSS E05	blank	DIN 371	Form C	DIN 374	Iso2 6H	DIN 376	M MF	360 210 Seite M 9
		HSS PM	X Cut	Form D	Iso2 6HX	M MF	52 HRC		360 510 Seite M 10	
		HSS PM	C Cut	Form B	Iso2 6HX	M MF	Titan		360 721 Seite M 10	

Gewindebohrer HSS/-E - Metrisch, Sonderformen

HSS-E Taps - Miscellaneous

Art.No./Page





		HSS E05	X Cut	DIN 371	Form B	Iso2 6H	DIN 376	M	AL	360 125 Seite M 11
		HSS E05	X Cut	DIN 371	Form C35	Iso2 6H	DIN 376	M	AL	360 165 Seite M 11

○	●										HSS E05	X Cut	DIN 371	Form B	Iso2 6H	DIN 376	M	360 525 Seite M 12	
○	●										HSS E05	X Cut	DIN 371	Form C40	Iso2 6H	DIN 376	M	360 555 Seite M 12	
●	●			○							HSS E05	blank	Form B	Iso2 6H	ZYL	L lang	M	306 100 Seite M 13	
●	●			○							HSS E05	blank	Form C35	Iso2 6H	ZYL	L lang	M	306 300 Seite M 13	
●	●			○							HSS E05	blank	DIN 371	Form B	DIN 376	Iso2 6G	ZYL	M	334 300 Seite M 14

Gewindebohrer HSS-E - Andere Gewinde

HSS-E Taps - Other Thread Profiles

Art.No./Page

●	●			○							HSS E05	blank	DIN 5156	Form C	ZYL	G	313 400 Seite M 14
●	●			○							HSS E05	blank	DIN 371	Form C	ZYL	UNC UNF	312 800 Seite M 15
●	●			○							HSS	blank	Form C	ZYL	NPT	324 500 Seite M 15	
●	●			○							HSS	blank	Form C	ZYL	BSPT	324 600 Seite M 16	

Handgewindebohrer-Sätze

HSS Hand Taps

Art.No./Page

●	●										HSS	Nit X	DIN 352	Form A-D-C	ZYL	Hand	M	311 602 Seite M 16
---	---	--	--	--	--	--	--	--	--	---	-----	-------	---------	------------	-----	------	---	------------------------------

Schneideisen HSS /-E

HSS / HSS-E Dies

Art.No./Page

●	●										HSS E05	Nit X	EN 22568	Form B	ISO 6g	M	300 502 Seite M 17
---	---	--	--	--	--	--	--	--	--	---	---------	-------	----------	--------	--------	---	------------------------------

— INFO —

Wir liefern **Sonderanfertigungen** in Ihrer gewünschten Abmessung!

Fragen Sie an!

We also supply **special tools** in your desired dimensions !

Please send us your inquiry!



360 491**Mini-Gewindeformer HSS-E+A.Cut M**
HSS-E Mini Forming Taps+A.Cut M

- Stähle mit guter Kaltverformbarkeit
- Grund- und DL bis $2x\emptyset$
- Stabile Ausführung ohne Kühlnuten
- Oberfläche A.Cut beschichtet
- Lieferzeit 3 - 5 Arbeitstage

- Steels, good cold forming properties
- Through and blind holes $2x\emptyset$
- Especially rigid, without oil grooves
- With A.Cut coating
- Delivery time 3 - 5 working days



HSS E05	A Cut
DIN 371	Form C
Iso2 6HX	M
Former Mini	

M	Stg TPI	L	l1	$\emptyset d2$	$\emptyset a$	Art. No.
1,0	0,25	40	4	2,5	2,1	3604910100
1,2	0,25	40	4,8	2,5	2,1	3604910120
1,4	0,3	40	5,6	2,5	2,1	3604910140
1,6	0,35	40	6,4	2,5	2,1	3604910160

M	Stg TPI	L	l1	$\emptyset d2$	$\emptyset a$	Art. No.
1,7	0,35	40	6,8	2,5	2,1	3604910170
1,8	0,35	40	7,2	2,5	2,1	3604910180
2,0	0,4	45	8	2,8	2,1	3604910200
2,5	0,45	50	9	2,8	2,1	3604910250

360 421**Mini-Gewindebohrer Pulvermetall+X.Cut M**
HP Powder Metal Mini Taps+X.Cut M

- Allgemeine Anwendung
- Schälanschnitt für DL bis $3x\emptyset$
- Langer Anschnitt 3-5 Gang
- Verstärkter Schaft
- Oberfläche X.Cut beschichtet

- General use
- Spiral point for through holes $3x\emptyset$
- Long chamfer 3-5 threads
- Reinforced shank
- With X.Cut coating



HSS PM	X Cut
DIN 371	Form B
Iso2 6HX	M
Mini	

M	Stg TPI	L	l1	$\emptyset d2$	$\emptyset a$	Art. No.
1,0 5HX	0,25	40	5,5	2,5	2,1	3604210100
1,2 5HX	0,25	40	5,5	2,5	2,1	3604210120
1,4 5HX	0,3	40	7	2,5	2,1	3604210140
1,6 6HX	0,35	40	8	2,5	2,1	3604210160

M	Stg TPI	L	l1	$\emptyset d2$	$\emptyset a$	Art. No.
1,7 6HX	0,35	40	8	2,5	2,1	3604210170
1,8 6HX	0,35	40	8	2,5	2,1	3604210180
2,0 6HX	0,4	45	7	2,8	2,1	3604210200
2,5 6HX	0,45	50	9	2,8	2,1	3604210250

360 620**Universal-Gewindebohrer HSS-E+X.Nit [M/MF]
HSS-E Universal-Taps X.Steam [M/MF]**

- Breites Anwendungsfeld
- Schälanschnitt für DL bis 2,5xØ
- Langer Anschnitt 3-5 Gang
- Flankenhinterschliff
- Bis M10 mit verstärktem Schaft
- Oberfläche vaporisiert X.Nit
- Universal application tap
- Spiral point for through holes 2,5xØ
- Long chamfer 3-5 threads
- Reduced torque due to back taper
- Up to M10 with reinforced shank
- Steam tempered

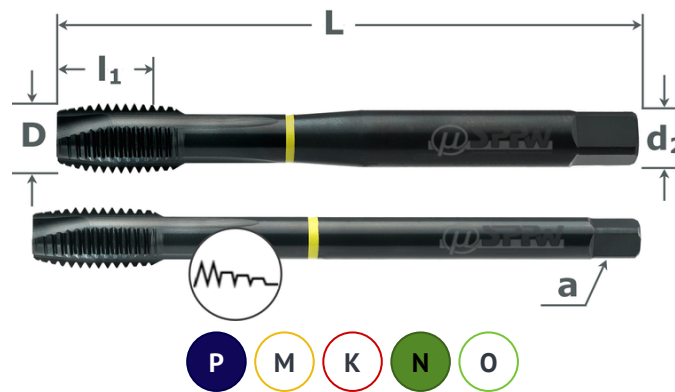

HSS E05	X Nit
DIN 371	Form B
DIN 374	Iso2 6H
DIN 376	M MF

360620 - verstärkter Schaft | reinforced shank

M/MF	Stg TPI	L	l1	Ød2	Øa	Art. No.
2	0,4	45	10	2,8	2,1	3606200200
2,5	0,45	50	10	2,8	2,1	3606200250
3	0,5	56	7	3,5	2,7	3606200300
3,5	0,6	56	8,4	4	3	3606200350
4	0,7	63	10	4,5	3,4	3606200400
4	0,5	63	10	4,5	3,4	3606200405
5	0,8	70	11,2	6	4,9	3606200500
5	0,5	70	11,2	6	4,9	3606200505
6	1	80	14	6	4,9	3606200600
6	0,75	80	14	6	4,9	3606200607
8	1,25	90	17,5	8	6,2	3606200800
8	1	93	18	6	5	3606200810
10	1,5	100	21	10	8	3606201000
10	1	90	18	7	6	3606201010
10	1,25	100	20	7	6	3606201012

M/MF	Stg TPI	L	l1	Ød2	Øa	Art. No.
12	1,75	110	22	9	7	3606201200
12	1	100	22	9	7	3606201210
12	1,25	100	22	9	7	3606201212
12	1,5	100	22	9	7	3606201215
14	2	110	25	11	9	3606201400
14	1	100	22	11	9	3606201410
14	1,25	100	22	11	9	3606201412
14	1,5	100	22	11	9	3606201415
16	2	110	28	12	9	3606201600
16	1	100	22	12	9	3606201610
16	1,25	100	22	12	9	3606201612
18	2,5	125	32	14	11	3606201800
20	2,5	140	32	16	12	3606202000
22	2,5	140	32	18	14,5	3606202200
24	3	160	32	18	14,5	3606202400

360620UE - Überlaufschaft | reduced shank

M/MF	Stg TPI	L	l1	Ød2	Øa	Art. No.
3	0,5	56	10	2,7	2,1	3606200300UE
4	0,7	63	12	2,8	3,4	3606200400UE
5	0,8	70	13,5	3,5	4,9	3606200500UE

M/MF	Stg TPI	L	l1	Ød2	Øa	Art. No.
6	1	80	15,5	4,5	4,9	3606200600UE
8	1,25	90	17	6	6,2	3606200800UE
10	1,5	100	20	7	5,5	3606201000UE



360 650

Universal-Gewindebohrer HSS-E+X.Nit [M/MF] HSS-E Universal Taps X.Nit [M/MF]



- Breites Anwendungsfeld
- Gedrallt für Grundlöcher bis 2,5xØ
- Kurzer Anschnitt 2-3 Gang
- Flankenhinterschliff
- Bis M10 mit verstärktem Schaft
- Oberfläche vaporisiert

- Universal use tap
- Spiral flute for blind holes 2,5xØ
- Short chamfer 2-3 threads
- Reduced torque due to back taper
- Up to M10 with reinforced shank
- Steam tempered

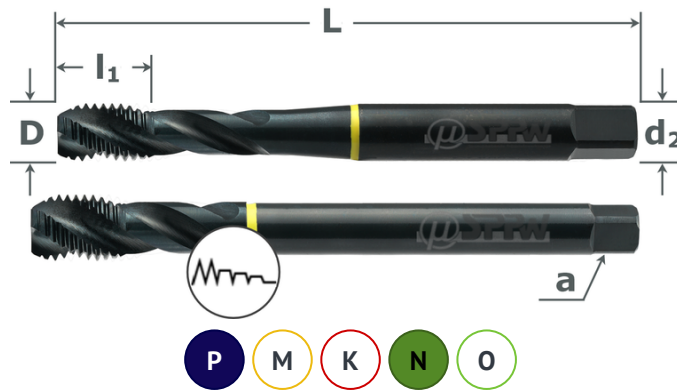

HSS E05	X Nit
DIN 371	Form C35
DIN 374	Iso2 6H
DIN 376	M MF

360650 - verstärkter Schaft | reinforced shank

M/MF	Stg TPI	L	l1	Ød2	Øa	Art. No.
2	0,4	45	10	2,8	2,1	3606500200
2,5	0,45	50	10	2,8	2,1	3606500250
3	0,5	50	7	3,5	2,1	3606500300
3,5	0,6	56	8,4	4	3	3606500350
4	0,7	63	10	4,5	3,4	3606500400
5	0,8	70	11,2	6	4,9	3606500500
6	1	80	14	6	4,9	3606500600
8	1,25	90	17,5	8	6,2	3606500800
8	1	90	17,5	8	4,9	3606500810
10	1,5	100	21	10	8	3606501000
10	1	90	12	7	5,5	3606501010
10	1,25	100	14	7	5,5	3606501012
12	1,75	110	16	9	7	3606501200

M/MF	Stg TPI	L	l1	Ød2	Øa	Art. No.
12	1	100	14	9	7	3606501210
12	1,25	100	14	9	7	3606501212
12	1,5	100	14	9	7	3606501215
14	2	110	18	11	9	3606501400
14	1	100	16	11	9	3606501410
14	1,25	100	16	11	9	3606501412
14	1,5	100	18	11	9	3606501415
16	2	110	18	12	9	3606501600
16	1,5	110	18	12	9	3606501615
18	2,5	125	25	14	11	3606501800
20	2,5	140	25	16	12	3606502000
22	2,5	140	25	18	14,5	3606502200
24	3	160	30	18	14,5	3606502400

360650 UE - Überlaufschaft | reduced shank

M/MF	Stg TPI	L	l1	Ød2	Øa	Art. No.
4	0,7	63	7	2,8	2,1	3606500400UE
5	0,8	70	8,5	3,5	2,7	3606500500UE
6	1	80	9,5	3,5	2,7	3606500600UE

M/MF	Stg TPI	L	l1	Ød2	Øa	Art. No.
8	1,25	90	10	6	4,9	3606500800UE
10	1,5	100	14	7	5,5	3606501000UE

M

360 520

HP-Gewindebohrer HSS-E+A.Cut M/MF - Stahl HSS-E Taps+A.Cut M/MF - Steel



- Stähle bis 950 N/mm²
- Schälanschnitt für DL bis 2,5xØ
- Langer Anschnitt 3-5 Gang
- Flankenhinterschliff
- Bis M10 mit verstärktem Schaft
- Oberfläche A.Cut beschichtet

- Steels up to 950 N/mm²
- Spiral point for through holes 2,5xØ
- Long chamfer 3-5 threads
- Reduced torque due to back taper
- Up to M10 with reinforced shank
- With A.Cut coating

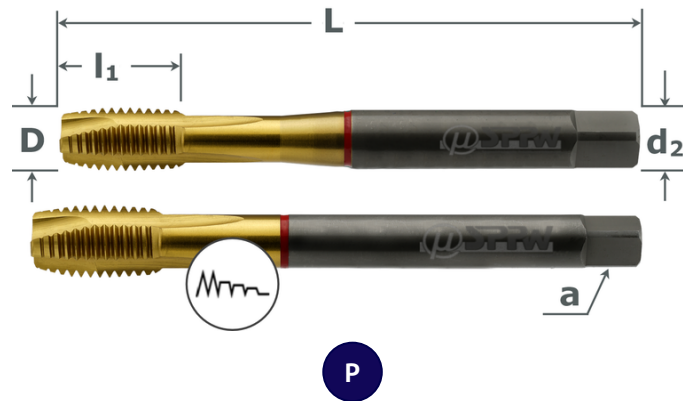

HSS E05	A Cut
DIN 371	Form B
DIN 374	Iso2 6H
DIN 376	M MF

M/MF	Stg TPI	L	l1	Ød2	Øa	Art. No.	M/MF	Stg TPI	L	l1	Ød2	Øa	Art. No.
3	0,5	56	10	3,5	2,7	3605200300	10	1	90	18	10	8	3605201010
4	0,7	63	12	4,5	3,4	3605200400	12	1,75	110	22	9	7	3605201200
5	0,8	70	14	6	4,9	3605200500	12	1,5	100	22	9	7	3605201215
6	1	80	16	6	4,9	3605200600	14	2	110	25	11	9	3605201400
8	1,25	90	18	8	6,2	3605200800	14	1,5	100	22	11	9	3605201415
8	1	90	18	8	6,2	3605200810	16	2	110	28	12	9	3605201600
10	1,5	100	20	10	8	3605201000							

360 550

HP-Gewindebohrer HSS-E+A.Cut M/MF - Stahl HP HSS-E Taps+A.Cut M/MF - Steel



- Stähle bis 950 N/mm²
- Gedrallt für Grundlöcher bis 2,5xØ
- Kurzer Anschnitt Form D, 2-3 Gang
- Gerade Flanken
- Bis M10 mit verstärktem Schaft
- Oberfläche A.Cut beschichtet

- Steels up to 950 N/mm²
- Spiral flutes for blind holes 2,5xØ
- Short chamfer 2-3 threads
- Reduced torque due to back chamfer
- Up to M10 with reinforced shank
- With A.Cut coating

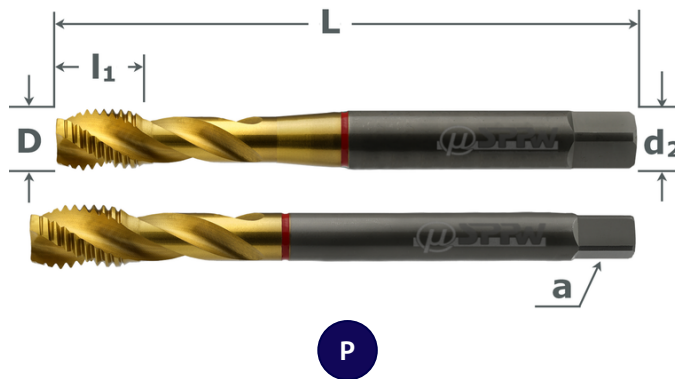

HSS E05	A Cut
DIN 371	Form C35
DIN 374	Iso2 6H
DIN 376	M MF

M/MF	Stg TPI	L	l1	Ød2	Øa	Art. No.	M/MF	Stg TPI	L	l1	Ød2	Øa	Art. No.
3	0,5	56	5	3,5	2,7	3605500300	10	1	90	14	10	8	3605501010
4	0,7	63	7	4,5	3,4	3605500400	12	1,75	110	16	9	7	3605501200
5	0,8	70	9	6	4,9	3605500500	12	1,5	100	14	9	7	3605501215
6	1	80	10	6	4,9	3605500600	14	2	110	18	11	9	3605501400
8	1,25	90	12	8	6,2	3605500800	14	1,5	100	18	11	9	3605501415
8	1	90	12	8	6,2	3605500810	16	2	110	18	12	9	3605501600
10	1,5	100	14	10	8	3605501000							

M



- Rostfreie Stähle
- Grund- und DL bis $2 \times \emptyset$
- Kühlnuten für Schmiermitteltransport
- Bis M10 nach DIN 371
- Oberfläche C.Cut beschichtet
- Stainless steels
- Through and blind holes $2 \times \emptyset$
- Oil grooves for better lubrication
- Up to M10 with reinforced shank
- With C.Cut coating

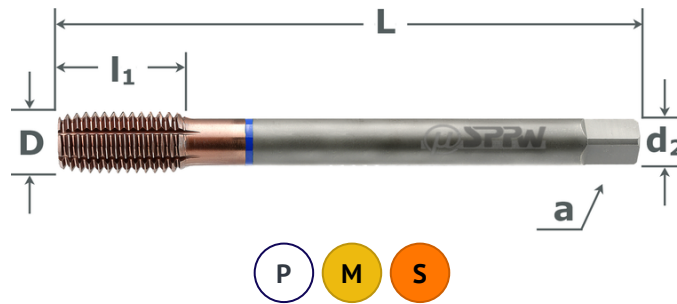

HSS PM	C Cut
DIN 371	Form C
DIN 374	Iso2 6HX
DIN 376	M MF

M/MF	Stg TPI	L	l1	$\emptyset d2$	$\emptyset a$	Art. No.	M/MF	Stg TPI	L	l1	$\emptyset d2$	$\emptyset a$	Art. No.
3	0,5	56	10	3,5	2,7	3604900300	10	1	90	18	10	8	3604901010
4	0,7	63	12	4,5	3,4	3604900400	12	1,75	110	22	9	7	3604901200
5	0,8	70	14	6	4,9	3604900500	12	1,5	100	22	9	7	3604901215
6	1	80	16	6	4,9	3604900600	14	2	110	25	11	9	3604901400
8	1,25	90	18	8	6,2	3604900800	14	1,5	100	22	11	9	3604901415
8	1	90	18	8	6,2	3604900810	16	2	110	28	12	9	3604901600
10	1,5	100	20	10	8	3604901000							

INFO

Leistungs-Gewindeformer aus Pulvermetall | High Performance Powder Metal Cold Forming Taps

Geformte Gewinde weisen einen nicht unterbrochenen Faserverlauf (B) auf, bei gleichzeitiger Kaltverfestigung des Werkstoffs. Hierdurch erhöht sich die Festigkeit im Vergleich zu herkömmlichen Gewinden erheblich. Zudem werden Winkelabweichungen vermieden, da der Werkstoff spielfrei verformt wird. Die Gewinde sind über die gesamte Länge toleranzhaltig.

Formed threads have an uninterrupted fiber pattern (B) with simultaneous work hardening of the material. This significantly increases the strength compared to conventional threads. In addition, angular variances are avoided, as the material is deformed without play. The threads are within tolerance over the entire length.

Vorteile:

1. Doppelte Schnittgeschwindigkeit ($vc \times 2$)
2. Geformte Gewinde haben höhere Festigkeit
3. Für Grund- und Durchgangslöcher einsetzbar
4. Spanlos, keine Spanabfuhr und Entsorgung
5. Stabileres Werkzeug durch günstige Werkzeugform

Voraussetzungen:

- Werkstoffe mit guter Kaltverformbarkeit
- Dehnungskoeffizient $> 10\%$
- Hochwertiges Kühlschmiermittel (graphithaltig)
- Vorbohrung größer, als beim Gewindeschneiden

Advantages:

1. doubling of cutting speed ($vc \times 2$).
2. formed threads have increased strength
3. can be used for blind and through holes
4. chipless, no problems with chip removal and disposal
5. more stable tool due to favorable tool shape

Requirements:

- Materials with good cold forming properties
- Elongation coefficient $> 10\%$
- High-quality lubricants (containing graphite)
- Predrilled hole must be larger than for tapping

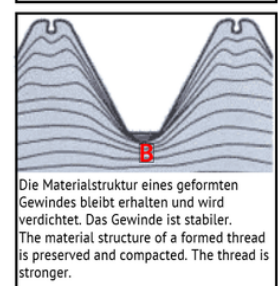
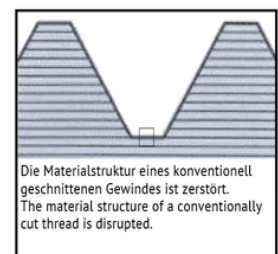

360 420

HP-Gewindebohrer Pulvermetall+C.Cut M/MF - Inox HP Powder Metal Taps+C.Cut M/MF - Inox



- Rostfreier Stahl und legierter Stahl
- Schälanschnitt für DL bis 2,5xØ
- Langer Anschnitt 3-5 Gang
- Flankenhinterschliff
- Bis M10 mit verstärktem Schaft
- Oberfläche C.Cut beschichtet

- Stainless steel and alloyed steel
- Spiral point for through holes 2,5xØ
- Long chamfer 3-5 threads
- Reduced torque due to back taper
- Up to M10 with reinforced shank
- With C.Cut coating

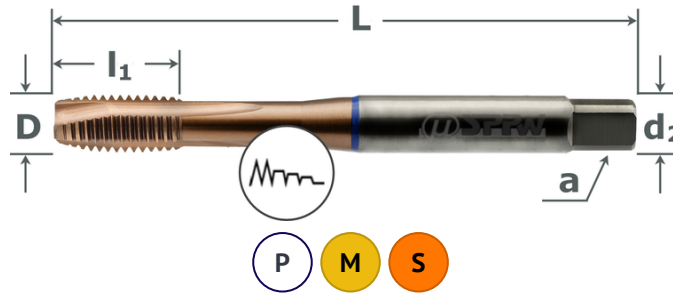

HSS PM	C Cut
DIN 371	Form B
DIN 374	Iso2 6H
DIN 376	M MF

M/MF	Stg TPI	L	l1	Ød2	Øa	Art. No.
3	0,5	56	10	3,5	2,7	3604200300
4	0,7	63	12	4,5	3,4	3604200400
5	0,8	70	14	6	4,9	3604200500
6	1	80	16	6	4,9	3604200600
8	1,25	90	18	8	6,2	3604200800
8	1	90	18	8	6,2	3604200810
10	1,5	100	20	10	8	3604201000

M/MF	Stg TPI	L	l1	Ød2	Øa	Art. No.
10	1	90	18	10	8	3604201010
12	1,75	110	22	9	7	3604201200
12	1,5	100	22	9	7	3604201215
14	2	110	25	11	9	3604201400
14	1,5	100	22	11	9	3604201415
16	2	110	28	12	9	3604201600

360 450

HP-Gewindebohrer Pulvermetall+C.Cut M/MF - Inox HP Powder Metal Taps+C.Cut M/MF Inox



- Rostfreier Stahl und legierter Stahl
- Gedrallt für Grundlöcher bis 2,5xØ
- Kurzer Anschnitt 2-3 Gang
- Flankenhinterschliff
- Bis M10 mit verstärktem Schaft
- Oberfläche C.Cut beschichtet

- Stainless steel and alloyed steel
- Spiral flutes for blind holes 2,5xØ
- Short chamfer 2-3 threads
- Reduced torque due to back taper
- Up to M10 with reinforced shank
- With C.Cut coating

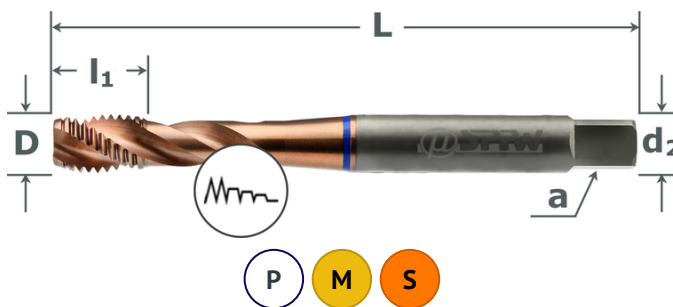

HSS PM	C Cut
DIN 371	Form C35
DIN 374	Iso2 6H
DIN 376	M MF

M/MF	Stg TPI	L	l1	Ød2	Øa	Art. No.
3	0,5	56	5	3,5	2,7	3604500300
4	0,7	63	7	4,5	3,4	3604500400
5	0,8	70	9	6	4,9	3604500500
6	1	80	10	6	4,9	3604500600
8	1,25	90	12	8	6,2	3604500800
8	1	90	12	8	6,2	3604500810
10	1,5	100	14	10	8	3604501000

M/MF	Stg TPI	L	l1	Ød2	Øa	Art. No.
10	1	90	14	10	8	3604501010
12	1,75	110	16	9	7	3604501200
12	1,5	100	14	9	7	3604501215
14	2	110	18	11	9	3604501400
14	1,5	100	18	11	9	3604501415
16	2	110	18	12	9	3604501600

M



- Aluminium-Legierungen
- Grund- und DL bis $2 \times \emptyset$
- Ohne Kühlnut für höhere Stabilität
- Bis M10 mit verstärktem Schaft
- Oberfläche A.Cut beschichtet
- Aluminum alloys
- Through and blind holes $2 \times \emptyset$
- Higher rigidity, without oil grooves
- Up to M10 with reinforced shank
- With A.Cut coating

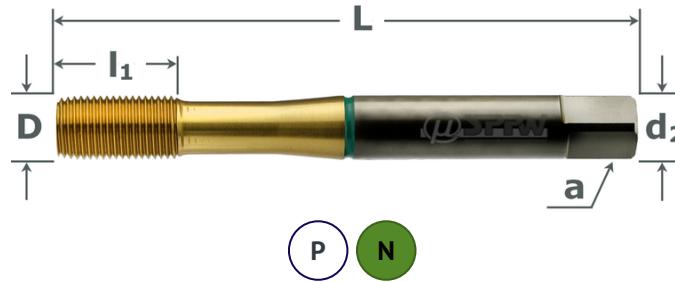

HSS PM	A Cut
DIN 371	Form C
DIN 374	Iso2 6HX
DIN 376	M MF

M/MF	Stg TPI	L	l1	$\emptyset d2$	$\emptyset a$	Art. No.
3	0,5	56	10	3,5	2,7	3601900300
4	0,7	63	12	4,5	3,4	3601900400
5	0,8	70	14	6	4,9	3601900500
6	1	80	16	6	4,9	3601900600
8	1,25	90	18	8	6,2	3601900800
8	1	90	18	8	6,2	3601900810
10	1,5	100	20	10	8	3601901000

M/MF	Stg TPI	L	l1	$\emptyset d2$	$\emptyset a$	Art. No.
10	1	90	18	10	8	3601901010
12	1,75	110	22	9	7	3601901200
12	1,5	100	22	9	7	3601901215
14	2	110	25	11	9	3601901400
14	1,5	100	22	11	9	3601901415
16	2	110	28	12	9	3601901600

INFO

Hochleistungs-Gewindeformer aus Pulvermetall | High Performance Powder Metal Cold Forming Taps

Geformte Gewinde weisen einen nicht unterbrochenen Faserverlauf (B) auf, bei gleichzeitiger Kaltverfestigung des Werkstoffs. Hierdurch erhöht sich die Festigkeit im Vergleich zu herkömmlichen Gewinden erheblich. Zudem werden Winkelabweichungen vermieden, da der Werkstoff spielfrei verformt wird. Die Gewinde sind über die gesamte Länge toleranzhaltig.

Formed threads have an uninterrupted fiber pattern (B) with simultaneous work hardening of the material. This significantly increases the strength compared to conventional threads. In addition, angular variances are avoided, as the material is deformed without play. The threads are within tolerance over the entire length.

Vorteile:

1. Doppelte Schnittgeschwindigkeit ($vc \times 2$)
2. Geformte Gewinde haben höhere Festigkeit
3. Für Grund- und Durchgangslöcher einsetzbar
4. Spanlos, keine Spanabfuhr und Entsorgung
5. Stabileres Werkzeug durch günstige Werkzeugform

Voraussetzungen:

- Werkstoffe mit guter Kaltverformbarkeit
- Dehnungskoeffizient $> 10\%$
- Hochwertiges Kühlschmiermittel (graphithaltig)
- Vorbohrung größer, als beim Gewindeschneiden

Advantages:

1. doubling of cutting speed ($vc \times 2$).
2. formed threads have increased strength
3. can be used for blind and through holes
4. chipless, no problems with chip removal and disposal
5. more stable tool due to favorable tool shape

Requirements:

- Materials with good cold forming properties
- Elongation coefficient $> 10\%$
- High-quality lubricants (containing graphite)
- Predrilled hole must be larger than for tapping

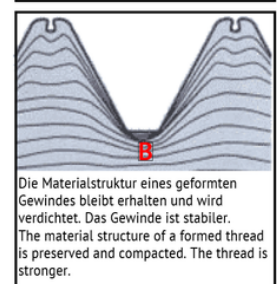
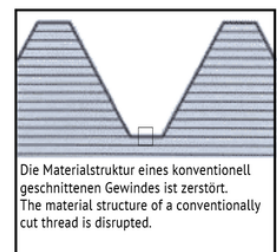

360 120

HP-Gewindebohrer Pulvermetall+A.Cut M/MF - Aluminium HP Powder Metal Taps+A.Cut M/MF - Aluminium



- Langspanende Werkstoffe
- Schälanschnitt für DL bis 2,5xØ
- Kurzer Anschnitt 2-3 Gang
- Ausgesetzte Zähne
- Bis M10 mit verstärktem Schaft
- Oberfläche A.Cut beschichtet
- Long chipping materials
- Spiral point for through holes 2,5xØ
- Short chamfer 2-3 threads
- Thread depth to
- Less torque due to interrupted threads
- Up to M10 with reinforced shank
- With A.Cut coating

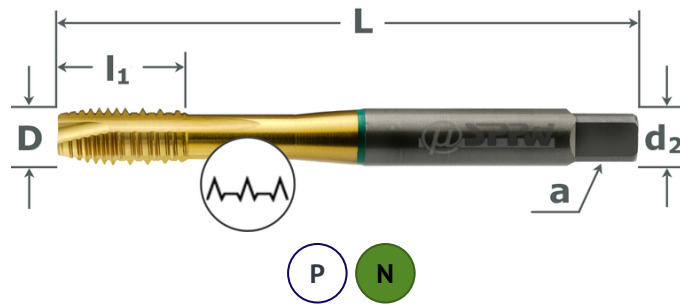

HSS PM	A Cut
DIN 371	Form B
DIN 374	Iso2 6H
DIN 376	M MF

M/MF	Stg TPI	L	l1	Ød2	Øa	Art. No.
3	0,5	56	10	3,5	2,7	3601200300
4	0,7	63	12	4,5	3,4	3601200400
5	0,8	70	14	6	4,9	3601200500
6	1	80	16	6	4,9	3601200600
8	1,25	90	18	8	6,2	3601200800
8	1	90	18	8	6,2	3601200810
10	1,5	100	20	10	8	3601201000

M/MF	Stg TPI	L	l1	Ød2	Øa	Art. No.
10	1	90	18	10	8	3601201010
12	1,75	110	22	9	7	3601201200
12	1,5	100	22	9	7	3601201215
14	2	110	28	11	9	3601201400
14	1,5	100	22	11	9	3601201415
16	2	110	28	12	9	3601201600

360 150

HP-Gewindebohrer Pulvermetall+A.Cut M/MF - Aluminium HP Powder Metal Taps+A.Cut M/MF - Aluminium



- Langspanende Werkstoffe
- Gedrallt für Grundlöcher bis 2,5xØ
- Kurzer Anschnitt 2-3 Gang
- Ausgesetzte Zähne
- Bis M10 mit verstärktem Schaft
- Oberfläche A.Cut beschichtet
- Long chipping materials
- Spiral flutes for blind holes 2,5xØ
- Short chamfer 2-3 threads
- Less torque due to interrupted threads
- Up to M10 with reinforced shank
- With A.Cut coating

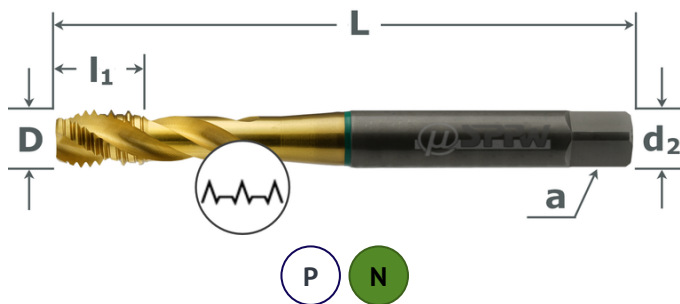

HSS PM	A Cut
DIN 371	Form C35
DIN 374	Iso2 6H
DIN 376	M MF

M/MF	Stg TPI	L	l1	Ød2	Øa	Art. No.
3	0,5	56	5	3,5	2,7	3601500300
4	0,7	63	7	4,5	3,4	3601500400
5	0,8	70	9	6	4,9	3601500500
6	1	80	10	6	4,9	3601500600
8	1,25	90	12	8	6,2	3601500800
8	1	90	12	8	6,2	3601500810
10	1,5	100	14	10	8	3601501000

M/MF	Stg TPI	L	l1	Ød2	Øa	Art. No.
10	1	90	14	10	8	3601501010
12	1,75	110	16	9	7	3601501200
12	1,5	100	14	9	7	3601501215
14	2	110	18	11	9	3601501400
14	1,5	100	18	11	9	3601501415
16	2	110	18	12	9	3601501600

M

360 310

HP-Gewindebohrer Pulvermetall+C.Cut M/MF - Guss HP Powder Metal Taps+C.Cut M/MF - Cast Iron



- Gusswerkstoffe
- Für Grund- und DL bis 2xØ
- Kurzer Anschnitt 2-3 Gang
- Bis M10 mit verstärktem Schaft
- Oberfläche C.Cut beschichtet

- Cast steels
- Spiral point for through holes 2xØ
- Short chamfer 2-3 threads
- Up to M10 with reinforced shank
- With C.Cut coating

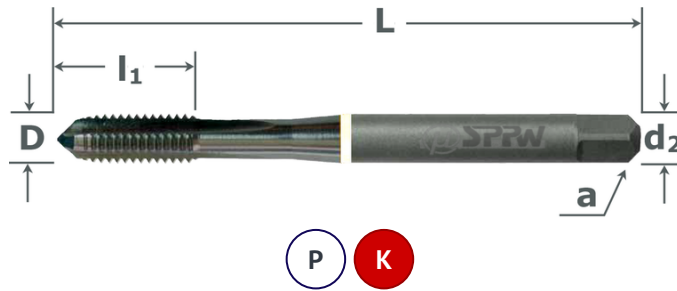

HSS PM	C Cut
DIN 371	Form C
DIN 374	Iso2 6H
DIN 376	M MF

M/MF	Stg TPI	L	l1	Ød2	Øa	Art. No.
3	0,5	56	10	3,5	2,7	3603100300
4	0,7	63	12	4,5	3,4	3603100400
5	0,8	70	14	6	4,9	3603100500
6	1	80	16	6	4,9	3603100600
8	1,25	90	18	8	6,2	3603100800
8	1	90	18	8	6,2	3603100810
10	1,5	100	20	10	8	3603101000

M/MF	Stg TPI	L	l1	Ød2	Øa	Art. No.
10	1	90	18	10	8	3603101010
12	1,75	110	22	9	7	3603101200
12	1,5	100	22	9	7	3603101215
14	2	110	25	11	9	3603101400
14	1,5	100	22	11	9	3603101415
16	2	110	28	12	9	3603101600

360 210

HP-Gewindebohrer HSS-E M/MF - Kupfer HSS-E Taps M/MF - Copper



- Kupferlegierungen
- Für Grund- und DL bis 2xØ
- Kurzer Anschnitt 2-3 Gang
- Bis M10 mit verstärktem Schaft
- Oberfläche blank

- Copper-alloys
- For through holes and blind holes 2xØ
- Short chamfer 2-3 threads
- Up to M10 with reinforced shank
- Bright finish

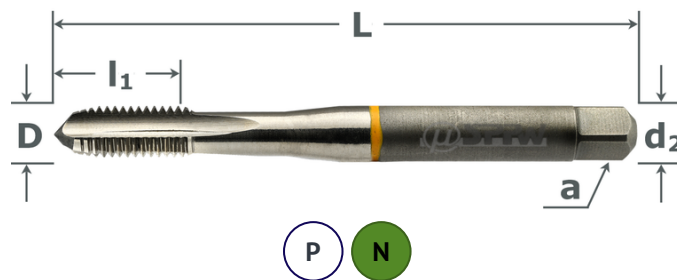

HSS E05	blank
DIN 371	Form C
DIN 374	Iso2 6H
DIN 376	M MF

M/MF	Stg TPI	L	l1	Ød2	Øa	Art. No.
3	0,5	56	10	3,5	2,7	3602100300
4	0,7	63	12	4,5	3,4	3602100400
5	0,8	70	14	6	4,9	3602100500
6	1	80	16	6	4,9	3602100600
8	1,25	90	18	8	6,2	3602100800
8	1	90	18	8	6,2	3602100810
10	1,5	100	20	10	8	3602101000

M/MF	Stg TPI	L	l1	Ød2	Øa	Art. No.
10	1	90	18	10	8	3602101010
12	1,75	110	22	9	7	3602101200
12	1,5	100	22	9	7	3602101215
14	2	110	25	11	9	3602101400
14	1,5	100	22	11	9	3602101415
16	2	110	28	12	9	3602101600

360 510**HP-Gewindebohrer Pulvermetall+C.Cut M/MF - 52HRC**
HP Powder Metal Taps+C.Cut M/MF - 52HRC

- Gehärtete Stähle bis 52 HRC
- Für Grund- und DL bis 1,5xØ Tiefe
- Langer Anschnitt 3,5-5 Gang
- Bis M10 mit verstärktem Schaft
- Oberfläche C.Cut beschichtet
- Lieferzeit ca. 5 Arbeitstage
- Hardened steels up to 52 HRC
- For through and blind holes 1,5xØ
- Long chamfer 3,5-5 threads
- Up to M10 with reinforced shank
- With C.Cut coating
- Delivery time approx. 5 working days



HSS PM	X Cut
Form D	Iso2 6HX
M MF	52 HRC

M/MF	Stg TPI	L	l1	Ød2	Øa	Art. No.
3	0,5	56	10	3,5	2,7	3605100300
4	0,7	63	12	4,5	3,4	3605100400
5	0,8	70	14	6	4,9	3605100500
6	1	80	16	6	4,9	3605100600
8	1,25	90	17	8	6,2	3605100800
8	1	90	17	8	6,2	3605100810
10	1,5	100	20	10	8	3605101000

M/MF	Stg TPI	L	l1	Ød2	Øa	Art. No.
10	1	90	17	10	8	3605101010
12	1,75	110	24	12	9	3605101200
12	1	100	20	11	9	3605101210
12	1,5	100	20	12	9	3605101215
14	2	110	26	11	9	3605101400
16	2	110	26	12	9	3605101600

360 721**Gewindebohrer Pulvermetall+C.Cut M/MF - Titan**
HP Powder Metal Taps+C.Cut M/MF - Titanium

- Titan-Legierungen bis 900 N/mm²
- Schälanschnitt für DL bis 1,5xØ
- Langer Anschnitt 4-5 Gang
- Bis M8 mit verstärktem Schaft
- Oberfläche C.Cut beschichtet
- Lieferzeit ca. 5 Arbeitstage
- Titanium-alloys up to 900 N/mm²
- Spiral point for through holes 1,5xØ
- Long chamfer 4-5 threads
- Up to M8 reinforced shank
- With C.Cut coating
- Delivery time approx. 5 working days



HSS PM	C Cut
Form B	Iso2 6HX
M MF	Titan

M/MF	Stg TPI	L	l1	Ød2	Øa	Art. No.
3	0,5	56	10	3,5	2,7	3607210300
4	0,7	63	12	4,5	3,4	3607210400
5	0,8	70	14	6	4,9	3607210500
6	1	80	16	6	4,9	3607210600
6	0,5	80	11	6	6,2	3607210605
6	0,75	80	11	6	4,9	3607210607
8	1,25	100	17	8	8	3607210800

M/MF	Stg TPI	L	l1	Ød2	Øa	Art. No.
8	0,75	80	14	8	7	3607210807
8	1	90	14	8	6,2	3607210810
10	1,5	100	20	10	9	3607211000
10	1	90	16	10	8	3607211010
12	1,75	110	24	9	7	3607211200
16	2	110	26	12	9	3607211600

M

360 125

Gewindebohrer HSS-E+X.Cut M - Aluminium HSS-E Taps+X.Cut M - Aluminium



- Langspanende Stähle und NE-Metalle
- Schälanschnitt für DL bis 2,5xØ
- Ausgesetzte Zähne
- Bis M10 mit verstärktem Schaft
- Oberfläche X.Cut beschichtet
- Long chipping Steels and NF-metals
- Spiral point for through holes 2,5xØ
- Less torque due to interrupted threads
- Up to M10 with reinforced shank
- With X.Cut coating

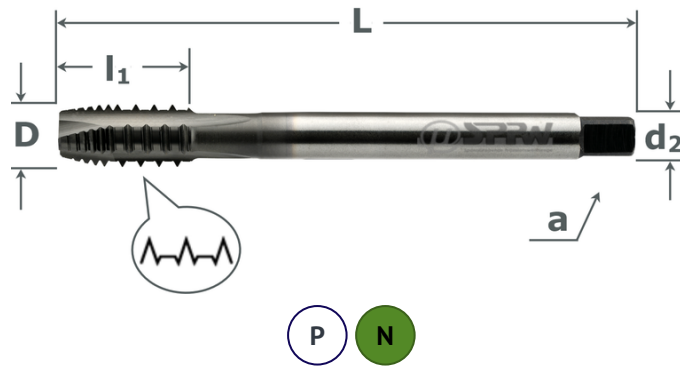

HSS E05	X Cut
DIN 371	Form B
Iso2 6H	DIN 376
M	AL

M	Stg TPI	L	l1	Ød2	Øa	Art. No.
3	0,5	56	10	3,5	2,7	3601250300
4	0,7	63	12	4,5	3,4	3601250400
5	0,8	70	14	6	4,9	3601250500
6	1	80	16	6	4,9	3601250600
8	1,25	90	18	8	6,2	3601250800

M	Stg TPI	L	l1	Ød2	Øa	Art. No.
10	1,5	100	20	10	8	3601251000
12	1,75	110	24	9	7	3601251200
14	2	110	25	11	9	3601251400
16	2	110	28	12	9	3601251600

360 165

Gewindebohrer HSS-E+X.Cut M - Aluminium HSS-E Taps+X.Cut M - Aluminium



- Langspanende Werkstoffe
- Gedrallt für Grundlöcher bis 2,5xØ
- Kurzer Anschnitt 2-3 Gang
- Bis M10 mit verstärktem Schaft
- Oberfläche X.Cut beschichtet
- Long chipping materials
- Spiral flutes for blind holes 2,5xØ
- Short chamfer 2-3 threads
- Up to M10 with reinforced shank
- With X.Cut coating



HSS E05	X Cut
DIN 371	Form C35
Iso2 6H	DIN 376
M	AL

M	Stg TPI	L	l1	Ød2	Øa	Art. No.
3	0,5	56	7	3,5	2,7	3601650300
4	0,7	63	8,5	4,5	3,4	3601650400
5	0,8	70	10	6	4,9	3601650500
6	1	80	12	6	4,9	3601650600
8	1,25	90	15	8	6,2	3601650800
10	1,5	100	17,5	10	8	3601651000

M	Stg TPI	L	l1	Ød2	Øa	Art. No.
12	1,75	110	18	9	7	3601651200
14	2	110	20,5	11	9	3601651400
16	2	110	20,5	12	9	3601651600
18	2,5	125	25,5	14	11	3601651800
20	2,5	140	29,5	16	12	3601652000

360 525**HP-Gewindebohrer HSS-E+X.Cut M - Inox**
HSS-E Taps+X.Cut M - Inox

- Langspanender rostfreier Stahl
- Schälschnitt für DL bis 2,5xØ Tiefe
- Langer Anschnitt 3-5 Gang
- Bis M10 mit verstärktem Schaft
- Oberfläche X.Cut beschichtet

- Long chipping stainless steel
- Spiral point for through holes 2,5xØ
- Long chamfer 3-5 threads
- Up to M10 with reinforced shank
- With X.Cut coating

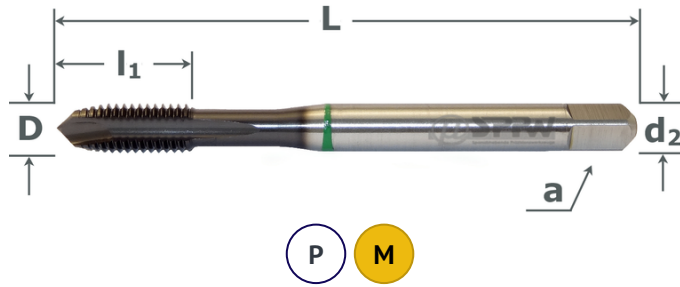

HSS E05	X Cut
DIN 371	Form B
Iso2 6H	DIN 376
M	

M	Stg TPI	L	l1	Ød2	Øa	Art. No.
3	0,5	56	10	3,5	2,7	3605250300
3,5	0,6	56	11	4	3	3605250350
4	0,7	63	12	4,5	3,4	3605250400
5	0,8	70	14	6	4,9	3605250500
6	1	80	16	6	4,9	3605250600
8	1,25	90	18	8	6,2	3605250800

M	Stg TPI	L	l1	Ød2	Øa	Art. No.
10	1,5	100	20	10	8	3605251000
12	1,75	110	24	9	7	3605251200
14	2	110	25	11	9	3605251400
16	2	110	28	12	9	3605251600
18	2,5	125	32	14	11	3605251800
20	2,5	140	32	16	12	3605252000

360 555**Gewindebohrer HSS-E+X.Cut M - Inox**
HP HSS-E Taps+X.Cut M - Inox

- Langspanender rostfreier Stahl
- Gedrallt für Grundlöcher bis 2,5xØ
- Kurzer Anschnitt 2-3 Gang
- Bis M10 mit verstärktem Schaft
- Oberfläche X.Cut beschichtet

- Long chipping stainless steel
- Spiral flutes for blind holes 2,5xØ
- Short chamfer 2-3 threads
- Up to M10 with reinforced shank
- With X.Cut coating



HSS E05	X Cut
DIN 371	Form C40
Iso2 6H	DIN 376
M	

M	Stg TPI	L	l1	Ød2	Øa	Art. No.
3	0,5	56	10	3,5	2,7	3605550300
4	0,7	63	12	4,5	3,4	3605550400
5	0,8	70	14	6	4,9	3605550500
6	1	80	16	6	4,9	3605550600
8	1,25	90	18	8	6,2	3605550800
10	1,5	100	20	10	8	3605551000

M	Stg TPI	L	l1	Ød2	Øa	Art. No.
12	1,75	110	24	9	7	3605551200
14	2	110	25	11	9	3605551400
16	2	110	28	12	9	3605551600
18	2,5	125	32	14	11	3605551800
20	2,5	140	32	16	12	3605552000

M

306 100

Gewindebohrer HSS-E M - Form B Lang HSS-E Taps M - Form B Long Series



- Stähle bis 800 N/mm²
- Schälanschnitt für DL bis 2xØ
- Langer Anschnitt 3-5 Gang
- Lange und stabile Ausführung
- Überlaufschaft für Zugangsprobleme
- Oberfläche blank

- Steels up to 800 N/mm²
- Spiral point for THD up to 2xØ depth
- Long chamfer 3-5 threads
- Long and extra rigid reinforced shank
- Reduced shank for access problems
- Bright finish

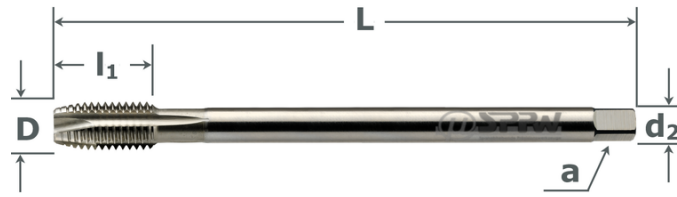

HSS E05	blank
Form B	Iso2 6H
ZYL	L lang
M	

M/MF	Stg TPI	L	l1	Ød2	Øa	Art. No.
3	0,5	100	11	3,5	2,7	3061000300
3	0,5	90	19	2,1	1,6	3061000300UE
4	0,7	100	13	4,5	3,4	3061000400
4	0,7	100	20	2,9	2,3	3061000400UE
5	0,8	120	16	6	4,9	3061000500
5	0,8	110	25	3,7	3	3061000500UE
6	1	120	19	6	4,9	3061000600

M/MF	Stg TPI	L	l1	Ød2	Øa	Art. No.
6	1	120	27	4,5	3,5	3061000600UE
8	1,25	150	22	8	6,2	3061000800
8	1,25	135	32	6,2	5	3061000800UE
10	1,5	150	24	10	8	3061001000
10	1,5	150	38	7,6	6	3061001000UE
12	1,75	150	29	12	9	3061001200
12	1,75	165	43	9	7	3061001200UE

306 300

Gewindebohrer HSS-E M - Form C Lang HSS-E Taps M - Form C Long Series



- Stähle bis 800 N/mm²
- Gedrallt für Grundlöcher bis 2xØ
- Langer Anschnitt 2-3 Gang
- Oberfläche blank

- Steels up to 800 N/mm²
- Spiral flutes for blind holes 2xØ
- Long chamfer 2-3 threads
- Bright finish

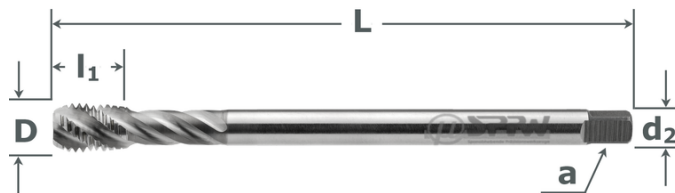

HSS E05	blank
Form C35	Iso2 6H
ZYL	L lang
M	

M/MF	Stg TPI	L	l1	Ød2	Øa	Art. No.
3	0,5	100	6	3,5	2,7	3063000300
4	0,7	100	7	4,5	3,4	3063000400
5	0,8	120	8	6	4,9	3063000500
6	1	120	10	6	4,9	3063000600

M/MF	Stg TPI	L	l1	Ød2	Øa	Art. No.
8	1,25	150	14	8	6,2	3063000800
10	1,5	150	16	10	8	3063001000
12	1,75	150	18	12	9	3063001200

M

334 300**Gewindebohrer HSS-E M - Form B Toleranz 6G**
HSS-E Taps M - Form B Tolerance 6G

- Allgemeine Anwendung
- Schälanschnitt für DL bis $2x\varnothing$
- Langer Anschnitt 3-5 Gang 8°
- Toleranz 6G
- Bis M10 mit verstärktem Schaft
- Oberfläche blank
- General use
- Spiral point for through holes $2x\varnothing$
- Long chamfer 3-5 threads 8°
- Tolerance 6G
- Up to M10 with reinforced shank
- Bright finish



HSS E05	blank
DIN 371	Form B
DIN 376	Iso2 6G
ZYL	M

M	Stg TPI	L	l1	Ød2	Øa	Art. No.
2	0,4	45	7	2,8	2,1	3343000200
2,5	0,45	50	9	2,8	2,1	3343000250
3	0,5	56	10	3,5	2,7	3343000300
4	0,7	63	12	4,5	3,4	3343000400
5	0,8	70	14	6	4,9	3343000500
6	1	80	16	6	4,9	3343000600

M	Stg TPI	L	l1	Ød2	Øa	Art. No.
8	1,25	90	18	8	6,2	3343000800
10	1,5	100	20	10	8	3343001000
12	1,75	110	24	9	7	3343001200
14	2	110	25	11	9	3343001400
16	2	110	28	12	9	3343001600

313 400**Gewindebohrer HSS-E G - Form C**
HSS-E Taps G - Form C

- Stähle bis 800 N/mm^2
- Für Grund- und DL bis $1,5x\varnothing$
- Kurzer Anschnitt 2-3 Gang
- Flankenwinkel 55° (Britisch)
- Ab G 7/8" aus HSS
- Oberfläche blank
- Steels up to 800 N/mm^2
- For blind and through holes $1,5x\varnothing$
- Short chamfer 2-3 threads
- Thread angle 55° (British)
- G 7/8" in HSS
- Bright finish



HSS E05	blank
DIN 5156	Form C
ZYL	G

G	Stg TPI	L	l1	Ød2	Øa	Art. No.
1/2"	14	125	25	16	12	3134000012
1/4"	19	100	22	11	9	3134000014
1/8"	28	90	20	7	5,5	3134000018
3/4"	14	140	28	20	16	3134000034
3/8"	19	100	22	12	9	3134000038
5/8"	14	125	25	18	14,5	3134000058
7/8"	14	150	28	22	18	3134000078

G	Stg TPI	L	l1	Ød2	Øa	Art. No.
1"	11	160	30	25	20	3134000100
1"1/2	11	190	32	36	29	3134000112
1"1/4	11	170	30	32	24	3134000114
1"1/8	11	170	30	28	22	3134000118
1"3/4	11	190	32	40	32	3134000134
1"3/8	11	180	32	36	29	3134000138
2"	11	220	40	45	35	3134000200

M

312 800**Gewindebohrer HSS-E UNC/UNF - Form C**
HSS-E Taps UNC/UNF - Form C

- Aluminium und Stähle bis 800 N/mm²
- Für Grund- und DL bis 1,5xØ
- Kurzer Anschnitt 2-3 Gang
- Bis 3/8" mit verstärktem Schaft
- Oberfläche blank

- Aluminum and steels to 800 N/mm²
- For blind and through holes 1,5xØ
- Short Chamfer 2-3 threads
- Up to 3/8" with reinforced shank
- Bright finish

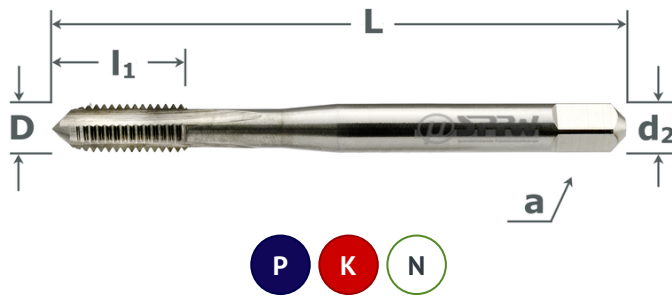

HSS E05	blank
DIN 371	Form C
ZYL	UNC UNF

312800 - UNC

UNC	Stg TPI	L	l1	Ød2	Øa	Art. No.
1/4"	20	80	16	7	5,5	3128000014
3/8"	16	90	18	9	7	3128000038
5/16"	18	90	18	8	6,2	3128000516

UNC	Stg TPI	L	l1	Ød2	Øa	Art. No.
No 6	32	56	11	4	3	3128000600
No 8	32	63	12	4,5	3,4	3128000800

312900 - UNF

UNF	Stg TPI	L	l1	Ød2	Øa	Art. No.
1/4"	28	80	16	7	5,5	3129000014
3/8"	24	100	18	9	7	3129000038

UNF	Stg TPI	L	l1	Ød2	Øa	Art. No.
No 10	32	70	14	6	4,9	3129001000

324 500**Gewindebohrer HSS NPT - Konisch 1:16**
HSS Conical Taps NPT - 1:16

- Stähle bis 800 N/mm²
- Für Grund- und Durchgangslöcher
- Kurzer Anschnitt 2-3 Gang 15°
- Kegelige Gewinde mit Steigung 1:16
- Flankenwinkel 60° (NPT)
- Oberfläche blank

- Steels up to 800 N/mm²
- For blind holes and through holes
- Short chamfer 2-3 threads 15°
- Conical flutes for tapered threads 1:16
- Thread angle 60° (NPT)
- Bright finish

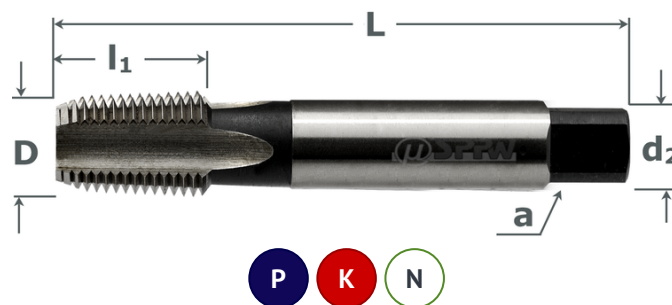

HSS	blank
Form C	ZYL
NPT	

NPT	Stg TPI	L	l1	Ød2	Øa	Art. No.
1/2"	14	80	31	16	12	3245000012
1/4"	18	70	25	11	9	3245000014
1/8"	27	65	19	7	5,5	3245000018
3/4"	14	100	33	20	16	3245000034
3/8"	18	75	26	12	9	3245000038

NPT	Stg TPI	L	l1	Ød2	Øa	Art. No.
1"	11,5	110	38	25	20	3245000100
1"1/2	11,5	140	42	36	29	3245000112
1"1/4	11,5	125	41	32	24	3245000114
1/16"	27	65	19	7	5,5	3245000116
2"	11,5	160	44	36	29	3245000200

324 600

Gewindebohrer HSS BSPT - Konisch 1:16
HSS Conical Taps BSPT - 1:16



- Stähle bis 800 N/mm²
- Für Grund- und DL
- Kurzer Abschnitt 2-3 Gang
- Kegelige Gewinde mit Steigung 1:16
- Flankenwinkel 55°
- Oberfläche blank

- Steels up to 800 N/mm²
- For blind holes and through holes
- Short chamfer 2-3 threads
- For tapered threads 1:16
- Blind holes and through holes
- Thread angle 55°
- Bright finish

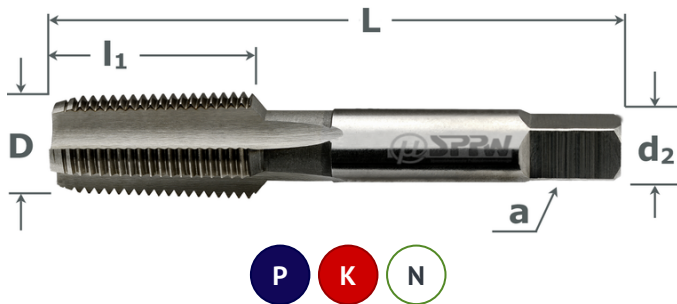

HSS	blank
Form C	ZYL
BSPT	

BSPT	Stg TPI	L	l1	Ød2	Øa	Art. No.
1/2"	14	80	31	16	12	3246000012
1/4"	19	70	25	11	9	3246000014
1/8"	28	65	19	7	5,5	3246000018

BSPT	Stg TPI	L	l1	Ød2	Øa	Art. No.
3/4"	14	100	33	20	16	3246000034
3/8"	19	75	26	12	9	3246000038
1"	11	110	38	25	20	3246000100

311 602

Handgewindebohrer-Satz HSS+Nit.X M - 3er
HSS Hand Taps +Nit.X M - Set of 3 taps



- Inox und Stähle bis 950 N/mm²
- Gerade genutet für Grund- und DL
- Satz zu 3 Stück
- Vor (A), Mittel (D), Fertig (C)
- Oberfläche Nit.X vaporisiert

- Stainless and steels to 950 N/mm²
- Straight flutes for BHD and THD
- Set of 3 taps
- Taper (A), middle (D), finishing (C)
- Surface wit Nit.X treatment

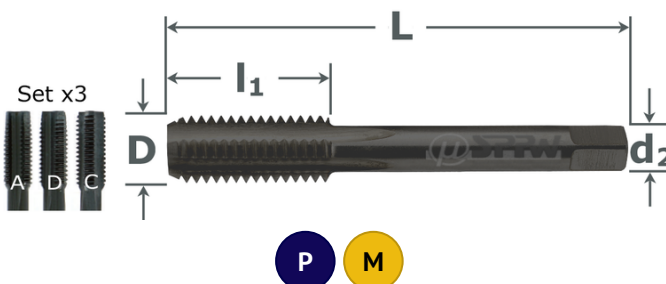

HSS	Nit X
DIN 352	Form A-D-C
ZYL	Hand
M	

M	Stg	L	l1	Ød2	Art. No.
2,0	0,4	36	11	2,8	3116020200
2,5	0,45	40	11	2,8	3116020250
3,0	0,5	40	11	3,5	3116020300
3,5	0,6	45	12	4	3116020350
4,0	0,7	45	13	4,5	3116020400
5,0	0,8	50	15	6	3116020500
6	1	50	16	6	3116020600
7	1	50	19	6	3116020700
8	1,25	56	22	6	3116020800
9	1,25	63	22	7	3116020900
10	1,5	70	24	7	3116021000

M	Stg	L	l1	Ød2	Art. No.
11	1,5	70	24	8	3116021100
12	1,75	75	29	9	3116021200
14	2	80	29	11	3116021400
16	2	80	31	12	3116021600
18	2,5	95	39	14	3116021800
20	2,5	95	39	16	3116022000
22	2,5	100	40	18	3116022200
24	3	110	45	18	3116022400
27	3	110	50	20	3116022700
30	3,5	125	56	22	3116023000



300 502**Schneideisen HSS-E+Nit.X M - Form B**
HSS-E Dies +Nit.X Metric Form B

- Für metrische Gewinde
- Mit Schälanschnitt
- Leichter Schnitt, gute Spanabfuhr
- Geschlossene Form, Toleranz 6g
- Oberfläche Nit.X vaporisiert
- For metric threads
- With gun nose lead
- Easy first cut, clean chip evacuation
- Solid form, tolerance 6g
- Surface with Nit.X treatment

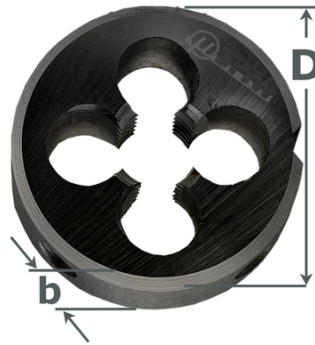

HSS E05	Nit X
EN 22568	Form B
ISO 6g	M



M	Stg	ØD	b Breite	Art. No.
2	0,4	16	5	3005020200
2,5	0,45	16	5	3005020250
3	0,5	20	5	3005020300
4	0,7	20	5	3005020400
5	0,8	20	7	3005020500
6	1	20	7	3005020600
8	1,25	25	9	3005020800
10	1,5	30	11	3005021000
12	1,75	38	14	3005021200

M	Stg	ØD	b Breite	Art. No.
14	2	38	14	3005021400
16	2	45	18	3005021600
18	2,5	45	18	3005021800
20	2,5	45	18	3005022000
22	2,5	55	22	3005022200
24	3	55	22	3005022400
27	3	65	25	3005022700
30	3,5	65	25	3005023000

M**— INFO —**

Weitere Handgewindebohrer und Schneideisen auf www.sppw.de
For more hand taps and dies visit www.sppw.de





**[DE] Technische
Informationen**
**[EN] Technical
Information**

passion for precision
[Leidenschaft für Präzision]



Schneidstoffe

Cutting Materials

VHM	= Vollhartmetall Vollhartmetalle sind Sinterwerkstoffe und bestehen meistens aus 88 - 94 % Wolframcarbid (WC) und 6 - 12 % Cobalt (als Binder) und ggf. anderen Karbiden wie TiC oder TaC. Kennzeichnend sind hohe Härte, Verschleißfestigkeit und Warmfestigkeit. Je nach Anwendung finden verschiedene Hartmetallsorten Anwendung. Die verwendeten Sorten fallen dabei in den Bereich K10 - K44 UF. Hartmetalle sind weniger zäh als Schnellarbeitsstähle (HSS), erlauben aber höhere Schnitttemperaturen und somit höhere Schnittgeschwindigkeiten. Hartmetalle haben eine Härte 1400 - 2400 HV und eine mittlere Biegefestigkeit von 900 - 2000 N/mm ² . Hierdurch sind sie aber auch deutlich spröder, also empfindlich gegen Schocks und gegen plötzliche Temperaturwechsel.
HSS	= High Speed Steel (Schnellarbeitsstahl) Die gängigste Variante ist S-6-5-2 (DIN 1.3343). HSS zeichnet sich durch eine breite Verfügbarkeit und Vielseitigkeit in den Anwendungen aus. Im Vergleich zu Hartmetall weist HSS eine geringere Härte (62 - 64 HRC), aber dafür eine höhere Biegebruchfestigkeit auf. Die Schnittgeschwindigkeiten sind, verglichen mit VHM, deutlich geringer. HSS eignet sich i.d.R. zur Bearbeitung von Werkstoffen mit Zugfestigkeiten bis 900 N/mm ² .
HSS E	= High Speed Steel (Schnellarbeitsstahl) Schnellarbeitsstahl mit einem Kobaltgehalt von mind. 4,5 % oder Vanadium von mindestens 2,6 %. HSS-E erlaubt höhere Bearbeitungstemperaturen als HSS, erhöhte Schnittgeschwindigkeiten sind möglich. Die Härte von HSS-E liegt zwischen 64 HRC und 66 HRC. Mit HSS-E ist die Bearbeitung von zäheren oder spröden Werkstoffen möglich.
HSS E05	= High Speed Steel (Schnellarbeitsstahl) Schnellarbeitsstahl mit einem Kobaltgehalt von mind. 4,5 % (S-6-5-2-5 DIN 1.3243). Hierdurch kann in höheren Temperaturbereichen gearbeitet werden, was erhöhte Schnittgeschwindigkeiten zu HSS erlaubt. Die Härte von HSS-E05 liegt zwischen 64 HRC und 66 HRC.
HSS E08	= High Speed Steel (Schnellarbeitsstahl) Schnellarbeitsstahl mit einem Kobaltgehalt von ca. 8% (S-2-9-1-8 DIN 1.3247). HSS-E08 ist die Schnellarbeitsstahlvariante mit der höchsten Warmfestigkeit. Es findet daher bevorzugt bei der Bearbeitung von Werkstoffen mit schlechter Wärmeleitung Anwendung. Die Härte von HSS-E08 liegt zwischen 65 HRC und 67 HRC.
PM	= Pulvermetall Hier handelt es sich um gesinterte Schnellstähle. Sie vereinen die Vorteile von HSS und VHM. Erhöhte Bruchsicherheit und Ermüdungsfestigkeit durch gleichmäßig verteilte Karbide, keine metallurgischen Defekte. Karbidvolumen und Härte steigern die Widerstandsfähigkeit gegen abrasiven und adhäsiven Verschleiß. PM hat ein deutlich verbessertes Verschleißverhalten im Vergleich mit HSS. Verwendet werden verschiedene PM-Sorten mit unterschiedlichen Vanadium- und Kobalt-Anteilen. Die Härte von PM liegt zwischen 64 HRC und 67 HRC.
HM-Platte	= mit Hartmetall bestückt Hierbei werden eine oder mehrere Schneidplatten aus Hartmetall auf einen Grundkörper aus Schnellstahl gelötet. Dies kombiniert Biegebruchfestigkeit von HSS mit Verschleißfestigkeit von VHM. Verwendet wird ein Hochtemperaturlot, das bis 800 °C stabil bleibt.

Wichtigste Herstellungstoleranzen nach DIN 7160/7161

Main manufacturing tolerances

Werte in µm - 0,001 mm

Passung	Nennmaße (Innenmaße) Ø in mm					
	1,0 3,0	3,1 6,0	6,1 10,0	10,1 18,0	18,1 30,0	30,1 50,0
d 9	- 20 - 45	- 30 - 60	- 40 - 76	- 50 - 93	- 65 - 117	- 80 - 142
d 11	- 20 - 80	- 30 - 105	- 40 - 130	- 50 - 160	- 65 - 195	- 80 - 240
e 8	- 20 - 28	- 20 - 38	- 25 - 140	- 32 - 59	- 40 - 73	- 50 - 89
f 8	- 6 - 20	- 10 - 28	- 13 - 35	- 16 - 43	- 20 - 53	- 25 - 64
f 9	- 60 - 31	- 10 - 28	- 13 - 49	- 19 - 59	- 20 - 72	- 25 - 87
h 6	0 - 6	0 - 8	0 - 9	0 - 11	0 - 13	0 - 16
h 7	0 - 10	0 - 12	0 - 15	0 - 18	0 - 21	0 - 25
h 8	0 - 14	0 - 18	0 - 22	0 - 27	0 - 33	0 - 39
h 9	0 - 25	0 - 30	0 - 36	0 - 43	0 - 52	0 - 62
h 10	0 - 40	0 - 48	0 - 58	0 - 70	0 - 84	0 - 100

Passung	Nennmaße (Innenmaße) Ø in mm					
	1,0 3,0	3,1 6,0	6,1 10,0	10,1 18,0	18,1 30,0	30,1 50,0
h 11	0 - 60	0 - 75	0 - 90	0 - 110	0 - 130	0 - 160
h 12	0 - 100	0 - 120	0 - 150	0 - 180	0 - 210	0 - 200
js 11	+ 30 - 30	+ 38 - 38	+ 45 - 45	+ 55 - 55	+ 65 - 65	+ 80 - 80
js 12	+ 50 - 50	+ 60 - 60	+ 75 - 75	+ 90 - 90	+ 105 - 105	+ 125 - 125
js 14	+ 125 - 125	+ 150 - 150	+ 180 - 180	+ 215 - 215	+ 260 - 260	+ 310 - 310
js 16	+ 300 - 300	+ 375 - 375	+ 450 - 450	+ 550 - 550	+ 650 - 650	+ 800 - 800
k 10	+ 40 0	+ 48 0	+ 58 0	+ 70 0	+ 84 0	+ 100 0
k 11	+ 60 0	+ 75 0	+ 90 0	+ 110 0	+ 130 0	+ 160 0
k 12	+ 90 0	+ 120 0	+ 150 0	+ 180 0	+ 210 0	+ 250 0
k 16	+600 0	+ 750 0	+ 900 0	+ 1100 0	+ 1300 0	+ 1600 0

Beschichtungen und Behandlungen

Coatings and Surface Treatments

blank Unbeschichtet.

poliert
polished Unbeschichtet mit polierten Spannuten und Schneiden für extrem scharfe Schneidkanten und beste Spanabfuhr.

Steam Die Oberfläche des Werkzeuges ist vaporisiert (dampfangelassen). Zur Verminderung von Kaltaufschweißungen und Aufbauschnneiden. Gute Haftung von Kühl- und Schmierstoffen.

A.Cut

Schichttyp	TiN-Basis (Titan-Nitrid)
Farbe	gelb/gold
Schichtdicke	2 - 4 µm
Härte	2.300 HV

Universell einsetzbare Beschichtung mit guter chemischer und thermischer Stabilität. Führt zur allgemeinen Verbesserung der Werkzeugleistung.



Alu.Cut

Schichttyp	TiB ² (Titan-Borid)
Farbe	silber
Schichtdicke	2 µm
Härte	4.000 HV

Hochleistungsschicht für Aluminium und Aluminium-Legierungen. Extrem glatte Oberfläche und hohe Härte. Vermeidung von Aluminium-Aufschweißungen.



C.Cut

Schichttyp	TiCN (Titan-Carbon-Nitrid)
Schichtfarbe	blau/violett
Schichtdicke	3 µm
Härte	3.000 HV

Universell einsetzbare Beschichtung mit hoher Zähigkeit und geringem Reibwert. Verwendung hauptsächlich beim Gewindebohren und -formen. Allgemeine Verbesserung der Werkzeugleistung.



C.Cut

Schichttyp	TiCN-Basis (Titan-Carbon-Nitrid)
Schichtfarbe	kupfer
Schichtdicke	3 µm
Härte	3.200 HV

TiCN-Beschichtung mit besonders glatter Oberflächen. Sehr niedriger Reibwert beugt Kaltaufschweißungen vor. Verwendung hauptsächlich beim Gewindebohren und Gewindeformen in Inox.



X.Cut

Schichttyp	TiAlN (Titan-Aluminium-Nitrid)
Schichtfarbe	blau/anthrazit
Schichtdicke	3 µm
Härte	3.300 HV

Optimierte Hochleistungsbeschichtung. Sehr gute Oxidationsbeständigkeit. Geeignet für hohe thermische Schneidstoffbelastung. Ermöglicht eine Erhöhung der Schnittwerte.



X₂.Cut

Schichttyp	AlCrN-Basis (Aluminium-Chrom-Nitrid)
Schichtfarbe	kupfer
Schichtdicke	
Härte	3.000 HV

Speziell für die Bohrbearbeitung optimierte Schicht. Mit erhöhter Abrasionsbeständigkeit und verbesserter Schichthaftung sowie geringer Adhäsionsneigung durch eine besonders glatte Oberfläche.



X₅.Cut

Schichttyp	TiAlN-Basis (Titan-Aluminium-Nitrid)
Schichtfarbe	kupfer
Schichtdicke	3 µm
Härte	3.500 HV

Optimierte Hochleistungsbeschichtung für Bohr- und Senkwerkzeuge aus HSS. Einsatz bei harten und abrasiven Legierungen. Deutliche Verbesserung der Werkzeugleistung.



X₆.Cut

Schichttyp	TiAlCN (Titan-Aluminium-Carbon-Nitrid)
Schichtfarbe	kupfer
Schichtdicke	3 µm
Härte	3.800 HV

Schicht mit nanostrukturiertem kristallinem Aufbau. Sehr hohe thermische Beständigkeit, verbunden mit besonders glatter Schichtoberfläche. Sehr gute Oberflächen am Werkstück.



Z.Cut

Schichttyp	ZrN (Zirkon-Chrom-Nitrid)
Schichtfarbe	gold
Schichtdicke	3 µm
Härte	2.600 HV

Mehrlagige Schicht mit extrem niedrigem Reibwert. Einsatz bei der Bearbeitung von NE-Metallen wie Aluminium, Magnesium und teilweise auch Kunststoffen.



Diamant

Schichttyp	Kristalline Diamantschicht
Schichtfarbe	schwarz
Schichtdicke	4 - 10 µm
Härte	10.000 HV

Kristalline Diamantschicht mit höchster Abrasionsbeständigkeit. Kristalliner Aufbau mit Vorbehandlung für Grafit. Speziell für die Fräsbearbeitung von Grafiten.



Dia.Plus

Schichttyp	Glatte Mehrlagen-Diamantschicht
Schichtfarbe	schwarz
Schichtdicke	4 - 10 µm
Härte	10.000 HV

Glatte Mehrlagen-Diamantschicht mit spezieller Vorbehandlung für erhöhte Schichthaftung. Bearbeitung von hochabrasiven Materialien, insbesondere Carbon



Dia.HC

Schichttyp	Diamantnahe Schicht
Schichtfarbe	schwarz
Schichtdicke	2 - 3 µm
Härte	5.000 HV

Diamantnahe Schicht mit hoher Verschleißfestigkeit und extrem geringem Reibungswert. Geringe Schichtdicke führt zu deutlich geringerer Kantenverrundung am Werkzeug. Speziell für die Bearbeitung von Faserkunststoffen.



Dia.Aero

Schichttyp	Kristalline Diamantschicht
Schichtfarbe	schwarz
Schichtdicke	12 - 14 µm
Härte	10.000 HV

Diamantschicht mit spezieller Vorbehandlung für stark erhöhte Schichthaftung. Bearbeitung von Flugzeugbauteilwerkstoffen mit hoher Klebneigung oder wechselnden Werkstoffeigenschaften: Carbon, CFK-Ti, CFK-Al, ...



Spiralbohrer - Definitionen

Twist Drills - Definitions

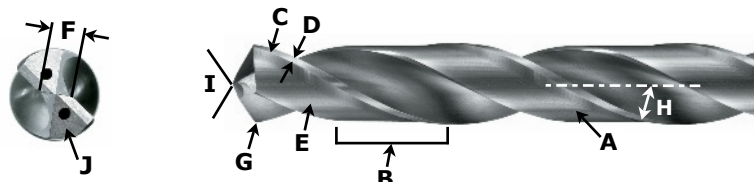

A Spannut

Ist die spiralförmige Nut im Bohrerkörper, die mit dem Spitzenanschliff die Hauptschneide bildet. Sie sorgt für die Abfuhr der Späne.

B Steg / Lippe

Ergibt sich aus Spiralsteigung und Spankammergröße. Sie umfasst Fase, Freistich und Rücken.

C Fase

Zylinderförmige Führungsfläche an der Lippe. Sie führt den Bohrer.

D Fasenbreite

E Rücken

Der im Durchmesser verringerte Teil der Lippe (Hinterschliff).

F Querschneide / Kern

Die Querschneide ist die Verbindung der Hauptschneiden. Der Kern ist der reine Mittelteil des Bohrers ohne die Spirale. Er reicht von der Spitze bis zum Schaft. Normalerweise werden Bohrer mit Kernsteigung vom Schaft zur Spitze verjüngt gefertigt. Je stärker der Kern, desto stabiler der Bohrer.

G Schneidkante und Schneidecke

H Drallwinkel der Spirale

Winkel von Fasenkante zur Bohrerachse. Wird nach den Spanbrucheigenschaften des Werkstoffs variiert.

I Spitze und Spitzenwinkel

Der Winkel wird durch die Hauptschneiden gebildet. Je größer der Winkel, desto mehr Kraft wird zum Eindringen in den Werkstoff benötigt - je spitzer der Winkel, desto bruchempfindlicher der Bohrer.

J Hauptfreifläche

Fehlerbehebung beim Bohren

Troubleshootin for Drills

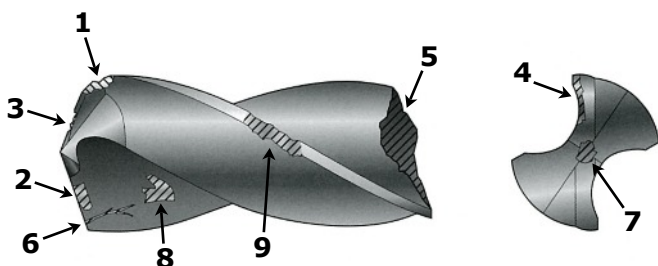

- 1 Verschleiß der Schneidecken
- 2 Kolkverschleiß
- 3 Ausbrüche der Hauptschneide
- 4 Verschleiß der Hauptschneide
- 5 Werkzeugbruch
- 6 Verschleiß der Schneidecken
- 7 Verschleiß der Querschneide
- 8 Aufbauschneide
- 9 Rundfasenverschleiß
- 10 Spanstau
- 11 Bohrungen ausserhalb der Toleranz
- 12 Schlechte Oberflächengüte

Probleme	Fehlerbehebung
1 - 3 - 5 - 7 - 9 - 11 - 12	Mangelnde Stabilität der Maschine
4 - 10	Vorschub erhöhen
1 - 2 - 3 - 5 - 6 - 7 - 8 - 10 - 11 - 12	Vorschub verringern
1 - 3 - 5 - 7 - 9 - 10 - 12	Aufspannung des Werkstücks verbessern
1 - 3 - 5 - 7 - 9 - 11 - 12	Auskräglänge so kurz wie möglich wählen
1 - 3 - 4 - 5 - 7 - 9 - 11	Rundlauffehler > 0,03
1 - 3 - 4 - 5 - 7 - 9 - 11	Rundlaufgenauigkeit erhöhen
1 - 3 - 5 - 6 - 7 - 8 - 10	Kühlmittel prüfen
1 - 3 - 5 - 7 - 9 - 11 - 12	Vorschub beim Eintritt ins Material verringern
1 - 3 - 4 - 5 - 6 - 7 - 9 - 10 - 11 - 12	Schnittgeschwindigkeit verringern

Spitzenanschliffarten

Types of Drill Points

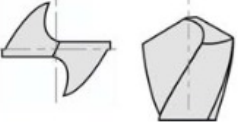
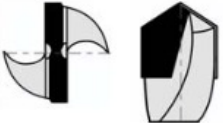
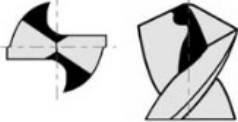
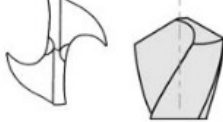
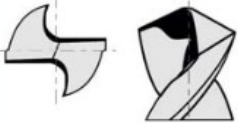
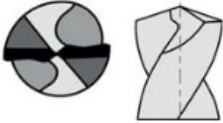
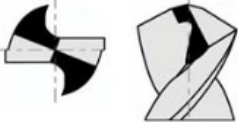
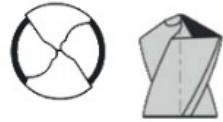
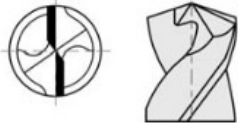
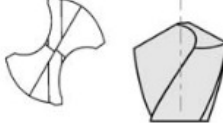
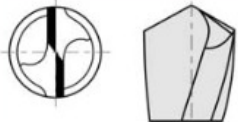
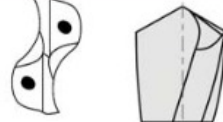
	Kegelmantelanschliff DIN 1412 Grundanschliff für HSS z.B. 111130		Hartmetallbestückt z.B. 658900, 659220/230/240
	1/3 - 2/3 (ähnl. DIN 1412 B) Widerstandsfähige, stabile Hauptschneiden z.B. 411120/127/140/147/180 411290 ... 340(extralang)		Ausgespitzte Querschneide DIN 1412 A Geringer Bohrdruck, gutes Eigenzentrierverhalten
	Kegelmantelanschliff mit korrigierter Hauptschneide z.B. 111170/190		Sirius Patentierter Spitzengeometrie
	Kreuzanschliff DIN 1412 C HSS-E, Karosseriebohrer, selbstzentrierend mit feiner Spitze z.B. 411110/117/160		Altai Elliptic Speziell 118°, Stahlbohrer, selbstzentrierend mit feiner Spitze
	Vielflächenanschliff Spanwinkel korrigiert z.B. 611120/110		Doppelter Kreuzanschliff mit gerundeten Rückenkanten HPC-Bohrer (BC)
	4 Flächen-Anschliff z.B. 411221/227, 611121		HSC-Anschliff für langspanende Werkstoffe z.B. 761540

Wichtigste Herstellungstoleranzen nach DIN 7160/7161

Main manufacturing tolerances

Werte in µm - 0,001 mm

Passung	Nennmaße (Innenmaße) Ø in mm					
	1,0 3,0	3,1 6,0	6,1 10,0	10,1 18,0	18,1 30,0	30,1 50,0
d 9	- 20 - 45	- 30 - 60	- 40 - 76	- 50 - 93	- 65 - 117	- 80 - 142
d 11	- 20 - 80	- 30 - 105	- 40 - 130	- 50 - 160	- 65 - 195	- 80 - 240
e 8	- 20 - 28	- 20 - 38	- 25 - 140	- 32 - 59	- 40 - 73	- 50 - 89
f 8	- 6 - 20	- 10 - 28	- 13 - 35	- 16 - 43	- 20 - 53	- 25 - 64
f 9	- 60 - 31	- 10 - 28	- 13 - 49	- 19 - 59	- 20 - 72	- 25 - 87
h 6	0 - 6	0 - 8	0 - 9	0 - 11	0 - 13	0 - 16
h 7	0 - 10	0 - 12	0 - 15	0 - 18	0 - 21	0 - 25
h 8	0 - 14	0 - 18	0 - 22	0 - 27	0 - 33	0 - 39
h 9	0 - 25	0 - 30	0 - 36	0 - 43	0 - 52	0 - 62
h 10	0 - 40	0 - 48	0 - 58	0 - 70	0 - 84	0 - 100

Passung	Nennmaße (Innenmaße) Ø in mm					
	1,0 3,0	3,1 6,0	6,1 10,0	10,1 18,0	18,1 30,0	30,1 50,0
h 11	0 - 60	0 - 75	0 - 90	0 - 110	0 - 130	0 - 160
h 12	0 - 100	0 - 120	0 - 150	0 - 180	0 - 210	0 - 200
js 11	+ 30 - 30	+ 38 - 38	+ 45 - 45	+ 55 - 55	+ 65 - 65	+ 80 - 80
js 12	+ 50 - 50	+ 60 - 60	+ 75 - 75	+ 90 - 90	+ 105 - 105	+ 125 - 125
js 14	+ 125 - 125	+ 150 - 150	+ 180 - 180	+ 215 - 215	+ 260 - 260	+ 310 - 310
js 16	+ 300 - 300	+ 375 - 375	+ 450 - 450	+ 550 - 550	+ 650 - 650	+ 800 - 800
k 10	+ 40 0	+ 48 0	+ 58 0	+ 70 0	+ 84 0	+ 100 0
k 11	+ 60 0	+ 75 0	+ 90 0	+ 110 0	+ 130 0	+ 160 0
k 12	+ 90 0	+ 120 0	+ 150 0	+ 180 0	+ 210 0	+ 250 0
k 16	+600 0	+ 750 0	+ 900 0	+ 1100 0	+ 1300 0	+ 1600 0

Reibahlen - Definitionen

Reamers - Definitions

- A** Hauptschneide
- B** Nebenschneide
- C** Schneidecke
- D** Anschnittlänge
- E** Freifläche der Hauptschneide
- F** Freifläche der Nebenschneide / Rundschliffase
- G** Spannutt
- λ** Drallwinkel λ

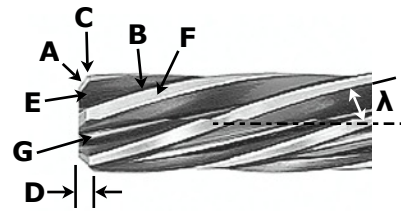

Linksdrall genutete Reibahlen führen die Späne in Vorschubrichtung ab und können nur bei Durchgangsbohrungen verwendet werden. Sie werden für Bohrungen, die z. B. durch eine Längsnut unterbrochen sind, und für langspanende und weiche Werkstoffe verwendet.

Gerade genutete Reibahlen eignen sich für Bohrungen ohne Unterbrechungen, für Grundlochbohrungen und für harte und spröde Werkstoffe.

Fehlerbehebung beim Reiben

Troubleshooting for Reamers

- | | |
|--------------------------------------|--|
| 1 Zu kleine Bohrung | 5 Reibahle bricht aus |
| 2 Zu große Bohrung | 6 Schlechte Oberflächengüte |
| 3 Konische Bohrung | 7 Vorschubriefen in der Bohrung |
| 4 Reibahle klemmt oder bricht | |

Probleme	Fehlerbehebung
1	Schnittgeschwindigkeit erhöhen
2 - 6	Schnittgeschwindigkeit verringern
1 - 6	Vorschub erhöhen
2	Vorschub verringern
1 - 2 - 6	Kühl-/ Schmiermittel prüfen
1 - 4 - 5	Werkzeugmaße prüfen
1 - 6	Reibahle stumpf
1 - 4 - 5 - 6	Zu geringes Bearbeitungsaufmaß
2 - 3	Rundlauffehler Reibahle
2 - 3	Rundlauffehler Aufnahme
2 - 3	Rundlauffehler Spindel
2	Anschnitt der Reibahle zu kurz
2 - 3 - 6	Fehlerhafter Anschnitt
3	Vorbohrung und Reibachse fluchten nicht
3	Pendelhalter verwenden
4 - 5 - 6	Rundschliffase zu breit
4 - 5	Werkstoff neigt zum Klemmen
4 - 5	Schälreibahle verwenden
7	Werkzeug auf Schneidenausbruch und -aufbau prüfen
7	Werkzeugwechsel

Passungsreibahlen - DIN 1420 (Auszug)

Herstellungstoleranzen für Reibahlen (Werte in µm)

Special Tolerance Reamers

Nenn-Ø d1 in mm von bis		C8	C9	C10	C11
1,00	3,00	+ 71 + 66	+ 81 + 72	+ 94 + 80	+ 111 + 90
3,01	6,00	+ 85 + 78	+ 95 + 84	+ 110 + 93	+ 133 + 106
6,01	10,00	+ 98 + 90	+ 110 + 97	+ 129 + 108	+ 156 + 124
10,01	18,00	+ 117 + 107	+ 131 + 115	+ 154 + 129	+ 188 + 149
18,01	30,00	+ 138 + 126	+ 154 + 135	+ 181 + 151	+ 220 + 174
30,01	40,00	+ 153 + 139	+ 172 + 150	+ 205 + 170	+ 256 + 200
40,01	50,00	+ 163 + 149	+ 182 + 160	+ 215 + 180	+ 266 + 210
50,01	65,00	+ 179 + 162	+ 202 + 176	+ 242 + 200	+ 301 + 234

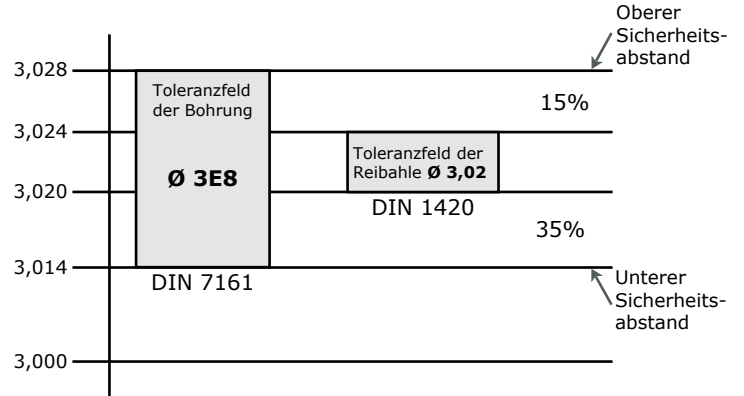

Viele Passungen sind im 1/100-Bereich möglich:
 Beispiel: Ø3 E8 = +25/+20
 3,020 - 3,025 (Toleranzbereich der Passung)
 + 0/0,003 (+ Toleranzbereich der 1/100-Reibahlen)
 = 3,02 (1/100-Reibahle möglich!)

Toleranzen unserer 1/100-Reibahlen:
 Bis Ø 3,00 = 0/+ 0,003
 Bis Ø 6,00 = 0/+ 0,004
 Ab Ø 6,01 = 0/+ 0,005

Nenn-Ø d1 in mm von bis		D8	D9	D10	D11	E7	E8	E9	F6	F7	F8	F9	G6	G7	H6	H7	H8
1,00	3,00	+ 31 + 26	+ 41 + 32	+ 54 + 40	+ 71 + 50	+ 22 + 18	+ 25 + 20	+ 35 + 26	+ 11 + 8	+ 14 + 10	+ 17 + 12	+ 27 + 18	+ 7 + 4	+ 10 + 6	+ 5 + 2	+ 8 + 4	+ 11 + 6
3,01	6,00	+ 45 + 38	+ 55 + 44	+ 70 + 53	+ 93 + 66	+ 30 + 25	+ 35 + 28	+ 45 + 34	+ 16 + 13	+ 20 + 15	+ 25 + 18	+ 35 + 24	+ 10 + 7	+ 14 + 9	+ 6 + 3	+ 10 + 5	+ 15 + 8
6,01	10,00	+ 58 + 50	+ 70 + 57	+ 89 + 68	+ 116 + 84	+ 37 + 31	+ 43 + 35	+ 55 + 42	+ 20 + 16	+ 25 + 19	+ 31 + 23	+ 43 + 30	+ 12 + 8	+ 17 + 11	+ 7 + 3	+ 12 + 6	+ 18 + 10
10,01	18,00	+ 72 + 62	+ 86 + 76	+ 109 + 84	+ 143 + 104	+ 47 + 40	+ 54 + 44	+ 68 + 52	+ 25 + 21	+ 31 + 24	+ 38 + 28	+ 52 + 36	+ 15 + 11	+ 21 + 14	+ 9 + 5	+ 15 + 8	+ 22 + 12
18,01	30,00	+ 93 + 81	+ 109 + 90	+ 136 + 106	+ 175 + 129	+ 57 + 49	+ 68 + 56	+ 84 + 65	+ 31 + 26	+ 37 + 29	+ 48 + 36	+ 64 + 45	+ 18 + 13	+ 24 + 16	+ 11 + 6	+ 17 + 9	+ 28 + 16
30,01	50,00	+ 113 + 99	+ 132 + 110	+ 165 + 130	+ 216 + 160	+ 71 + 62	+ 83 + 69	+ 102 + 80	+ 38 + 32	+ 46 + 37	+ 58 + 44	+ 77 + 55	+ 22 + 16	+ 30 + 21	+ 13 + 7	+ 21 + 12	+ 33 + 19
50,01	80,00	+ 139 + 122	+ 162 + 136	+ 202 + 160	+ 261 + 194	+ 85 + 74	+ 99 + 82	+ 122 + 96	+ 46 + 39	+ 55 + 44	+ 69 + 52	+ 92 + 66	+ 26 + 19	+ 35 + 24	+ 16 + 9	+ 25 + 14	+ 39 + 22

Nenn-Ø d1 in mm von bis		H9	H10	H11	H12	J6	J7	J8	JS7	JS8	JS9	K6	K7	K8	M6	M7	M8
1,00	3,00	+ 21 + 12	+ 34 + 20	+ 51 + 30	+ 85 + 50	+ 1 - 2	+ 2 - 2	+ 3 - 2	+ 3 - 1	+ 4 - 1	+ 8 - 1	- 1 - 4	- 2 - 6	- 3 - 8	- 3 - 6	- 4 - 8	
3,01	6,00	+ 25 + 14	+ 40 + 23	+ 63 + 36	+ 102 + 60	+ 3 0	+ 4 - 1	+ 7 0	+ 4 - 1	+ 6 - 1	+ 10 - 1	0 - 3	+ 1 - 4	+ 2 - 5	- 3 - 6	- 2 - 7	- 1 - 8
6,01	10,00	+ 30 + 17	+ 49 + 28	+ 76 + 44	+ 127 + 74	+ 3 0	+ 5 - 1	+ 8 0	+ 5 - 1	+ 7 - 1	+ 12 - 1	0 - 4	+ 2 - 4	+ 2 - 6	- 5 - 9	- 3 - 9	- 3 - 11
10,01	18,00	+ 36 + 20	+ 59 + 34	+ 93 + 54	+ 153 + 90	+ 4 0	+ 7 0	+ 10 0	+ 6 - 1	+ 9 - 1	+ 15 - 1	0 - 4	+ 3 - 4	+ 3 - 7	- 6 - 10	- 3 - 10	- 3 - 11
18,01	30,00	+ 44 + 25	+ 71 + 41	+ 110 + 63	+ 178 + 104	+ 6 + 1	+ 8 0	+ 15 + 3	+ 7 - 1	+ 11 - 1	+ 18 - 1	0 - 5	+ 2 - 6	+ 5 - 8	- 6 - 11	- 4 - 12	- 1 - 13
30,01	50,00	+ 52 + 30	+ 85 + 50	+ 136 + 80	+ 212 + 124	+ 7 + 1	+ 10 + 1	+ 18 + 4	+ 8 - 1	+ 13 - 1	+ 21 - 1	0 - 6	+ 3 - 6	+ 6 - 8	- 7 - 13	- 4 - 13	- 1 - 15
50,01	80,00	+ 62 + 36	+ 102 + 60	+ 161 + 94	+ 225 + 150	+ 10 + 3	+ 13 + 2	+ 21 + 4	+ 10 - 1	+ 16 - 1	+ 25 - 1	+ 1 - 6	+ 4 - 7	+ 7 - 10	- 8 - 15	- 5 - 16	- 2 - 19

Nenn-Ø d1 in mm von bis		N6	N7	N8	N9	N10	N11	P6	P7
1,00	3,00	- 5 - 8	- 6 - 10	- 7 - 12	- 8 - 17	- 10 - 24	- 13 - 34	- 7 - 10	- 8 - 12
3,01	6,00	- 7 - 10	- 6 - 11	- 5 - 12	- 5 - 16	- 8 - 25	- 12 - 39	- 11 - 14	- 10 - 15
6,01	10,00	- 9 - 13	- 7 - 13	- 7 - 15	- 6 - 19	- 9 - 30	- 14 - 46	- 14 - 18	- 12 - 18
10,01	18,00	- 11 - 15	- 8 - 15	- 8 - 18	- 7 - 23	- 11 - 36	- 17 - 56	- 17 - 21	- 14 - 21
18,01	30,00	- 13 - 18	- 11 - 19	- 8 - 20	- 8 - 27	- 13 - 43	- 20 - 66	- 20 - 25	- 18 - 26
30,01	50,00	- 15 - 21	- 12 - 21	- 9 - 23	- 10 - 32	- 15 - 50	- 24 - 80	- 24 - 30	- 21 - 30
50,01	80,00	- 17 - 24	- 14 - 25	- 11 - 28	- 12 - 38	- 18 - 60	- 29 - 96	- 29 - 36	- 26 - 37

Nenn-Ø d1 in mm von bis		R6	R7	S6	S7	U6	U7	Z10
1,00	3,00	- 11 - 14	- 12 - 16	- 15 - 18	- 16 - 20	- 19 - 22	- 20 - 24	- 32 - 46
3,01	6,00	- 14 - 17	- 13 - 18	- 18 - 21	- 17 - 22	- 22 - 25	- 21 - 26	- 43 - 60
6,01	10,00	- 18 - 22	- 16 - 22	- 22 - 26	- 20 - 26	- 27 - 31	- 25 - 31	- 51 - 72
10,01	14,00	- 22 - 26	- 19 - 26	- 27 - 31	- 24 - 31	- 32 - 36	- 29 - 36	- 61 - 86
14,01	18,00	- 22 - 26	- 19 - 26	- 27 - 31	- 24 - 31	- 32 - 36	- 29 - 36	- 71 - 96
18,01	24,00	- 26 - 31	- 24 - 32	- 33 - 38	- 31 - 39	- 39 - 44	- 37 - 45	- 86 - 116
24,01	30,00	- 26 - 31	- 26 - 32	- 33 - 38	- 31 - 39	- 46 - 51	- 44 - 52	- 101 - 131
30,01	40,00	- 32 - 38	- 29 - 38	- 41 - 47	- 38 - 47	- 58 - 64	- 55 - 65	- 127 - 162
40,01	50,00	- 32 - 38	- 29 - 38	- 41 - 47	- 38 - 47	- 68 - 74	- 65 - 74	- 151 - 186
50,01	65,00	- 38 - 45	- 35 - 46	- 50 - 57	- 47 - 58	- 84 - 91	- 81 - 92	- 190 - 232



Passungsauswahl für 1/100-Maschinenreibahlen nach DIN 1420

Selection of fit for reamers

Werte in mm - 0,01 mm

Bohrung Ø mm	Passung (Fit)																
	C8	C9	C10	C11	D8	D9	D10	D11	E7	E8	E9	F6	F7	F8	F9	G6	G7
1,0	1,07	•	1,08	1,10	1,03	•	1,04	1,06	1,02	1,02	1,03	1,01	1,01	1,01	1,02	•	•
2,0	2,07	•	2,08	2,10	2,03	•	2,04	2,06	2,02	2,02	2,03	2,01	2,01	2,01	2,02	•	•
3,0	3,07	•	3,08	3,10	3,03	•	3,04	3,06	3,02	3,02	3,03	3,01	3,01	3,01	3,02	•	•
4,0	4,08	4,09	4,10	4,12	4,04	4,05	4,06	4,08	•	4,03	4,04	•	•	4,02	4,03	•	4,01
5,0	5,08	5,09	5,10	5,12	5,04	5,05	5,06	5,08	•	5,03	5,04	•	•	5,02	5,03	•	5,01
6,0	6,08	6,09	6,10	6,12	6,04	6,05	6,06	6,08	•	6,03	6,04	•	•	6,02	6,03	•	6,01
7,0	7,09	7,10	7,12	7,15	7,05	7,06	7,08	7,11	7,03	7,04	7,05	•	7,02	•	7,04	•	7,01
8,0	8,09	8,10	8,12	8,15	8,05	8,06	8,08	8,11	8,03	8,04	8,05	•	8,02	•	8,04	•	8,01
9,0	9,09	9,10	9,12	9,15	9,05	9,06	9,08	9,11	9,03	9,04	9,05	•	9,02	•	9,04	•	9,01
10,0	10,09	10,10	10,12	10,15	10,05	10,06	10,08	10,11	10,03	10,04	10,05	•	10,02	•	10,04	•	10,01
11,0	11,11	11,12	11,14	11,18	•	11,08	11,10	11,13	11,04	11,05	11,06	11,02	•	11,03	11,04	11,01	•
12,0	12,11	12,12	12,14	12,18	•	12,08	12,10	12,13	12,04	12,05	12,06	12,02	•	12,03	12,04	12,01	•
14,0	14,11	14,12	14,14	14,18	•	14,08	14,10	14,13	14,04	14,05	14,06	14,02	•	14,03	14,04	14,01	•
16,0	16,11	16,12	16,14	16,18	•	16,08	16,10	16,13	16,04	16,05	16,06	16,02	•	16,03	16,04	16,01	•
18,0	18,11	18,12	18,14	18,18	•	18,08	18,10	18,13	18,04	18,05	18,06	18,02	•	18,03	18,04	18,01	•
20,0	20,13	20,14	20,17	20,19	20,08	20,10	20,13	20,17	20,05	20,06	20,07	•	20,03	20,04	20,04	•	20,02
Ø mm	H6	H7	H8	H9	H10	H11	H12	J6	J7	J8	JS7	JS8	JS9	K6	K7	K8	M6
1,0	•	•	•	•	1,02	1,04	1,08	•	1,00	1,00	1,00	1,00	1,00	•	•	•	•
2,0	•	•	•	•	2,02	2,04	2,08	•	2,00	2,00	2,00	2,00	2,00	•	•	•	•
3,0	•	•	•	•	3,02	3,04	3,08	•	3,00	3,00	3,00	3,00	3,00	•	•	•	•
4,0	•	•	4,01	4,02	4,03	4,05	4,09	4,00	4,00	4,00	4,00	4,00	4,00	•	•	•	•
5,0	•	•	5,01	5,02	5,03	5,05	5,09	5,00	5,00	5,00	5,00	5,00	5,00	•	•	•	•
6,0	•	•	6,01	6,02	6,03	6,05	6,09	6,00	6,00	6,00	6,00	6,00	6,00	•	•	•	•
7,0	•	•	7,01	7,02	7,04	7,07	7,12	7,00	7,00	7,00	7,00	7,00	7,00	•	•	•	•
8,0	•	•	8,01	8,02	8,04	8,07	8,12	8,00	8,00	8,00	8,00	8,00	8,00	•	•	•	•
9,0	•	•	9,01	9,02	9,04	9,07	9,12	9,00	9,00	9,00	9,00	9,00	9,00	•	•	•	•
10,0	•	•	10,01	10,02	10,04	10,07	10,12	10,00	10,00	10,00	10,00	10,00	10,00	•	•	•	•
11,0	•	11,01	•	11,03	11,05	11,08	11,14	11,00	11,00	11,00	11,00	11,00	11,00	•	•	•	10,99
12,0	•	12,01	•	12,03	12,05	12,08	12,14	12,00	12,00	12,00	12,00	12,00	12,00	•	•	•	11,99
14,0	•	14,01	•	14,03	14,05	14,08	14,14	14,00	14,00	14,00	14,00	14,00	14,00	•	•	•	13,99
16,0	•	16,01	•	16,03	16,05	16,08	16,14	16,00	16,00	16,00	16,00	16,00	16,00	•	•	•	15,99
18,0	•	18,01	•	18,03	18,05	18,08	18,14	18,00	18,00	18,00	18,00	18,00	18,00	•	•	•	17,99
20,0	•	20,01	20,02	20,03	20,06	20,10	20,17	20,00	20,00	20,01	20,00	20,00	20,00	•	•	20,00	19,99
Ø mm	M7	M8	N6	N7	N8	N9	N10	N11	P6	P7	R6	R7	S6	S7	U6	U7	Z10
1,0	•	•	•	0,99	0,99	0,98	0,98	0,98	0,99	0,99	•	•	•	0,98	•	•	0,96
2,0	•	•	•	1,99	1,99	1,98	2,98	1,98	1,99	1,99	•	•	•	1,98	•	•	1,96
3,0	•	•	•	2,99	2,99	2,98	2,98	2,98	2,99	2,99	•	•	•	2,98	•	•	2,96
4,0	•	3,99	3,99	3,99	3,99	3,99	3,98	3,98	•	•	•	•	3,98	3,98	•	•	3,95
5,0	•	4,99	4,99	4,99	4,99	4,99	4,98	4,98	•	•	•	•	4,98	4,98	•	•	4,95
6,0	•	5,99	5,99	5,99	5,99	5,99	5,98	5,98	•	•	•	•	5,98	5,98	•	•	5,95
7,0	6,99	6,99	•	6,99	6,99	6,98	6,98	6,98	•	•	•	6,98	•	•	6,97	6,97	6,94
8,0	7,99	7,99	•	7,99	7,99	7,98	7,98	7,98	•	•	•	7,98	•	•	7,97	7,97	7,94
9,0	8,99	8,99	•	8,99	8,99	8,98	8,98	8,98	•	•	•	8,98	•	•	8,97	8,97	8,94
10,0	9,99	9,99	•	9,99	9,99	9,98	9,98	9,98	•	•	•	9,98	•	•	9,97	9,97	9,94
11,0	10,99	10,99	•	•	10,99	10,98	10,98	10,97	•	10,98	•	•	10,97	10,97	•	•	10,93
12,0	11,99	11,99	•	•	11,99	11,98	11,98	11,97	•	11,98	•	•	11,97	11,97	•	•	11,93
14,0	13,99	13,99	•	•	13,99	13,98	13,98	13,97	•	13,98	•	•	13,97	13,97	•	•	13,93
16,0	15,99	15,99	•	•	15,99	15,98	15,98	15,97	•	15,98	•	•	15,97	15,97	•	•	15,92
18,0	17,99	17,99	•	•	17,99	17,98	17,98	17,97	•	17,98	•	•	17,97	17,97	•	•	17,92
20,0	19,99	19,99	•	19,98	19,98	19,98	20,98	20,97	•	•	19,97	19,97	•	19,96	•	•	19,91

• = Keine 1/100-Maschinenreibahle möglich, muss auf Passung geschliffen werden.

Die Werte können um 0,001 mm abweichen.

Theoretische 1/100 Abmessung, aber kein Standardartikel (Passungsreibahle).

Fräser - Definitionen

End Mills - Definitions

- A** Schneidenecke
- B** Hauptschneide
- C** Nebenschneide
- D** Freiflächenfase der Hauptschneide
- E** Freifläche der Hauptschneide
- F** Freifläche der Nebenschneide
- G** Spannut
- α Freiwinkel α
Die Größe der Winkel richtet sich nach dem zu bearbeitenden Werkstoff
- β Keilwinkel β
- γ Spanwinkel γ
- λ Drallwinkel λ
Durch den Winkel λ zwischen Schneidenlinie und Längsachse des Fräasers ist ein Maß für die Steigung (Drall) gegeben. Damit auch bei Fräsern mit kleiner Zähnezahl (weiche Werkstoffe) mehrere Zähne gleichzeitig schneiden, muss der Drallwinkel entsprechend größer gewählt werden als bei Fräsern mit großer Zähnezahl (härtere Werkstoffe).

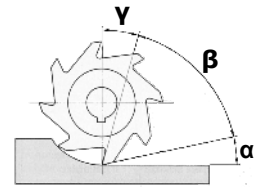
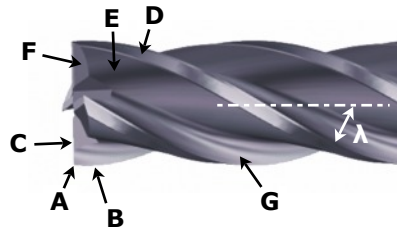

Fehlerbehebung beim Fräsen

Troubleshooting for End Mills

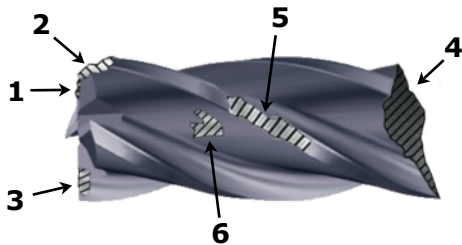

- 1** Ausbrüche der Schneiden
- 2** Verschleiß der Schneiden
- 3** Kolkverschleiß
- 4** Werkzeugbruch
- 5** Verschleiß der Freiflächen
- 6** Aufbauschneide
- 7** Spanstau
- 8** Vibrationen, Rattern
- 9** Schlechte Oberflächengüte
- 10** Werkstückausbruch
- 11** Überlastung der Maschine

Probleme	Fehlerbehebung
1 - 8 - 9	Mangelnde Stabilität der Maschine
2 - 5 - 6	Vorschub erhöhen
1 - 3 - 4 - 7 - 9 - 10 - 11	Vorschub verringern
1 - 8	Stabilität des Werkstücks
3 - 5 - 6 - 8	Kühlmittel/Kühlmitteldruck prüfen
4 - 6 - 7 - 8 - 9 - 10 - 11	Schnitttiefe verringern
2 - 3 - 5 - 8 - 11	Schnittgeschwindigkeit verringern
9	Drallwinkel erhöhen
2 - 3 - 5	Verschleißfestigkeit des Hartmetalls erhöhen
9	Zähnezahl erhöhen
1 - 4 - 8 - 10	Auskraglänge verkürzen
1 - 4 - 6 - 9 - 10	Schnittgeschwindigkeit erhöhen
1 - 2	Schneidphase erhöhen

Anwendungen für Fräserwerkzeuge

Milling Applications

Besäumen - Konturfräsen	Eckfräsen	Nutenfräsen	Stirn- und Planfräsen
Große Schnitttiefe a_p Geringere Bearbeitungsbreite a_e	Große Schnitttiefe a_p Geringe Bearbeitungsbreite a_e	Bearbeitungsbreite $D_C \times 1$ Schnitttiefe $a_p = D_C \times 1$	Geringe Schnitttiefe a_p Bearbeitungsbreite bis $D_C \times 1$
Bohren	Schräg eintauchen	Zeilenfräsen (Vorfräsen)	Tauchfräsen
Bearbeitung nur in Z	Eintauchen in Z in einem Winkel Wirtschaftlicher als Bohren	Bohren in Z Dann Linearbearbeitung	Durch Bohrbearbeitung in Z tiefe Nuten vorbearbeiten
Kopierfräsen	Kopierfräsen	Zirkularfräsen	Umfang-Zirkularfräsen
Geringe Spanquerschnitte mit großen Radiuswerkzeugen	Geringe Spanquerschnitte mit großen Radiuswerkzeugen	Borbearbeitung mit zirkularer Zustellung in Z	Außenbearbeitung mit zirkularer Zustellung in Z

Fräsertypen, Anwendungsgebiete und Eigenschaften

Types of End Mills, Applications and Properties

Typ	Anwendungsgebiete	Oberflächengüten	Materialabnahme
N	Schlichtverzahnung mit Spiralsteigung 30° Zerspanung von Bau-, Einsatz- und Vergütungsstählen, für kurzspanende NE-Metalle bzw. Materialien bis - 1.200 N/mm ² Festigkeit bei HSS-Fräsern - 1.600 N/mm ² Festigkeit bei VHM-Fräsern	Sehr gut	Geringe bis mittlere
NF	Flache Schrupp-/Schlichtverzahnung Zerspanung von normalen Werkstoffen bis ca. - 1.200 N/mm ² Festigkeit bei HSS-Fräsern - 1.600 N/mm ² Festigkeit bei VHM-Fräsern	Ausreichend	Geringe bis große
NR	Normale Schrupp-Kordelverzahnung Zerspanung von normalen Werkstoffen bis ca. - 1.000 N/mm ² Festigkeit bei HSS-Fräsern - 1.200 N/mm ² Festigkeit bei VHM-Fräsern	Schichten nötig	Mittlere bis große
NRf	Feine Schrupp-Kordelverzahnung Zerspanung von Werkstoffen mit höherer Festigkeit bis ca. - 1.400 N/mm ² Festigkeit bei HSS-Fräsern - 1.600 N/mm ² Festigkeit bei VHM-Fräsern	Schichten nötig	Mittlere bis große
W	Schlichtverzahnung mit Spiralsteigung 45° Zerspanung von weichen Werkstoffen wie Aluminium, Aluminium-Legierungen und NE-Metalle bis ca. - 600 N/mm ² Festigkeit	Sehr gut	Geringe bis mittlere
WR	Grobe Schrupp-Kordelverzahnung Zerspanung von Aluminium, NE-Metallen und weichen Stählen bis ca. - 600 N/mm ² Festigkeit	Schichten nötig	Mittlere bis große
WX	Pyramidenverzahnung Ein spezielles Schleifverfahren kombiniert polierte Spannuten und extrem scharfe Schneidkanten. Dies führt zu geringen Reibungskoeffizienten und hoher Schnitthaltigkeit. Hauptsächlich für die Bearbeitung von CFK und GFK ausgelegt, bieten wir 3 verschiedene Profiltypen - Fein, Mittel, Grob - sowie 3 verschiedene Stirnverzahnungen zum Bohren, Stirnfräsen und Besäumen.	Schichten ggf. nötig	Mittlere bis große
WL	Linksspirale, rechtsschneidend Spanabfuhr nach unten. Werkzeug wird angepresst.	Sehr gut	Geringe bis mittlere
H	Schlichtverzahnung mit hoher Spiralsteigung 55° Zerspanung von gehärteten Werkstoffen (HSC-Bearbeitung) und Hartguss bis ca. - 62 HRC Festigkeit	Sehr gut	Geringe bis mittlere
HRf	Extra feine Schrupp-Kordelverzahnung Zerspanung von Werkstoffen mit höherer Festigkeit bis ca. - 1.400 N/mm ² Festigkeit bei HSS-Fräsern - 1.600 N/mm ² Festigkeit bei VHM-Fräsern	Schichten nötig	Mittlere bis große
UT	Ungleiche Teilung Durch sie kann vibrationsfrei gearbeitet werden. Im Vergleich zu Standardfräsern sind höhere Vorschübe möglich.	Schruppen und Schichten möglich	Mittlere bis große

Gleichlaufräsen

Down milling

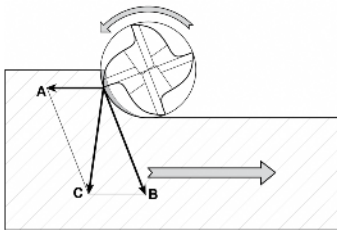

Die Drehrichtung des Fräasers und der Vorschub des Werkstücks gehen in die gleiche Richtung. Beim Eintauchen des Fräasers wird das Material mit der größten Spandicke abgetragen und beim Verlassen des Material ist die Spanstärke am geringsten.

Wichtigste Merkmale:

- Verringerung der Vibrationen
- Hohe Oberflächengüte
- Längere Haltbarkeit der Schneiden
- Möglichkeit, eine größere Schnittgeschwindigkeit zu verwenden

Gegenlaufräsen

Up milling

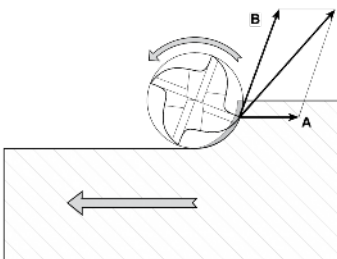

Die Drehrichtung des Fräasers und der Vorschub des Werkstücks gehen in entgegengesetzter Richtung.

Beim Eintauchen des Fräasers wird das Material mit der geringsten Spandicke abgetragen und beim Verlassen des Material ist die Spanstärke am größten.

Wichtigste Merkmale:

- Stärkere Vibrationen infolge der Zunahme der Schnittkraft
- Geringere Haltbarkeit des Fräasers infolge der stärkeren Reibung der Schneiden im ersten Arbeitsabschnitt
- Die vertikale Komponente der Schnittkraft führt zum Abheben des Werkstücks vom Tisch.

HSC - High Speed Cutting

Hochgeschwindigkeitsfräsen bedeutet Verringerung der Bearbeitungszeiten und der Fertigungskosten, unter Verwendung von hohen Schnittgeschwindigkeiten und von sowohl radial als auch axial relativ reduzierten Schnitttiefen. Die HSC-Fräser weisen eine besonders optimierte Geometrie auf und werden mit Extrafeinkorn-Hartmetall hergestellt.

Ratschläge für die HSC-Bearbeitung

Recommendations for HSC-Milling

<p>Wir empfehlen soweit wie möglich den Schnitt auf Zug. Den größten Span erhält man über die optimale Schnittgeschwindigkeit.</p>	<p>Das Gleichlaufräsen ist qualitativ besser als das Gegenlaufräsen. Man erreicht eine bessere Oberflächenrauheit, weniger Geräusche und eine höhere Standzeit der Werkzeuge.</p>	<p>Man sollte den Fräser möglichst leicht in die Richtung des Vorschubs neigen, um die Bearbeitung im Zentrum des Werkzeugs zu vermeiden, wo die Schnittgeschwindigkeit gleich 0 ist.</p>
<p>Die ideale Neigung ist 15° in Vorschubrichtung und erlaubt dem Fräser mit einer Schnittgeschwindigkeit von 80% der möglichen Höchstgeschwindigkeit zu arbeiten, bezogen auf den nominalen Durchmesser des Fräasers.</p>	<p>Keine senkrechten Tauchschnitte im Werkstück durchführen; wir schlagen spiralförmige oder Rampenbewegungen vor.</p>	

Gewindebohrer - Definitionen

Taps - Definitions

- A** Anschnittdurchmesser
- B** Anschnitt
- C** Gewindesteigung
- D** Flankenwinkel
- E** Spannut
- F** Spanwinkel
- G** Steg/Stollen
Zahnstollenbreite
- H** Nutenbreite

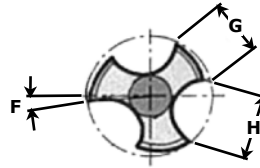
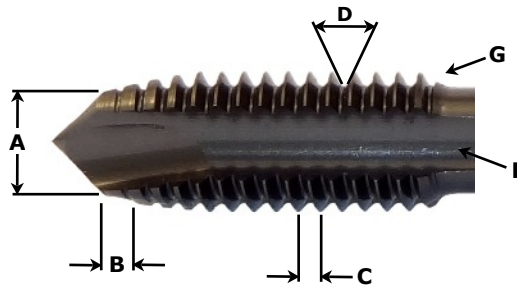

Fehlerbehebung beim Gewinden

Troubleshooting for Taps

- | | |
|-----------------------------------|--|
| 1 Ausgerissenes Gewinde | 5 Spanstau in den Nuten |
| 2 Bruch des Gewindebohrers | 6 Schlechte Oberfläche am Gewinde |
| 3 Gewinde zu groß | 7 Überhitzung des Gewindebohrers |
| 4 Gewindebohrer bricht aus | 8 Verschleiß am Gewindebohrer |

Probleme	Fehlerbehebung
1 - 4 - 6	Geeigneten Spanwinkel verwenden
1 - 4 - 5 - 6 - 8	Geeignete Gewindebohrerform verwenden
1 - 2	Bohrungsdurchmesser prüfen
1 - 3 - 4 - 5 - 6 - 7 - 8	Kühl-/Schmiermittel prüfen
2	Gewindebohrerschleif vor dem Schneiden prüfen
2 - 3	Anschnitt prüfen
2 - 4 - 8	Schnittgeschwindigkeit verringern
3	Rundlauffehler der Spindel/Werkzeugaufnahme
3	Versatz vom Gewindebohrer zur Bohrung beheben
3	Maschine bzw. Vorrichtung prüfen/wechseln
3	Spanstau in den Nuten vermeiden
3	Werkstückspannung verbessern
4	Klemmen der Späne beim Rücklauf vermeiden
3 - 6 - 7	Gewindebohrer nachschleifen/wechseln
8	Gewindebohrer mit Beschichtung verwenden

Anschnittformen

Tap Chamfer Types

Form A 6-8 Gang, gerade Für kurze Durchgangslöcher		Form C 2-3 Gang, mit Spirale Für Grundlöcher	
Form B 4-5 Gang mit Schälanschnitt Für alle Durchgangslöcher		Form C 2-3 Gang, gerade Für Grund- und Durchgangslöcher	
Form B-AZ 4-5 Gang, Schälanschnitt und ausgesetzte Zähne Für Durchgangslöcher		Form C-AZ 2-3 Gang mit ausgesetzten Zähnen Für Grund- und Durchgangslöcher	
Form D 4-5 Gang Für Grund- und Durchgangslöcher		Form E 1,5-2 Gang Für Grundlöcher	

Gewindearten

Thread Types

M Metrisches ISO-Gewinde	MF Metrisches ISO-Feingewinde	UN Unified Thread Inch-Gewinde
Für allgemeine Regelgewinde	Für allgemeine Feingewinde	Für allgemeine UN Regelgewinde (Unified National) (Amerikan. Einheitsgewinde mit konstanter Steigung)
G Zylindrisches Rohrgewinde	PG Stahlpanzerrohrgewinde	NPT National Pipe Taper
Für nicht im Gewinde dichtende Verbindungen	Für zylindrisches Rundgewinde	Für Gewinderohre und Fittings (National Pipe Taper) (Amerikanisches kegliges Standard Rohrgewinde 1:16)
BSP Zylindrisches Rohrgewinde (wie G)	BSPT Kegliges Rohrgewinde	BSW Zylindrisches Whitworth-Gewinde
Für nicht im Gewinde dichtende Verbindungen (British Standard Pipe)	Für Innengewinde für Gewinderohre und Fittings (British Standard Pipe Taper)	Für Gewinde für Rohre, Rohrverbindungen, Armaturen (British Standard Whitworth)

Empfohlene Kernlochbohrerdurchmesser zum Gewindebohren

Recommended core holes diameter for Taps

M	P in mm	KernlochØ in mm	M	P in mm	KernlochØ in mm	M	P in mm	KernlochØ in mm	M	P in mm	KernlochØ in mm	M	P in mm	KernlochØ in mm	
M	1,0	0,25	0,75	M	3,5	0,60	2,90	M	12,0	1,75	10,20	M	36,0	4,00	32,00
M	1,1	0,25	0,85	M	4,0	0,70	3,30	M	14,0	2,00	12,00	M	39,0	4,00	35,00
M	1,2	0,25	0,95	M	4,5	0,75	3,70	M	16,0	2,00	14,00	M	42,0	4,50	37,50
M	1,4	0,30	1,10	M	5,0	0,80	4,20	M	18,0	2,50	15,50	M	45,0	4,50	40,50
M	1,6	0,35	1,25	M	6,0	1,00	5,00	M	20,0	2,50	17,50	M	48,0	5,00	43,00
M	1,8	0,35	1,45	M	7,0	1,00	6,00	M	22,0	2,50	19,50	M	52,0	5,00	47,00
M	2,0	0,40	1,60	M	8,0	1,25	6,80	M	24,0	3,00	21,00	M	56,0	5,50	50,50
M	2,2	0,45	1,75	M	9,0	1,25	7,80	M	27,0	3,00	24,00	M	60,0	5,50	54,50
M	2,5	0,45	2,05	M	10,0	1,50	8,50	M	30,0	3,50	26,50	M	64,0	6,00	58,00
M	3,0	0,50	2,50	M	11,0	1,50	9,50	M	33,0	3,50	29,50	M	68,0	6,00	62,00
MF	P in mm	KernlochØ in mm	MF	P in mm	KernlochØ in mm	MF	P in mm	KernlochØ in mm	MF	P in mm	KernlochØ in mm	MF	P in mm	KernlochØ in mm	
MF	2,5	0,35	2,15	MF	13,0	1,00	12,00	MF	22,0	0,75	21,25	MF	32,0	3,0	29,00
MF	2,6	0,35	2,25	MF	13,0	1,50	11,50	MF	22,0	1,00	21,00	MF	33,0	1,5	31,50
MF	3,0	0,35	2,65	MF	14,0	0,50	13,50	MF	22,0	1,25	20,75	MF	33,0	2,0	31,00
MF	3,5	0,35	3,15	MF	14,0	0,75	13,20	MF	22,0	1,50	20,50	MF	33,0	3,0	30,00
MF	4,0	0,35	3,65	MF	14,0	1,00	13,00	MF	22,0	2,00	20,00	MF	34,0	1,0	33,00
MF	4,0	0,50	3,50	MF	14,0	1,25	12,80	MF	23,0	1,00	22,00	MF	34,0	1,5	32,50
MF	4,5	0,50	4,00	MF	14,0	1,50	12,50	MF	23,0	1,50	21,50	MF	34,0	2,0	32,00
MF	5,0	0,50	4,50	MF	15,0	0,75	14,25	MF	24,0	0,50	23,50	MF	35,0	1,0	34,00
MF	5,0	0,75	4,25	MF	15,0	1,00	14,00	MF	24,0	0,75	23,25	MF	35,0	1,5	33,50
MF	5,5	0,50	5,00	MF	15,0	1,50	13,50	MF	24,0	1,00	23,00	MF	35,0	2,0	33,00
MF	6,0	0,50	5,50	MF	16,0	0,50	15,50	MF	24,0	1,25	22,75	MF	36,0	1,0	35,00
MF	6,0	0,75	5,20	MF	16,0	0,75	15,25	MF	24,0	1,50	22,50	MF	36,0	1,5	34,50
MF	7,0	0,50	6,50	MF	16,0	1,00	15,00	MF	24,0	2,00	22,00	MF	36,0	2,0	34,00
MF	7,0	0,75	6,20	MF	16,0	1,25	14,75	MF	25,0	1,00	24,00	MF	36,0	3,0	33,00
MF	8,0	0,50	7,50	MF	16,0	1,50	14,50	MF	25,0	1,50	23,50	MF	37,0	1,5	35,50
MF	8,0	0,75	7,20	MF	17,0	1,00	16,00	MF	26,0	1,00	25,00	MF	38,0	1,0	37,00
MF	8,0	1,00	7,00	MF	18,0	0,50	17,50	MF	26,0	1,50	24,50	MF	38,0	1,5	36,50
MF	9,0	0,50	8,50	MF	18,0	0,75	17,25	MF	26,0	2,00	24,00	MF	38,0	2,0	36,00
MF	9,0	0,75	8,20	MF	18,0	1,00	17,00	MF	27,0	1,00	26,00	MF	38,0	3,0	35,00
MF	9,0	1,00	8,00	MF	18,0	1,25	16,75	MF	27,0	1,50	25,50	MF	39,0	1,5	37,50
MF	10,0	0,50	9,50	MF	18,0	1,50	16,50	MF	27,0	2,00	25,00	MF	39,0	2,0	37,00
MF	10,0	0,75	9,20	MF	18,0	2,00	16,00	MF	28,0	1,00	27,00	MF	39,0	3,0	36,00
MF	10,0	1,00	9,00	MF	19,0	1,00	18,00	MF	28,0	1,50	26,50	MF	40,0	1,0	39,00
MF	10,0	1,25	8,80	MF	19,0	1,50	17,50	MF	28,0	2,00	26,00	MF	40,0	1,5	38,50
MF	11,0	1,00	10,00	MF	20,0	0,50	19,50	MF	29,0	1,50	27,50	MF	40,0	2,0	38,00
MF	11,0	1,25	9,80	MF	20,0	0,75	19,25	MF	30,0	1,00	29,00	MF	40,0	3,0	37,00
MF	12,0	0,50	11,50	MF	20,0	1,00	19,00	MF	30,0	1,50	28,50	MF	42,0	1,0	41,00
MF	12,0	0,75	11,20	MF	20,0	1,25	18,75	MF	30,0	2,00	28,00	MF	42,0	1,5	40,50
MF	12,0	1,00	11,00	MF	20,0	1,50	18,50	MF	30,0	2,50	27,50	MF	42,0	2,0	40,00
MF	12,0	1,25	10,80	MF	20,0	2,00	18,00	MF	30,0	3,00	27,00	MF	44,0	1,5	42,50
MF	12,0	1,50	10,50	MF	21,0	1,00	20,00	MF	32,0	1,00	31,00	MF	45,0	2,0	43,00
MF	13,0	0,50	12,50	MF	21,0	1,50	19,50	MF	32,0	1,50	30,50	MF	48,0	2,0	45,00
MF	13,0	0,75	12,25	MF	22,0	0,50	21,50	MF	32,0	2,00	30,00	MF	52,0	2,0	50,00
UNC	Nr.	Gänge/1"	KernlochØ in mm	UNC	Nr.	Gänge/1"	KernlochØ in mm	UNC	Nr.	Gänge/1"	KernlochØ in mm	UNC	Nr.	Gänge/1"	KernlochØ in mm
UNC	1	64	1,55	UNC	6	32	2,85	UNC	5/16"	18	6,60	UNC	5/8"	11	13,50
UNC	2	56	1,85	UNC	8	32	3,50	UNC	3/8"	16	8,00	UNC	3/4"	10	16,50
UNC	3	48	2,10	UNC	10	24	3,90	UNC	7/16"	14	9,40	UNC	7/8"	9	19,50
UNC	4	40	2,35	UNC	12	24	4,50	UNC	1/2"	13	10,80	UNC	1"	8	22,25
UNC	5	40	2,65	UNC	1/4"	20	5,10	UNC	9/16"	12	12,20	UNC	1 1/8"	7	25,00
UNF	Nr.	Gänge/1"	KernlochØ in mm	UNF	Nr.	Gänge/1"	KernlochØ in mm	UNF	Nr.	Gänge/1"	KernlochØ in mm	UNF	Nr.	Gänge/1"	KernlochØ in mm
UNF	0	80	1,25	UNF	5	44	2,70	UNF	1/4"	28	5,50	UNF	9/16"	18	12,90
UNF	1	72	1,55	UNF	6	40	2,95	UNF	5/16"	24	6,90	UNF	5/8"	18	14,50
UNF	2	64	1,85	UNF	8	36	3,50	UNF	3/8"	24	8,50	UNF	3/4"	16	17,50
UNF	3	56	2,15	UNF	10	32	4,10	UNF	7/16"	20	9,90	UNF	7/8"	14	20,40
UNF	4	48	2,40	UNF	12	28	4,60	UNF	1/2"	20	11,50	UNF	1"	12	23,25
BSW	Zoll	Gänge/1"	KernlochØ in mm	BSW	Zoll	Gänge/1"	KernlochØ in mm	G	Zoll	Gänge/1"	KernlochØ in mm	G	Zoll	Gänge/1"	KernlochØ in mm
BSW	3/32"	48	2,10	BSW	3/8"	16	8,00	G	1/8"	28	8,80	G	1"	11	30,75
BSW	1/8"	40	2,35	BSW	7/16"	14	9,40	G	1/4"	19	11,80	G	1 1/8"	11	35,50
BSW	5/32"	32	2,85	BSW	1/2"	12	10,60	G	3/8"	19	15,25	G	1 1/4"	11	39,50
BSW	3/16"	24	3,90	BSW	9/16"	12	12,20	G	1/2"	14	19,00	G	1 3/8"	11	41,50
BSW	7/32"	24	4,50	BSW	5/8"	11	13,50	G	5/8"	14	21,00	G	1 1/2"	11	45,25
BSW	1/4"	20	5,10	BSW	3/4"	10	16,50	G	3/4"	14	24,50	G	1 3/4"	11	51,00
BSW	5/16"	18	6,60	BSW	7/8"	9	19,50	G	7/8"	14	28,25	G	2"	11	57,00
NPT	Zoll	Gänge/1"	KernlochØ in mm	NPT	Zoll	Gänge/1"	KernlochØ in mm	PG	Zoll	Gänge/1"	KernlochØ in mm	PG	Zoll	Gänge/1"	KernlochØ in mm
NPT	1/16"	27	6,15	NPT	3/4"	14	23,00	PG	7,0	20	11,35	PG	21,0	16	26,95
NPT	1/8"	27	8,40	NPT	1"	11,5	29,00	PG	9,0	18	13,95	PG	29,0	16	35,60
NPT	1/4"	18	11,00	NPT	1 1/4"	11,5	37,50	PG	11,0	18	17,35	PG	36,0	16	45,60
NPT	3/8"	18	14,50	NPT	1 1/2"	11,5	44,00	PG	13,5	18	19,15	PG	42,0	16	52,60
NPT	1/2"	14	17,75	NPT	2"	11,5	56,00	PG	16,0	18	21,25	PG	48,0	16	57,90

Empfohlene Kernlochbohrerdurchmesser zum Gewindeformen

Recommended core holes diameter for Cold Forming Taps

M	P in mm	KernlochØ in mm	MF	P in mm	KernlochØ in mm	UNC	Nr.	Gänge/1"	KernlochØ in mm	UNF	Nr.	Gänge/1"	KernlochØ in mm		
M	1,0	0,25	0,88	MF	3	0,35	2,85	UNC	4	40	2,55	UNF	2	64	2,00
M	1,1	0,25	1,00	MF	4	0,50	3,75	UNC	6	32	3,15	UNF	4	48	2,60
M	1,2	0,25	1,08	MF	5	0,50	4,75	UNC	8	32	3,80	UNF	6	40	3,20
M	1,4	0,30	1,25	MF	6	0,50	5,75	UNC	10	24	4,35	UNF	8	36	3,85
M	1,6	0,35	1,45	MF	6	0,75	5,65	UNC	1/4"	20	5,75	UNF	10	32	4,45
M	1,8	0,35	1,65	MF	8	0,75	7,65	UNC	5/16"	18	7,30	UNF	1/4"	28	5,95
M	2,0	0,40	1,80	MF	8	1,00	7,55	UNC	3/8"	16	8,80	UNF	5/16"	24	7,45
M	2,5	0,45	2,30	MF	10	1,00	9,55	UNC	7/16"	14	10,30	UNF	3/8"	24	9,00
M	3,0	0,50	2,80	MF	10	1,25	9,45	UNC	1/2"	13	11,80	UNF	7/16"	20	10,50
M	3,5	0,60	3,25	MF	12	1,00	11,55	UNC	9/16"	12	13,30	UNF	1/2"	20	12,10
M	4,0	0,70	3,70	MF	12	1,25	11,45	UNC	5/8"	11	14,80	UNF	5/8"	18	15,25
M	5,0	0,80	4,65	MF	12	1,50	11,30	UNC	3/4"	10	17,90	UNF	3/4"	16	18,30
M	6,0	1,00	5,55	MF	14	1,25	13,45	UNC	7/8"	9	20,95	UNF	1"	12	24,45
M	8,0	1,25	7,40	MF	14	1,50	13,30	UNC	1"	8	24,00				
M	10,0	1,50	9,30	MF	16	1,50	15,30								
M	12,0	1,75	11,20	MF	18	1,50	17,30								
M	14,0	2,00	13,10	MF	20	1,50	19,30	G		P	KernlochØ	G		P	KernlochØ
M	16,0	2,00	15,10	MF	22	1,50	21,30	G	1/8"	28	9,25	G	1/2"	14	20,00
M	18,0	2,50	16,90	MF	24	1,50	23,30	G	1/4"	19	12,50	G	3/4"	14	25,50
M	20,0	2,50	18,90	MF	26	1,50	25,35	G	3/8"	19	16,00	G	1"	14	32,00

Hochleistungs-Gewindeformer aus Pulvermetall

High Performance Powder Metal Cold Forming Taps

Geformte Gewinde weisen einen nicht unterbrochenen Faserverlauf (B) auf, bei gleichzeitiger Kaltverfestigung des Werkstoffs. Hierdurch erhöht sich die Festigkeit im Vergleich zu herkömmlichen Gewinden erheblich. Zudem werden Winkelabweichungen vermieden, da der Werkstoff spielfrei verformt wird. Die Gewinde sind über die gesamte Länge toleranzhaltig.

Vorteile:

- Verdoppelung der Schnittgeschwindigkeit ($v_c \times 2$)
- Geformte Gewinde weisen eine erhöhte Festigkeit auf
- Für Grund- und Durchgangslöcher einsetzbar
- Spanlos, keine Probleme mit Spanabfuhr und Entsorgung
- Stabileres Werkzeug durch günstige Werkzeugform

Voraussetzungen:

- Werkstoffe mit guter Kaltverformbarkeit / Dehnbarkeit: Dehnungskoeffizient $> 10\%$
- Hochwertige Kühlschmiermittel: grafithaltige Emulsion oder Öl verwenden
- Durchmesser der Vorbohrung muss größer sein, als bei spanender Gewindeherstellung

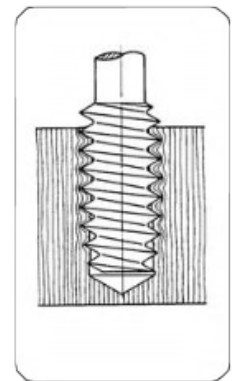

A:

Faserverlauf eines konventionell geschnittenen Gewindes. Die Materialstruktur ist zerstört.

B:

Faserverlauf eines geformten Gewindes. Die Materialstruktur ist erhalten und verdichtet. Das Gewinde ist stabiler und höher belastbar.

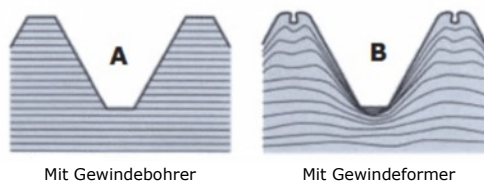

Mit Gewindebohrer









Mit Gewindeformer

Bilder rechts:
Beispiel für Fließ-Loch-Bohren.
Wird in der Blechverarbeitung
angewendet.





Schaftausführungen

Shank Types

ZYL	Zylinderschaft Cylindrical Shank	DIN 1809	Zylinderschaft mit Mitnehmerlappen Cylindrical Shank with Tongue End
 Toleranz im Regelfall h7, auch h8 bis h9 Tolerance normally h7, but also h8 or h9		 Toleranz h7 Tolerance h7	
A	DIN 1835A Zylinderschaft DIN 1835 Form A (HSS, HSS-E Werkzeuge) Cylindrical Shank DIN 1835 Form A (HSS-E Tools)	HA	DIN 6535A Zylinderschaft DIN 6535 Form HA (VHM Werkzeuge) Cylindrical Shank DIN 6535 Form HA (Carbide Tools)
 Toleranz h6, Tolerance h6 Ø 3, 4, 5, 6, 8, 10, 12, 14, 16, 18, 20, 25, 32		 Toleranz h5 oder h6, Tolerance h5 or h6 Ø 3, 4, 5, 6, 8, 10, 12, 14, 16, 18, 20, 25, 32	
B	DIN 1835B Schaft DIN 1835 Form B, seitliche Mitnahmefläche (HSS, HSS-E Werkzeuge) Shank DIN 1835 Form B with flat, Weldon Shank (HSS-E Tools)	HB	DIN 6535B Schaft DIN 6535 Form HB, seitliche Mitnahmefläche (VHM Werkzeuge) Shank DIN 6535 Form HB with flat, Weldon Shank (Carbide Tools)
 Toleranz h6, Tolerance h6 Ø 6, 8, 10, 12, 16, 20, 25, 32		 Toleranz h6, Tolerance h6 Ø 6, 8, 10, 12, 16, 20, 25, 32	
E	DIN 1835E Schaft DIN 1835 Form E, geneigte Mitnahmefläche (HSS, HSS-E Werkzeuge) Shank DIN 1835 Form E with flat, Weldon Shank (HSS-E Tools)	HE	DIN 6535E Schaft DIN 6535 Form HE, geneigte Mitnahmefläche (VHM Werkzeuge) Shank DIN 6535 Form HE with flat, Weldon Shank (Carbide Tools)
 Toleranz h6, Tolerance h6 Ø 6, 8, 10, 12, 16, 20, 25, 32		 Toleranz h6, Tolerance h6 Ø 6, 8, 10, 12, 16, 20, 25, 32	
MK	Morsekegelschaft DIN 228 Form B mit Austreiberlappen Morse Taper Shank DIN 228 Form B with Ejector Drift		
 MK 0 - MK 6 MTS 0 - MTS 6			

Normen für metrische Gewindebohrer

Norms for Metric Taps

DIN 371		Metrisches ISO-Regelgewinde mit verstärktem Schaft (bis M10) Metric ISO Thread with reinforced shank (up to M10)
DIN 376		Metrisches ISO-Regelgewinde mit abgesetztem Schaft (Überlaufschaft) Metric ISO Thread with reduced shank
DIN 374		Metrisches ISO-Feingewinde mit abgesetztem Schaft (Überlaufschaft) Metric ISO Thread with reduced shank

Internationale Maßeinheiten

International Units

Die wichtigsten Einheiten				
Größe	Einheit	Zeichen	Beziehungen zur Einheit	
Länge	Meter	m	1 m	= 100 cm
	Zentimeter	cm	1 cm	= 10 mm
	Millimeter	mm	1 mm	= 1.000 µm
Fläche	Ar	a	1 a	= 10 ² m ²
Winkel	Grad	°	1°	= 17,45 mrad
	Minute	"	1°/60	= 0,291 mrad
	Sekunde	'	1'/60	= 4,85 rad
Masse	Kilogramm	kg	1 kg	= 1.000 g
	Tonne	t	1 t	= 1 Mg = 1.000 kg
Volumen	Liter	l	1 l	= 1 dm ³ = 0,001 m ³
Zeit	Sekunde	s	1 s	= 1.000 ms
	Minute	min	1 min	= 60 s
	Stunde	h	1 h	= 3.600 s
Geschwindigkeit		km/h	1 km/h	= 1/3,6 m/s
			1 m/s	= 3,6 km/h
Stromstärke	Ampere	A	1 A	= 1.000 mA
Druck	Pascal	Pa	1 Pa	= 0,01 mBar
	Bar	bar	1 bar	= 10 ⁵ Pa
Temperatur	Kelvin	K		
Kraft	Newton	N		
Drehmoment	Newtonmeter	Nm		
Leistung	Watt	W		
Energie / Arbeit (Joule) 1 Nm = 1 Ws = 1 J (in Bezug auf die absolute Größe)				
	Newtonmeter	Nm		Mechanische Energieform
	Wattsekunde	Ws		Elektrische Energieform
	Joule	J		Kalorische Energieform

Die wichtigsten Vorsatzzeichen und ihre Anwendung					
Mega	M	= 1.000.000	= 10 ⁶	1 MW	= 1.000.000 W
Kilo	k	= 1.000	= 10 ³	1 kW	= 1.000 W
Hekto	h	= 100	= 10 ²	1 hl	= 100 l
Deka	da	= 10		1 daN	= 10 N
Dezi	d	= 0,1	= 10 ⁻¹	1 dm	= 0,1 m
Zenti	c	= 0,01	= 10 ⁻²	1 cm	= 0,01 m
Milli	m	= 0,001	= 10 ⁻³	1 mm	= 0,001 m
Mikro	µ	= 0,000001	= 10 ⁻⁶	1 µm	= 0,000001 m

Die wichtigsten Umrechnungen zwischen den bisherigen und den neuen Einheiten			
Neue Einheiten zur bisherigen Einheit:		Bisherige Einheit zur neuen Einheit:	
1 N	= 0,102 kp	1 kp	= 9,81 N
1 Nm	= 0,102 kpm (= 1 Joule)	1 kpm	= 9,81 Nm
1 W	= 0,102 kpm/s (1 J/s)	1 kpm/s	= 9,81 W
1 kW	= 1,36 PS	1 PS	= 0,736 kW
1 kW	= 860 kcal/h	1 kcal/h	= 1,16 · 10 ⁻³ kW = 0,00116 kW
1 J	= 0,102 kp/m ²	1 kpm	= 9,81 J
1 J	= 0,239 cal	1 cal	= 4,19 J
1 Pa	= 0,102 kp/m ²	1 kp/m ²	= 9,81 Pa = 9,81 N/m ²
K	= °C + 273,15		

In der Praxis rechnet man mit folgenden Werten: 1 kp ~ 10 N - 1 N ~ 0,1 kp

Umrechnungstabelle Zoll in Millimeter

Conversion Table Imperial to Metric

Nach DIN 4890; 1 Zoll = 25,400 mm (s. DIN 4890 - gerundet)

Zoll	0	1	2	3	4	5	6	7	8	9	10	11	12
Zollbrüche	mm	mm	mm	mm	mm	mm	mm	mm	mm	mm	mm	mm	mm
0	0	25,400	50,800	76,200	101,600	127,00	152,40	177,80	203,20	228,60	254,00	279,40	304,80
1/16	1,588	26,988	52,388	77,788	103,188	128,59	153,99	179,39	204,79	230,19	255,59	280,99	306,39
1/8	3,175	28,575	53,975	79,375	104,775	130,18	155,58	180,98	206,38	231,78	257,18	282,58	307,98
3/16	4,763	30,163	55,563	80,963	106,363	131,76	157,16	182,56	207,96	233,36	258,76	284,16	309,56
1/4	6,350	31,750	57,150	82,550	107,950	133,35	158,75	184,15	209,55	234,95	260,35	285,75	311,15
5/16	7,938	33,338	58,738	84,138	109,538	134,94	160,34	185,74	211,14	236,54	261,94	287,34	312,74
3/8	9,525	34,925	60,325	85,725	111,125	136,53	161,93	187,32	212,73	238,13	263,53	288,93	314,33
7/16	11,113	36,513	61,913	87,313	112,713	138,11	163,51	188,91	214,31	239,71	265,11	290,51	315,91
1/2	12,700	38,100	63,500	88,900	114,300	139,70	165,10	190,50	215,90	241,30	266,70	292,10	317,50
9/16	14,288	39,688	65,088	90,488	115,888	141,29	166,69	192,09	217,49	242,89	268,29	293,69	319,09
5/8	15,875	41,275	66,675	92,075	117,475	142,88	168,28	193,68	219,08	244,48	269,88	295,28	320,68
11/16	17,463	42,863	68,263	93,663	119,063	144,46	169,86	195,26	220,66	246,06	271,46	296,86	322,26
3/4	19,050	44,450	69,850	95,250	120,650	146,05	171,45	196,85	222,25	247,65	273,05	298,45	323,85
13/16	20,638	46,038	71,438	96,838	122,238	147,64	173,04	198,44	223,84	249,24	274,64	300,04	325,44
7/8	22,225	47,625	73,025	98,425	123,825	149,23	174,63	200,03	225,43	250,83	276,23	301,63	327,03
15/16	23,813	49,213	74,613	100,013	125,413	150,81	176,21	201,61	227,01	252,41	277,81	303,21	328,61

Umrechnungstabelle Millimeter in Zoll

Conversion Table Metric to Imperial

Dezimal-Teilung - Umrechnungswert: 1 Zoll = 25,4 mm

mm in Zoll	0	1	2	3	4	5	6	7	8	9
mm										
0	0	0.03937"	0.07874"	0.11811"	0.15748"	0.19685"	0.23622"	0.27559"	0.31496"	0.35433"
10	0.39370"	0.43307"	0.47244"	0.51181"	0.55118"	0.59055"	0.62992"	0.66929"	0.70866"	0.74809"
20	0.78740"	0.82677"	0.86614"	0.90551"	0.94488"	0.98425"	1.02362"	1.06299"	1.10236"	1.14173"
30	1.18110"	1.22047"	1.25984"	1.29921"	1.33858"	1.37795"	1.41732"	1.45669"	1.49606"	1.53543"
40	1.57480"	1.61417"	1.65354"	1.69291"	1.73228"	1.77165"	1.81102"	1.85039"	1.88976"	1.92913"
50	1.96851"	2.00787"	2.04724"	2.08661"	2.12598"	2.16535"	2.20472"	2.24409"	2.28346"	2.32283"
60	2.36221"	2.40157"	2.44095"	2.48031"	2.51968"	2.55905"	2.59842"	2.63779"	2.67716"	2.71653"
70	2.75591"	2.79527"	2.83465"	2.87401"	2.91338"	2.95275"	2.99212"	3.03149"	3.07086"	3.11024"
80	3.14961"	3.18897"	3.22835"	3.26772"	3.30709"	3.34646"	3.38583"	3.42520"	3.46457"	3.50394"
90	3.54331"	3.58268"	3.62205"	3.66142"	3.70079"	3.74016"	3.77953"	3.81890"	3.85827"	3.89764"



Vergleichstabelle der Härte und Zugfestigkeit*

Comparative Table of Hardness and Resistance

Vickershärte HV 30	Brinellhärte HB 30	Rockwellhärte		Zugfestigkeit N/mm ²
		HRB	HRC	
80	80	36	-	270
85	85	42	-	290
90	90	47	-	310
95	95	52	-	320
100	100	56	-	340
105	105	60	-	360
110	110	63	-	380
115	115	66	-	390
120	120	69	-	410
125	125	72	-	420
130	130	74	-	440
135	135	76	-	460
140	140	78	-	470
145	145	80	-	490
150	150	82	-	500
155	155	84	-	520
160	160	85	-	540
165	165	87	-	550
170	170	88	-	570
175	175	90	-	590
180	180	91	-	600
185	185	92	-	620
190	190	93	-	640
195	195	94	-	660
200	200	95	-	670
205	205	96	-	680
210	210	97	-	710
215	215	98	-	720
220	220	98	-	730
225	225	99	-	750
230	230	-	19	760
235	235	-	20	780
240	240	-	21	800
245	245	-	22	820
250	250	-	23	830
255	255	-	24	850
260	260	-	25	870
265	265	-	25	880
270	270	-	26	900
275	275	-	27	920
280	280	-	28	940
285	285	-	28	950
290	290	-	29	970
295	295	-	30	990
300	300	-	30	1010
310	310	-	32	1040
320	320	-	33	1080
330	330	-	34	1110
340	340	-	35	1140

Vickershärte HV 30	Brinellhärte HB 30	Rockwellhärte		Zugfestigkeit N/mm ²
		HRB	HRC	
350	350	-	36	1170
360	359	-	37	1200
370	368	-	38	1230
380	376	-	39	1260
390	385	-	40	1290
400	392	-	41	1320
410	400	-	42	1350
420	408	-	42	1380
430	415	-	43	1410
440	423	-	44	1430
450	430	-	45	1460
460	-	-	46	-
470	-	-	46	-
480	-	-	47	-
490	-	-	48	-
500	-	-	48	-
510	-	-	49	-
520	-	-	50	-
530	-	-	50	-
540	-	-	51	-
550	-	-	52	-
560	-	-	52	-
570	-	-	53	-
580	-	-	53	-
590	-	-	54	-
600	-	-	54	-
610	-	-	55	-
620	-	-	56	-
630	-	-	56	-
640	-	-	57	-
650	-	-	57	-
660	-	-	58	-
670	-	-	58	-
680	-	-	59	-
690	-	-	59	-
700	-	-	60	-
720	-	-	60	-
740	-	-	61	-
760	-	-	62	-
780	-	-	63	-
800	-	-	64	-
820	-	-	64	-
840	-	-	65	-
860	-	-	66	-
880	-	-	66	-
900	-	-	67	-
920	-	-	68	-
940	-	-	68	-

* Alle mittels verschiedener Härteprüfverfahren an verschiedenen Werkstoffen ermittelten Härtewerte sind nur annähernd vergleichbar.

Artikelverzeichnis

Number Index

Artikel-Nr.	Seite	Artikel-Nr.	Seite	Artikel-Nr.	Seite	Artikel-Nr.	Seite
111 103	D 34	123 437	C 5	154 700	F 11	411 310	D 32
111 108	D 35	123 440	B 9	154 800	F 13	411 320	D 33
111 130	D 36	123 450	B 10	154 910	F 13	411 330	D 33
111 150	D 37	123 451	B 10	155 200	F 19	411 340	D 33
111 500	D 38	123 460	B 14	155 206	F 18	513 110	E 17
113 150	E 24	123 461	B 14	155 600	F 7	513 120	E 17
113 160	E 19	123 470	B 13	155 607	F 8	514 110	E 18
113 170	E 20	123 480	A 10	155 608	F 8	514 120	E 18
113 180	E 14	123 490	A 10	155 800	F 20	551 100	I 36
113 181	E 12	123 510	A 11	155 806	F 20	552 140	K 1
113 187	E 15	123 530	A 11	157 007	G 7	552 345	K 11
113 190	E 16	123 540	A 11	300 502	M 17	552 480	I 37
113 199	E 13	123 550	A 11	306 100	M 13	552 545	K 11
113 200	E 19	123 560	C 3	306 300	M 13	552 580	I 37
113 210	E 20	123 567	C 3	311 602	M 16	553 442	K 5
113 270	E 11	123 580	B 12	312 800	M 15	554 640	K 5
114 740	E 21	123 587	B 15	312 900	M 15	572 340	K 6
114 700	E 22	123 590	B 11	313 400	M 14	572 540	K 6
114 750	E 21	123 591	B 11	324 500	M 15	573 340	K 7
114 760	E 21	123 600	B 15	324 600	M 16	573 440	K 7
114 780	E 22	123 601	B 15	334 300	M 14	574 416	K 2
114 785	E 23	123 604	B 16	360 120	M 8	574 426	K 9
123 520	A 11	123 620	A 15	360 125	M 11	574 430	K 4
123 110	A 4	123 630	A 16	360 150	M 8	574 440	K 8
123 130	A 5	123 640	B 7	360 165	M 11	574 446	K 10
123 140	A 6	123 650	A 16	360 190	M 7	574 476	K 3
123 160	A 7	123 660	A 17	360 210	M 9	574 516	K 2
123 180	A 4	123 670	A 17	360 310	M 9	574 526	K 9
123 200	A 8	124 607	B 17	360 420	M 6	574 530	K 4
123 210	A 7	124 617	B 17	360 421	M 1	574 540	K 8
123 230	A 8	124 627	B 17	360 450	M 6	574 546	K 10
123 260	A 6	124 907	B 18	360 490	M 5	575 430	K 3
123 280	A 13	124 917	B 18	360 491	M 1	611 110	D 13
123 286	A 13	124 927	B 18	360 510	M 10	611 120	D 12
123 290	A 12	153 000	F 14	360 520	M 4	611 121	D 1
123 296	A 12	153 900	F 16	360 525	M 12	613 610	E 1
123 300	A 14	153 010	F 14	360 550	M 4	613 110	E 8
123 306	A 14	153 080	F 14	360 555	M 12	613 120	E 8
123 310	B 9	153 300	F 14	360 620	M 2	613 150	E 23
123 320	B 13	153 400	F 14	360 650	M 3	613 180	E 5
123 340	A 9	153 700	F 15	360 721	M 10	613 181	E 3
123 350	A 9	153 950	F 16	411 280	D 32	613 189	E 4
123 370	B 8	153 980	F 17	411 111	D 30	613 199	E 4
123 371	B 8	154 600	F 12	411 117	D 31	613 270	E 2
123 380	B 12	154 030	F 16	411 120	D 24	613 280	E 9
123 381	B 12	154 045	F 16	411 121	D 22	613 281	E 9
123 384	B 16	154 100	F 17	411 127	D 25	613 290	E 7
123 390	B 8	154 303	F 11	411 140	D 27	613 610	E 1
123 397	B 11	154 304	F 10	411 147	D 28	613 615	E 6
123 400	C 4	154 607	F 10	411 155	D 26	613 620	E 6
123 407	C 4	154 610	F 9	411 180	D 29	613 667	E 10
123 410	C 6	154 620	F 9	411 221	D 23	613 677	E 10
123 417	C 6	154 630	F 12	411 227	D 23	623 200	B 1
123 420	A 15	154 650	F 12	411 290	D 32	623 267	A 2
123 430	C 5	154 660	F 13	411 300	D 32	623 360	A 1

Artikelverzeichnis

Number Index

Artikel-Nr.	Seite	Artikel-Nr.	Seite	Artikel-Nr.	Seite	Artikel-Nr.	Seite
623 367	A 1	668 460	G 10	698 509	H 20	751 040	I 13
623 370	A 3	668 480	G 8	698 510	H 21	751 050	I 16
623 377	A 3	668 490	G 9	731 180	D 14	751 065	I 25
623 390	B 2	668 507	H 2	750 074 HC	I 2	751 066	I 26
623 397	B 3	668 509	H 2	750 037	I 6	751 077	I 20
623 407	C 2	668 510	H 3	750 074	I 2	751 078	I 20
623 408	C 1	668 511	H 2	360 620 01	M 2	751 079	I 21
623 417	C 2	668 515	I 1	360 650 01	M 3	751 100	I 3
623 480	B 1	668 521	H 16	731 170 HC	D 14	751 105	I 5
623 490	B 2	668 527	H 17	750 033	I 6	751 110	I 4
623 491	B 2	668 529	H 16	750 035	I 6	751 151	I 10
623 492	B 3	668 537	H 7	751 023 S	I 12	751 190	I 18
623 497	B 3	668 550	G 13	751 024 A	I 7	751 194	I 18
623 500	B 4	672 000	J 13	751 025 A	I 8	751 653	I 11
623 501	B 4	673 000	J 13	751 060 HC	I 24	751 683	I 11
623 502	B 5	678 090	G 4	751 065 HC	I 25	751 900	I 19
623 507	B 5	678 500	H 4	751 066 HC	I 26	751 902	I 19
623 511	B 6	678 507 F	H 6	751 070	I 30	752 425	J 10
623 512	B 6	678 527 F	H 19	751 070 GHC	I 30	752 525	J 10
623 537	A 2	678 533	H 8	751 070 GHC	I 29	752 555	J 12
623 580	B 4	678 040	G 5	751 070 HC	I 29	752 853	H 14
623 587	B 5	678 060	G 15	751 070 M	I 30	752 854	H 14
624 907	B 19	678 063	G 15	751 070 MHC	I 29	752 855	H 15
652 300	F 6	678 070	G 16	751 080	I 28	752 951	H 10
653 300	F 6	678 073	G 16	751 080 G	I 28	752 952	H 12
654 303	F 2	678 088	G 5	751 080 GHC	I 27	756 424	J 11
654 304	F 1	678 089	G 4	751 080 HC	I 27	756 026	J 5
654 600	F 2	678 092	G 6	751 080 M	I 28	756 524	J 11
654 607	F 1	678 095	G 5	751 080 MHC	I 27	757 411	J 1
654 650	F 3	678 460	G 10	751 085	I 34	757 412	J 2
654 657	F 3	678 480	G 8	751 085 HC	I 33	757 414	J 3
654 660	F 4	678 490	G 9	751 085 M	I 34	757 032	I 9
654 667	F 4	678 507	H 5	751 085 MHC	I 33	757 311	J 1
654 910	F 5	678 509	H 5	751 090	I 32	757 312	J 2
654 917	F 5	678 510	H 6	751 090 G	I 32	757 345	J 5
655 200	F 18	678 511	H 5	751 090 GHC	I 31	757 346	J 4
658 900	D 21	678 521	H 18	751 090 HC	I 31	757 420	J 8
659 220	D 17	678 522	H 15	751 090 M	I 32	757 424	J 8
659 221	D 17	678 527	H 19	751 090 MHC	I 31	757 425	J 9
659 230	D 18	678 529	H 18	751 100 S	I 3	757 445	J 5
659 231	D 19	678 530	H 9	751 110 S	I 4	757 446	J 4
659 240	D 20	678 537	H 8	751 150	I 10	757 458	J 9
662 640	J 14	678 550	G 14	751 000	I 13	757 511	J 1
664 640	J 14	678 560	G 12	751 001	I 5	757 512	J 2
668 090	G 1	690 854 X	G 18	751 010	I 15	757 514	J 3
668 500	H 1	690 856 X	G 18	751 020	I 12	757 521	J 6
668 507 F	H 3	690 859 X	G 18	751 023	I 12	757 531	J 6
668 527 F	H 17	690 854	G 17	751 024	I 7	757 546	J 4
668 533	H 7	690 856	G 17	751 025	I 8	757 710	J 7
668 040	G 2	690 859	G 17	751 027	I 14	757 720	J 7
668 088	G 2	698 500	H 20	751 030	I 15	761 531	D 7
668 089	G 1	698 507 F	H 21	751 031	I 16	761 230	D 8
668 092	G 3	698 527 F	H 22	751 032	I 9	761 232	D 16
668 095	G 2	698 529	H 22	751 034	I 17	761 330	D 9
668 410	G 11	698 507	H 20	751 035	I 17	761 530	D 10

Artikelverzeichnis

Number Index

Artikel-Nr.	Seite	Artikel-Nr.	Seite	Artikel-Nr.	Seite	Artikel-Nr.	Seite
761 540	D 15	791 065	I 23	NBT-M	L 8	SRC	L 16
761 630	D 11	791 067	I 22	NDFK-M	L 15	SRH	L 19
761 631	D 7	791 069	I 23	NF-M	L 8	SRH-M WSP	L 20
761 730	D 11	792 644	I 35	NM-M	L 4	SRH-NPT WSP	L 20
761 731	D 7	792 645	I 35	NS-MUN	L 2	SRH-UN WSP	L 20
761 821	D 1	EB-M	L 10	SR	L 16	SRHM	L 19
761 823	D 2	FC-NPT	L 14	SR-BSPT WSP	L 18	XB-BSPT	L 12
761 825	D 3	MM-M	L 3	SR-G WSP	L 17	XB-G	L 11
761 827	D 4	MS-G	L 1	SR-M WSP	L 17	XB-NPSF	L 13
761 828	D 5	MS-M	L 1	SR-NPT WSP	L 18	XB-NPT	L 13
761 832	D 6	NB-M	L 5	SR-NPTF WSP	L 18	XB-NPTF	L 14
761 835	D 6	NB-UN	L 9	SR-PG WSP	L 18	XB-PG	L 12
791 060	I 22	NBK-M	L 7	SR-UN WSP	L 17	XBT-G	L 11

passion for precision
[Leidenschaft für Präzision]



**SPPW - Spanabhebende
Präzisionswerkzeuge GmbH**

Gottlieb-Daimler-Str. 10
35423 Lich - GERMANY

T: +49 6404 6634-0
F: +49 6404 6634-21
E: info@sppw.de
W: www.sppw.de